

Operational Experience of Target Systems for Neutrino Facilities

Chris Densham

STFC Rutherford Appleton Laboratory

2 May 2011

NuMI at Fermilab

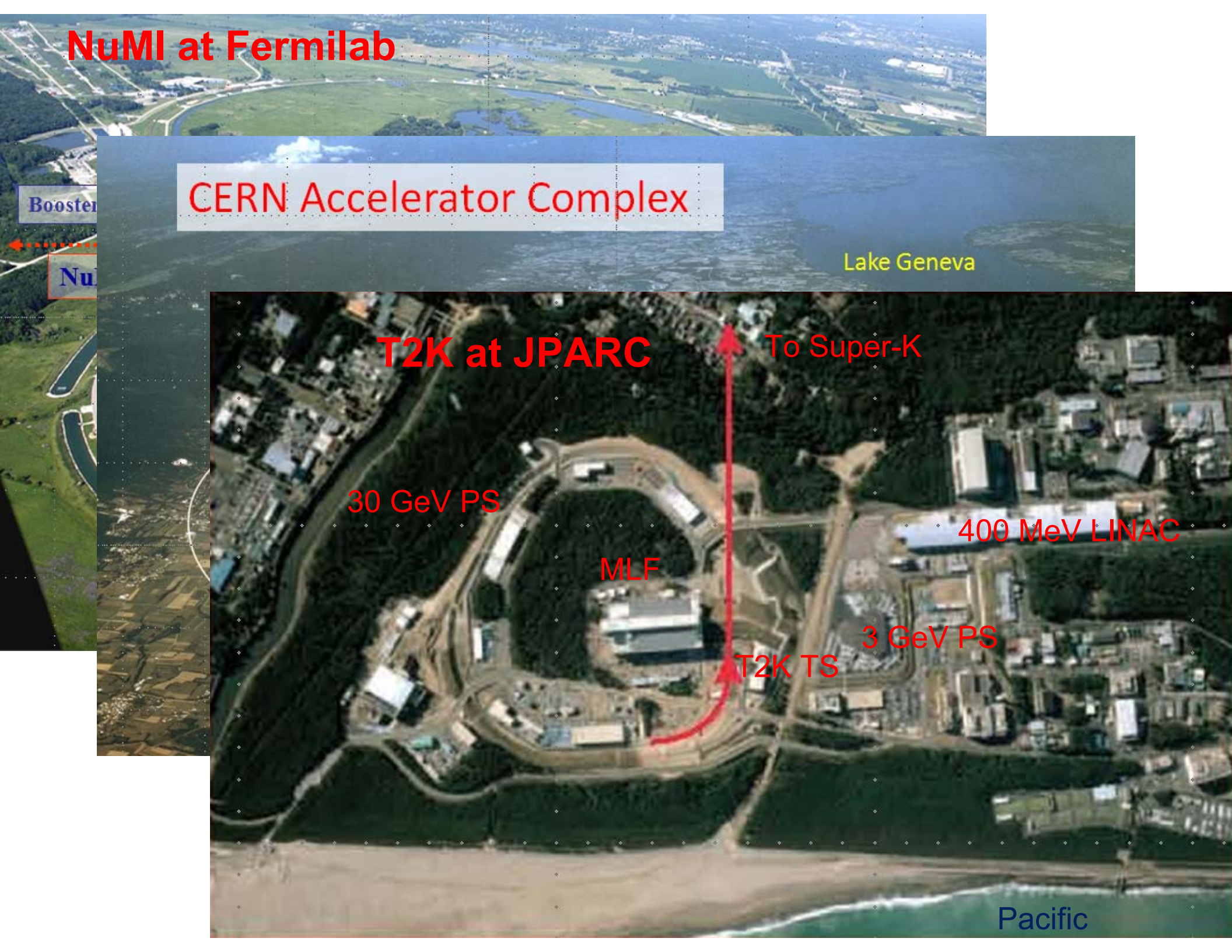

CERN Accelerator Complex

Lake Geneva

Booster

NuMI

T2K at JPARC

To Super-K

30 GeV PS

MLF

400 MeV LINAC

3 GeV PS

T2K TS

Pacific

A few comparative parameters

	NuMI	CNGS	T2K
Beam energy	120 GeV	400 GeV	30 GeV
Beam cycle	2.2 s	6 s	2.1 s
Spill length	10 μ s	2 x 10.5 μ s	4.2 μ s
Design beam power	400 kW	750 kW	750 kW
Maximum beam power to date	375 kW	320 kW	135 kW
Beam size (rms)	1.1 mm	0.5 mm	4.2 mm
Physics	ν_{μ} disappearance	$\nu_{\mu} \rightarrow \nu_{\tau}$ appearance	$\nu_{\mu} \rightarrow \nu_e$ appearance, ν_{μ} disappearance
First beam	2005	2006	2009

NuMI Beam Performance

Total NuMI protons to 00:00 Monday 31 May 2010

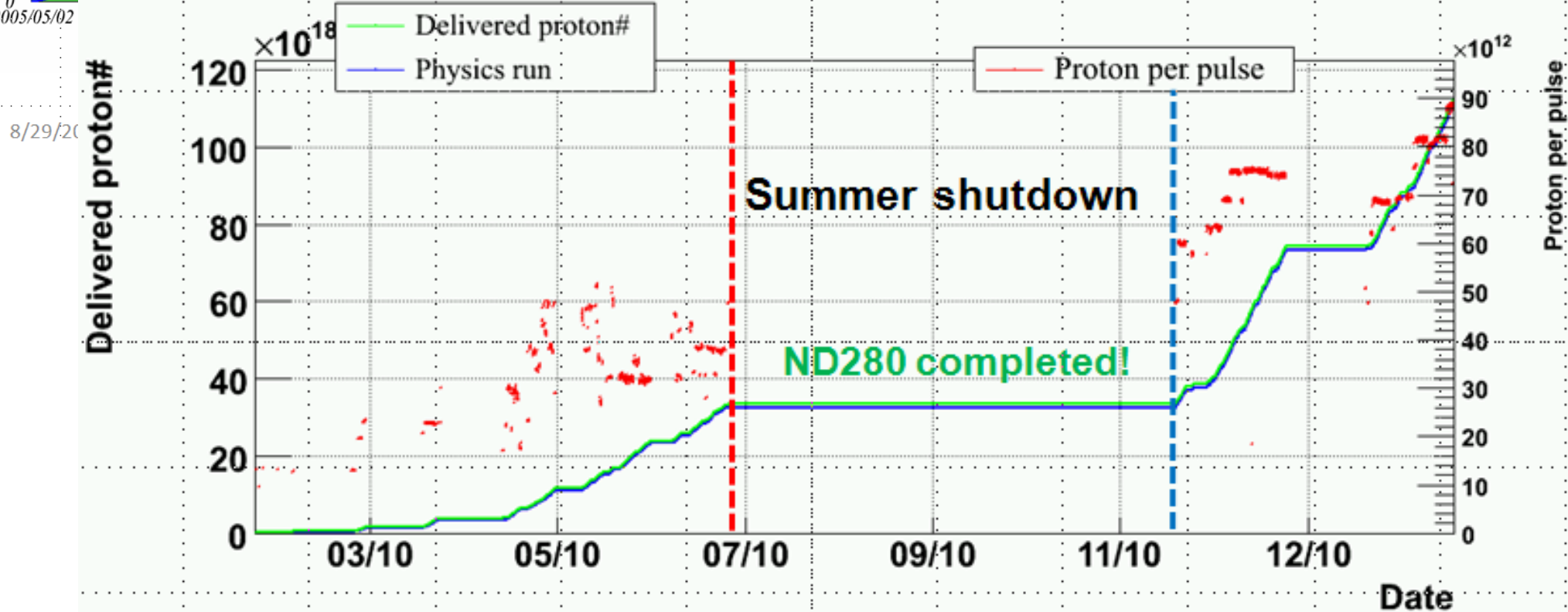
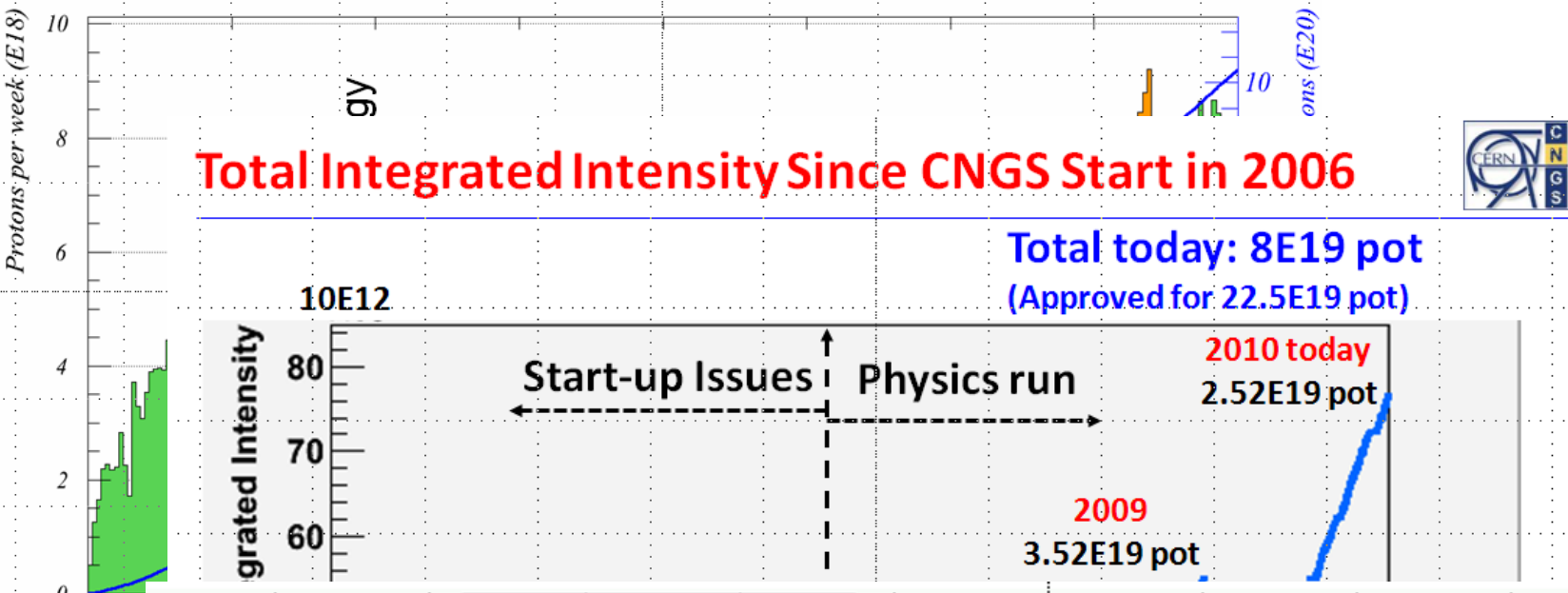

Selected target station issues

	NuMI/NOvA	CNGS	T2K
Environment	Air (helium around target)	Air (helium around target)	Helium (separate to target helium)
Pros	<ul style="list-style-type: none"> • Simple - no containment • Access to target/horn possible 	<ul style="list-style-type: none"> • Simple - no containment 	<ul style="list-style-type: none"> • Clean environment • No corrosion expected inside target/DV vessel
Cons	<ul style="list-style-type: none"> • Nitric acid generation - hydrogen embrittlement of steels • Air activation 	=>	<ul style="list-style-type: none"> • Slow access to target - long component lifetimes necessary.
Target exchange methods: separate target/horn exchange possible in all cases	Partially remote (target carrier) / local personnel shielding	5-target 'magazine' - Complete assemblies replaced by crane	Complete assemblies lifted by crane to remote maintenance area
Pros	<ul style="list-style-type: none"> • Flexible • Economic • Can change targets quickly in TS 	<ul style="list-style-type: none"> • Quick to change targets in principle 	<ul style="list-style-type: none"> • Controlled doses to personnel for planned tasks • Good access
Cons	<ul style="list-style-type: none"> • Difficult to control doses to personnel during repairs (OK for full replacement) 	<ul style="list-style-type: none"> • mechanism can seize requiring entire magazine change 	<ul style="list-style-type: none"> • Significant preparation work and time required

Selected target station issues

	NuMI/NOvA	CNGS	T2K
Economics	All facilities constructed and operated with modest resources (e.g. compared with neutron facilities). Operation is parasitic or shared. This has required compromise in both design and operation		
Economics: the plus side:	Considerable technical collaboration and cooperation between all facilities, notwithstanding any competition over scientific goals		

Target Basics (J.Hylen)

Long enough (2 interaction lengths) to interact most protons

Dense enough that $2 l_{\text{int}}$ fits in focusing system depth-of-field

Radius: $R_{\text{target}} = 2.3 \text{ to } 3 R_{\text{beam}}$ (minimize gaussian tails missing target)

Narrow enough that pions exit the sides without re-absorption

(but for high E_{proton} and low E_{π} , secondary shower can help)

High pion yield (but to first order, n flux a beam power)

Radiation hard

Withstand high temperature

High strength (withstand stress from fast beam pulse)

Low density (less energy deposition density, hence less stress; don't re-absorb pions)

Low dE/dx (but not much variation between materials)

High heat capacity (less stress induced by the dE/dx)

Low thermal expansion coefficient (less stress induced by the dE/dx)

Low modulus of elasticity (less stiff material does not build up stress)

Reasonable heat conductivity

Reasonable electrical conductivity (monitor target by charge ejection)

CNGS, NuMI, T2K all using graphite

CNGS Challenges and Design Criteria

- **High Intensity, High Energy Proton Beam (500kW, 400GeV/c)**
 - Induced radioactivity
 - In components, shielding, fluids, etc...
 - Intervention on equipment 'impossible'
 - Remote handling by overhead crane
 - Replace broken equipment, no repair
 - Human intervention only after long 'cooling time'
 - Design of equipment: compromise
 - E.g. horn inner conductor: for neutrino yield: thin tube, for reliability: thick tube
- **Intense Short Beam Pulses, Small Beam Spot**
(up to 3.5×10^{13} per 10.5 ms extraction, < 1 mm spot)
 - Thermo mechanical shocks by energy deposition (designing target rods, thin windows, etc...)

? Proton beam: Tuning, Interlocks!

? most challenging zone: Target Chamber (target–horn–reflector)

Target technology solutions

	NuMI/NOvA	CNGS	T2K
Target material	Graphite: POCO ZXF-5Q	Carbon: Various	Graphite: IG 430
Cooling	Water (forced convection)	Natural convection (He)	Helium (forced convection)
Pros	<ul style="list-style-type: none"> •Efficient (High HTC) •Simple system 	<ul style="list-style-type: none"> •Passive •Simple 	<ul style="list-style-type: none"> •Low pion absorption •No shock issues •Allows graphite to run hot (longer lifetime) •Reduced activity
Cons	<ul style="list-style-type: none"> •Water hammer, cavitation •Hydrogen + tritium + water activation • Some pion absorption in coolant 	<ul style="list-style-type: none"> •Only possible for low deposited heat loads 	<ul style="list-style-type: none"> •High flow rate (large compressors etc) •Complex plant •Possible contamination from failed target?

Elevation View of NuMI/MINOS on Fermilab Site

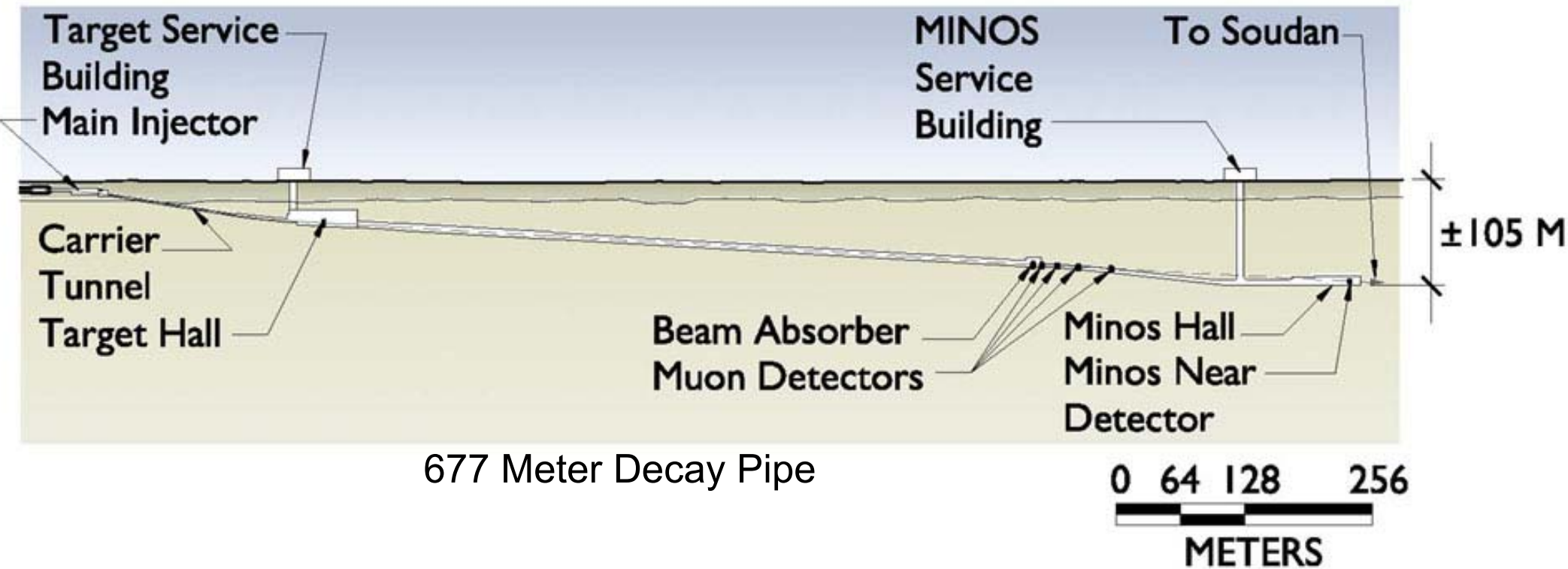

NuMI MINOS target (J.Hylen)

2 int. length long; narrow so pions get out sides without re-interacting



Graphite Fin Core
6.4 mm wide

Water cooling tube

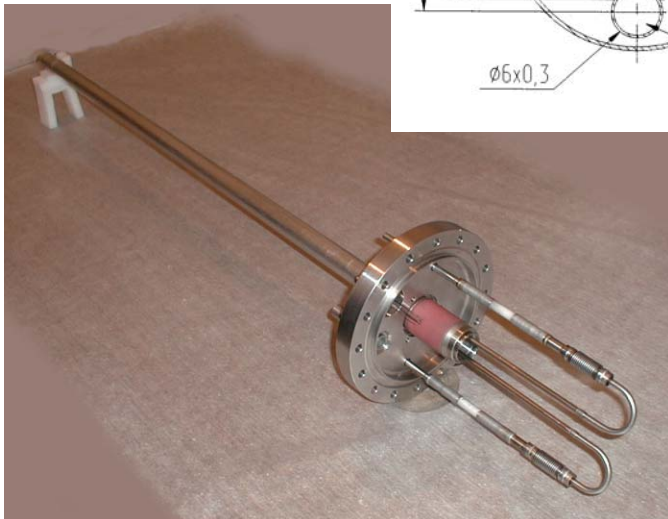
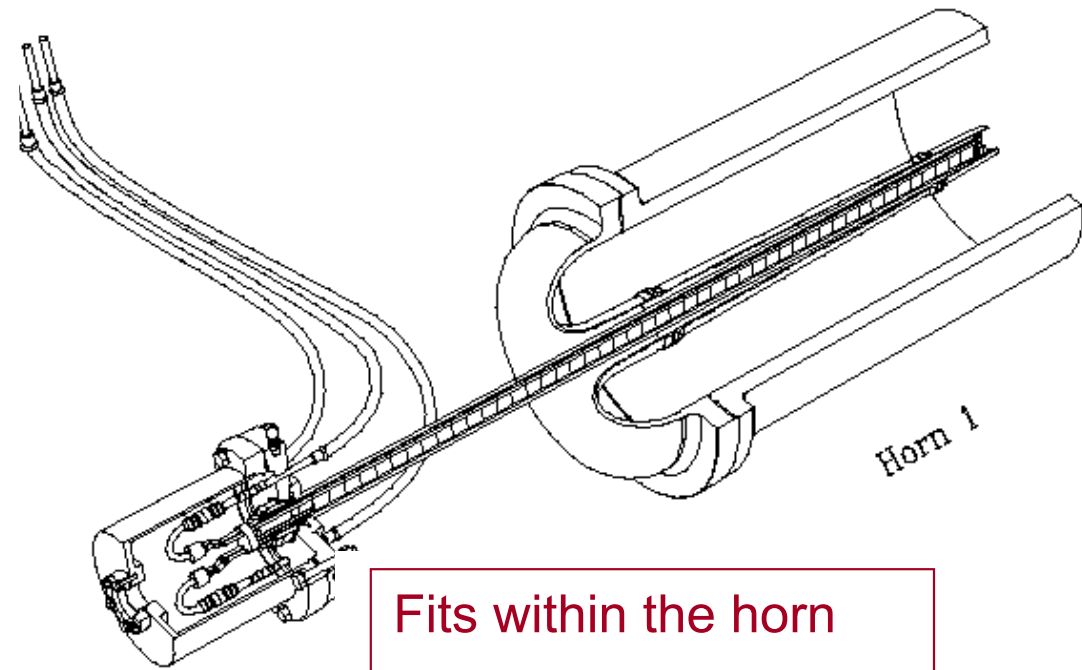
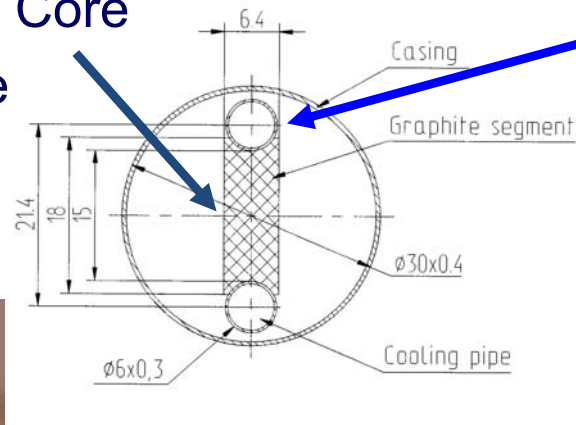

Effects of pulsed beams (I): NuMI target



Recent NuMI target pipework failure of joint between martensitic pipes and austenitic annular manifold (courtesy of P.Hurh)

Effects of pulsed beams: NuMI target

**Beam induced temperature jump
at the downstream end of the target ($z = 94$ cm)**

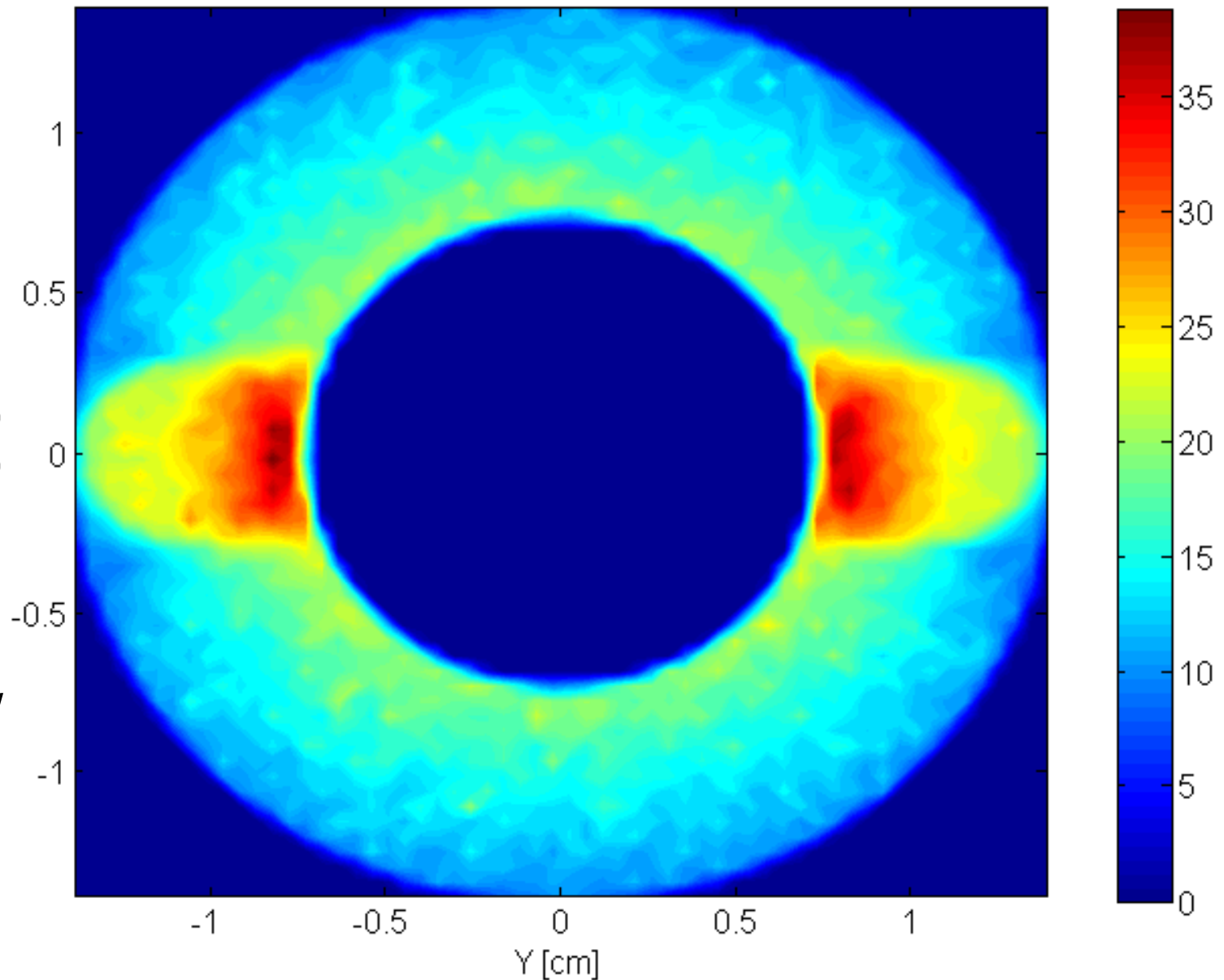

FLUKA simulation of
NuMI target + water +
pipework by Otto
Caretta and Tristan
Davenne
(Supported by P.Hurh /
FNAL)

Effects of pulsed beams: NuMI target

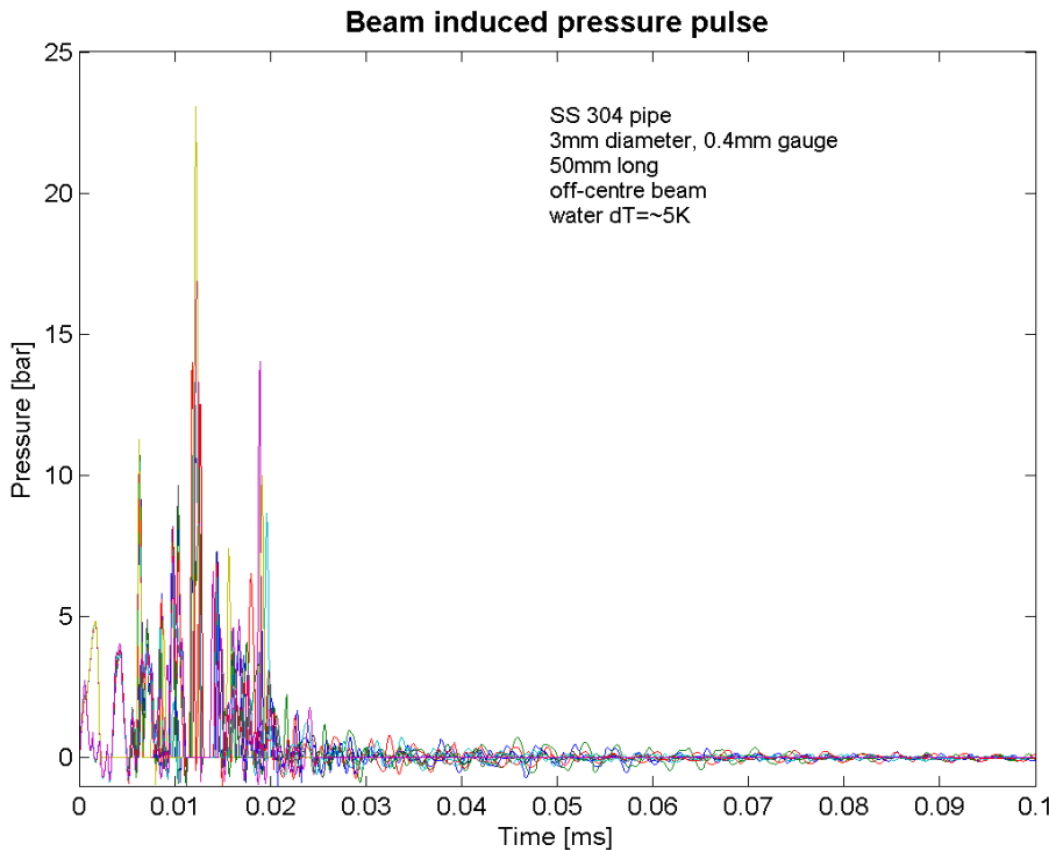

- Pulsed beam induced pressure transients in water contained within SS304 pipe
- Pipe expands more than water:
 - Possibility of cavitation
- Also: possible fatigue at joint between SS304 and SS410

- **Possible solution: replace stainless pipes with titanium alloy:**
 - **lower ΔT**
 - **lower expansion coefficient (close to graphite)**
 - **no harder to join to graphite**
 - **lower stresses**
 - **high strength**

Side elevation of CNGS tunnel layout

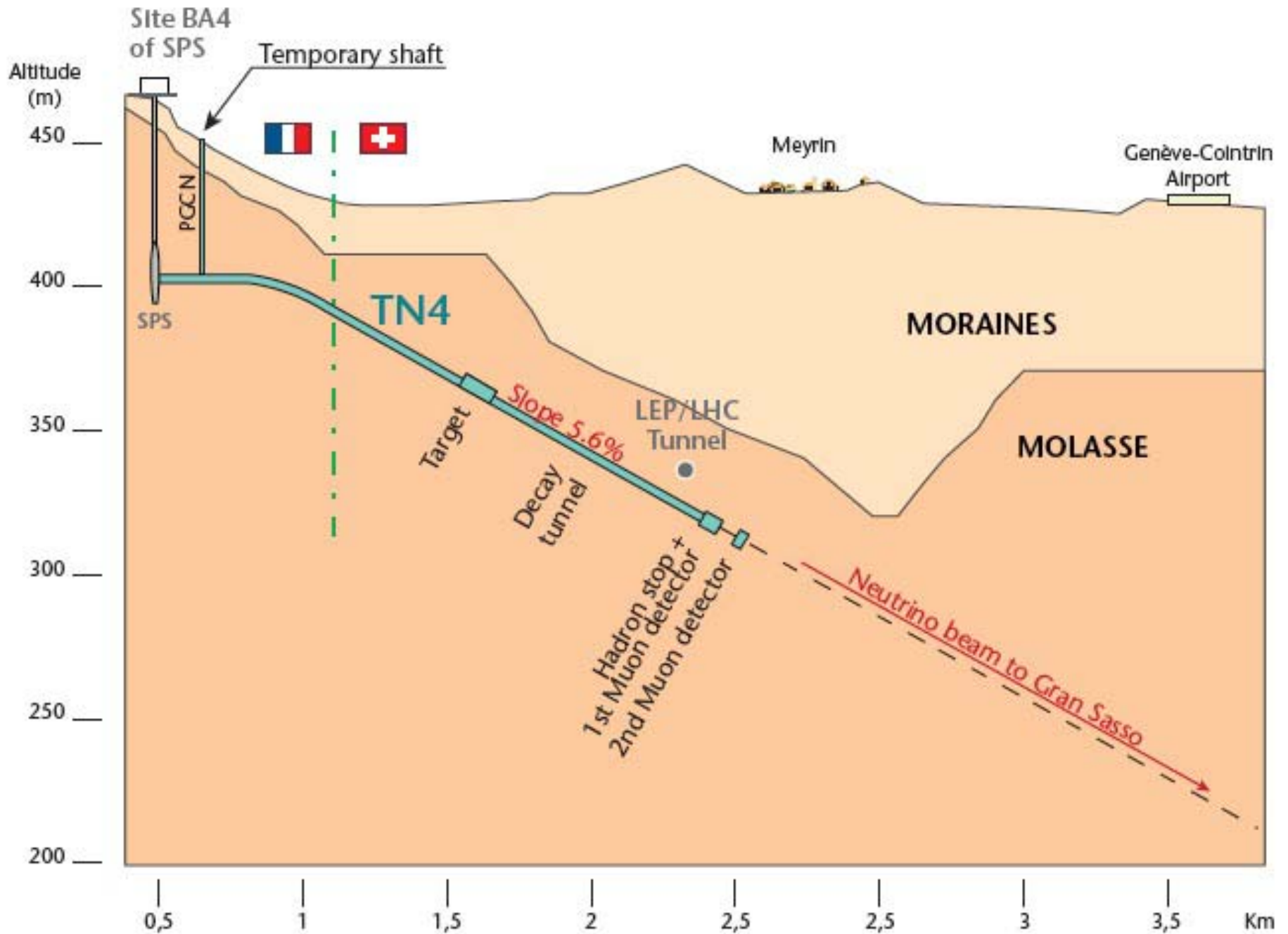

CNGS Target Unit (Luca Bruno et al)

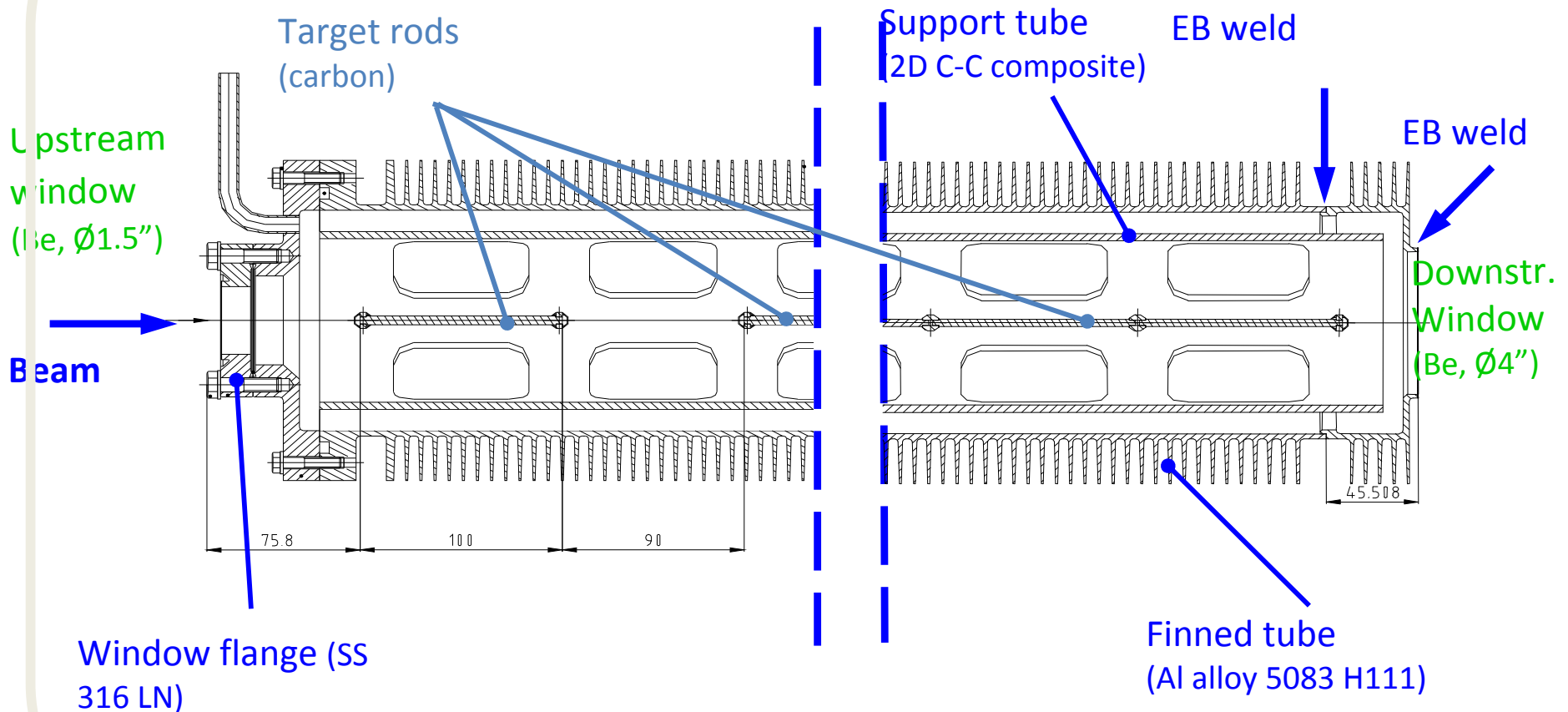

The target unit is conceived as a static sealed system filled with 0.5 bar of He.

The tube has annular fins to enhance convective heat transfer.

Light materials are used to limit the heat load.

Target magazine: 1 unit used, 4 in-situ spares

CNGS Target

13 graphite rods, each 10cm long,

$\varnothing = 5\text{mm}$ and/or 4mm

2.7mm interaction length

Ten targets (+1 prototype) have been built. \square Assembled in two magazines.

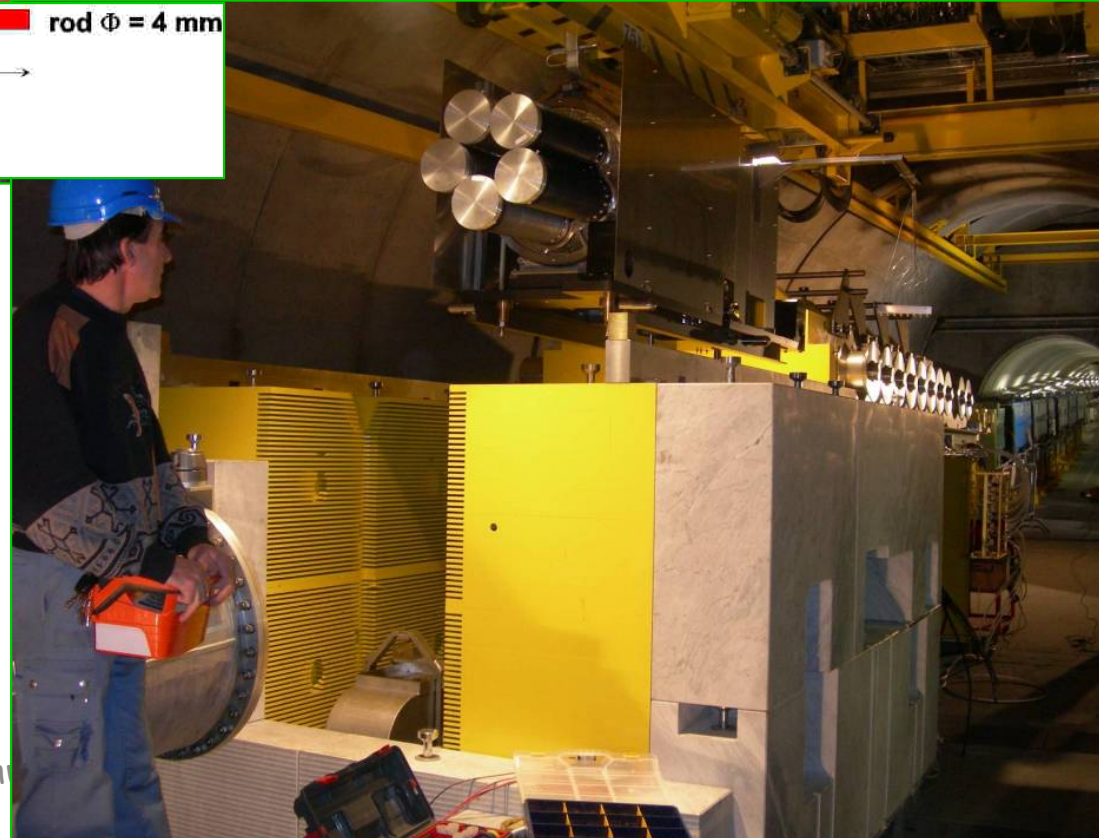

Edda Gsch

Effects of pulsed beams II: CNGS target

Estimated Target Stress

May 2005 - Measured material properties

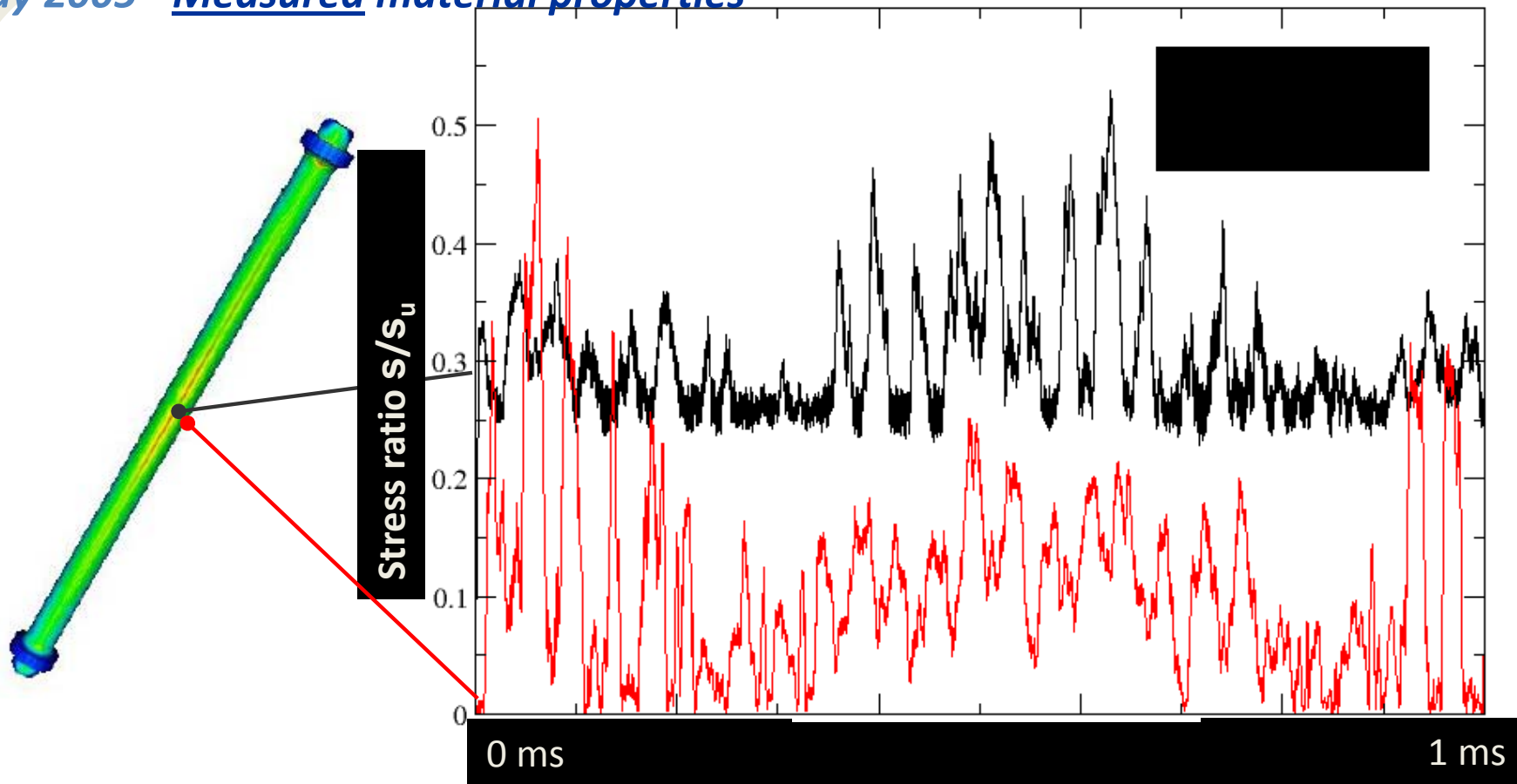

Based on the measured material properties, the estimated stress values are at most 50% of the limit value under worst loading conditions (1.5mm off-axis, ultimate proton spill on a cold baseline target without damping).

Unexpected teething problems: CNGS



Target motorization failure

33

In-situ inspection (April 8-9, 2008)

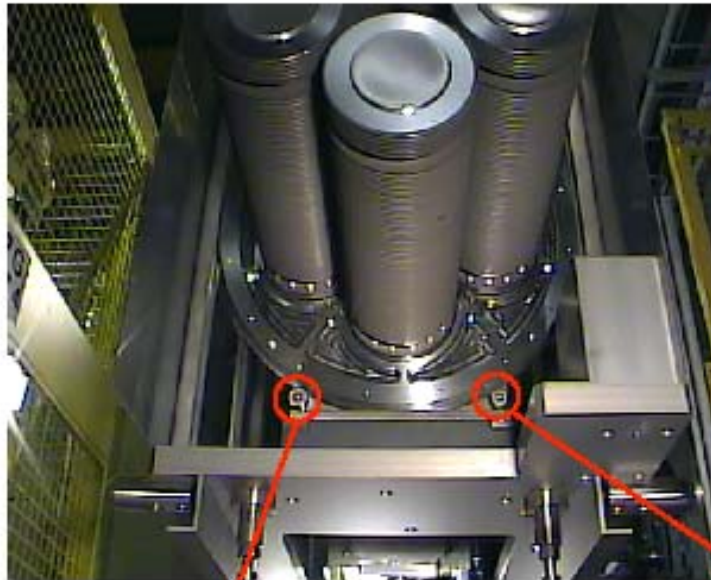

Summary of observations:

- all four ball-bearings have signs of rust
 - 3 turn when the barrel moves but with difficulty
 - 1 doesn't turn at all in one direction (at least at startup)
-
- Discussing again with the supplier we discovered that contrary to the specifications, the pieces delivered were treated with a lubricant (YVAC3) thought to be radiation hard

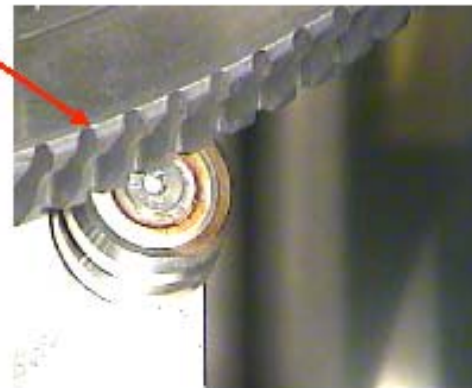
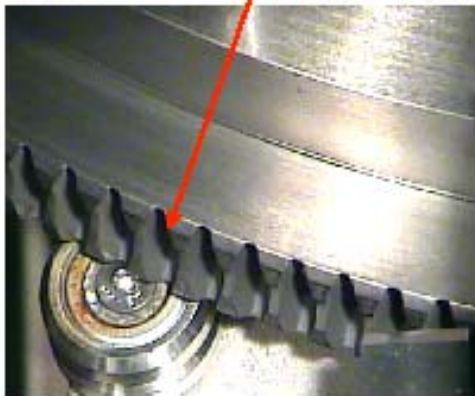

T2K Secondary Beam-line

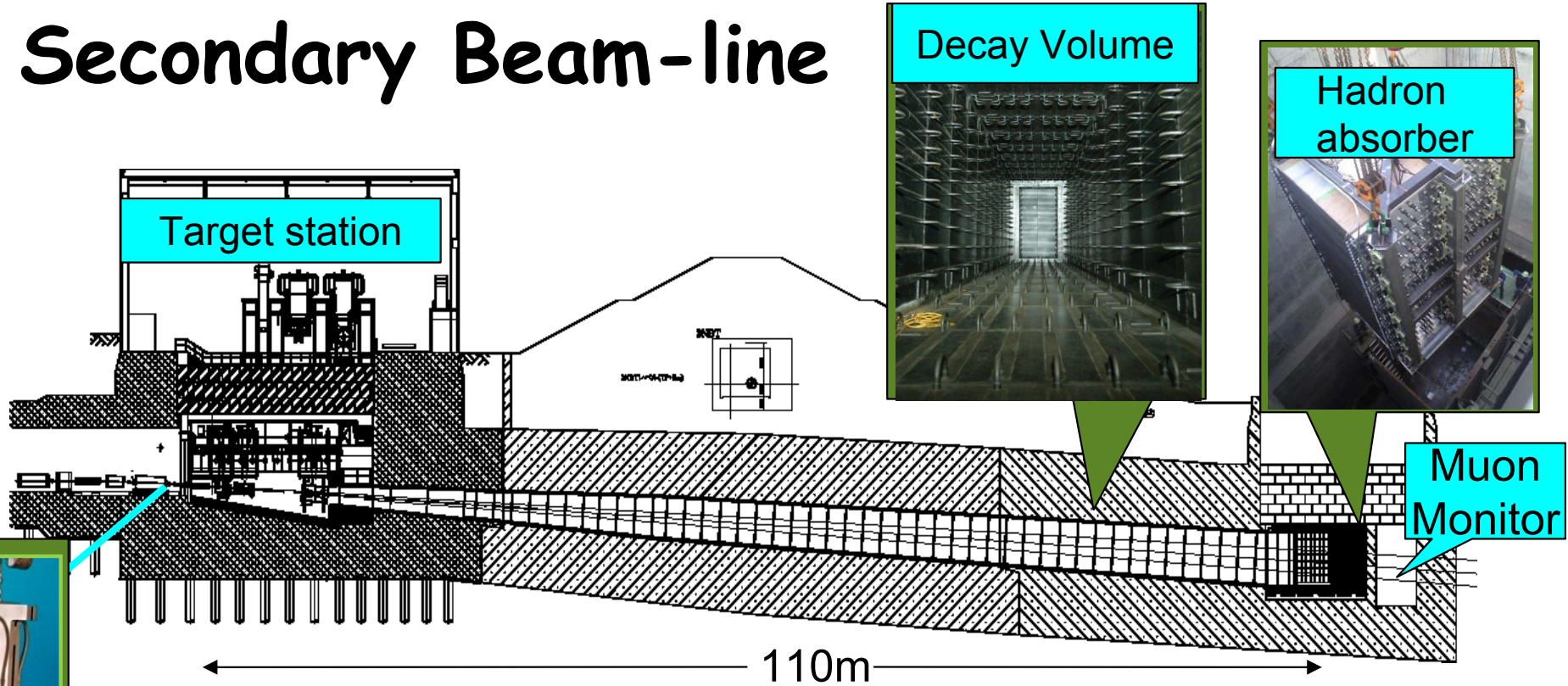

Beam window

T2K Secondary Beam-line

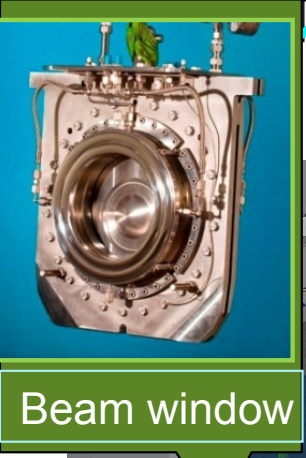
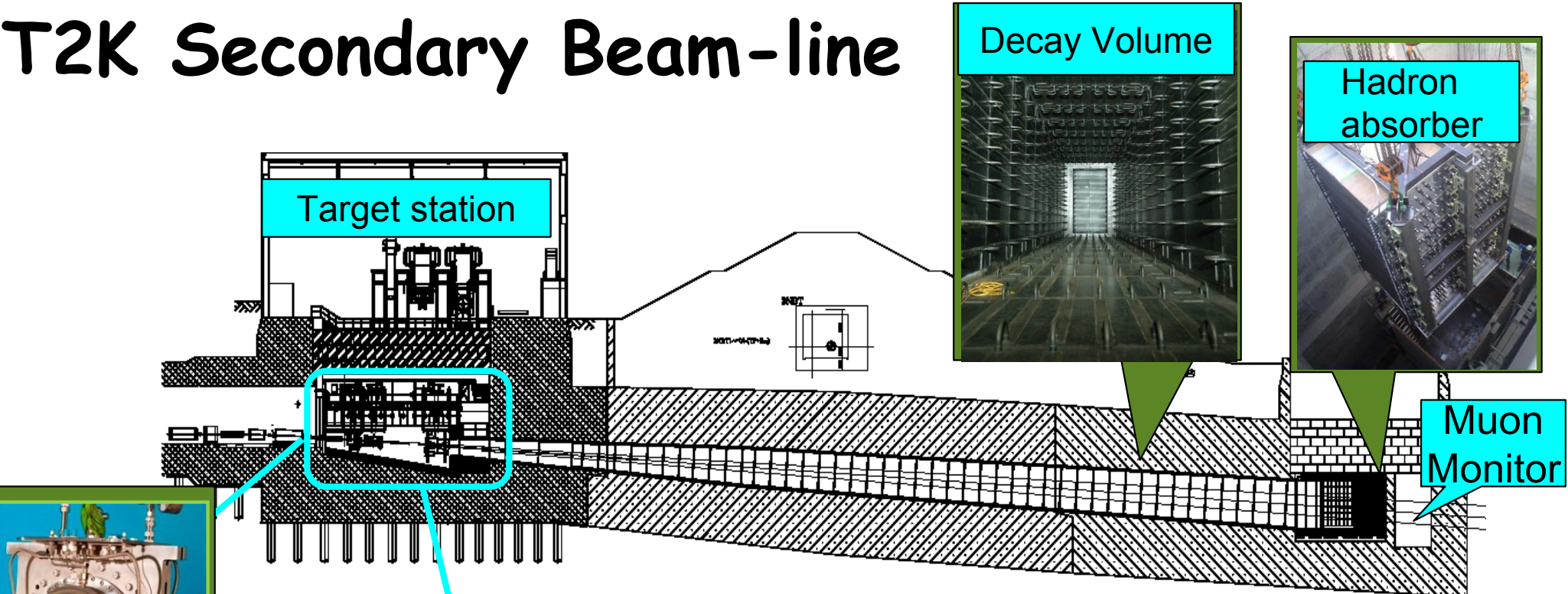

Beam window

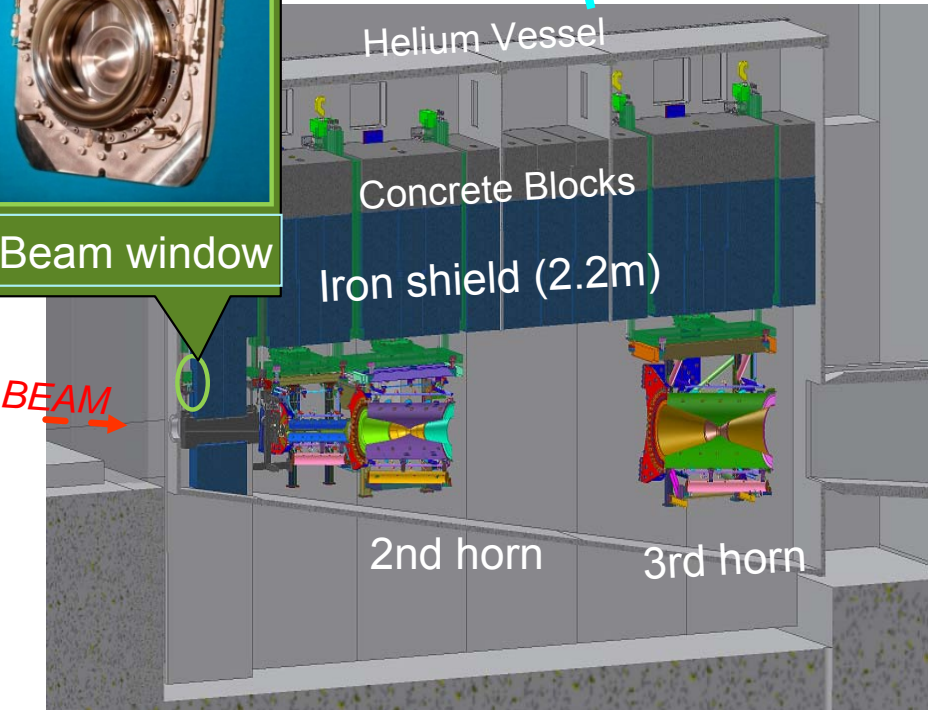

Helium Vessel

Concrete Blocks

Iron shield (2.2m)

2nd horn

3rd horn

T2K Secondary Beam-line

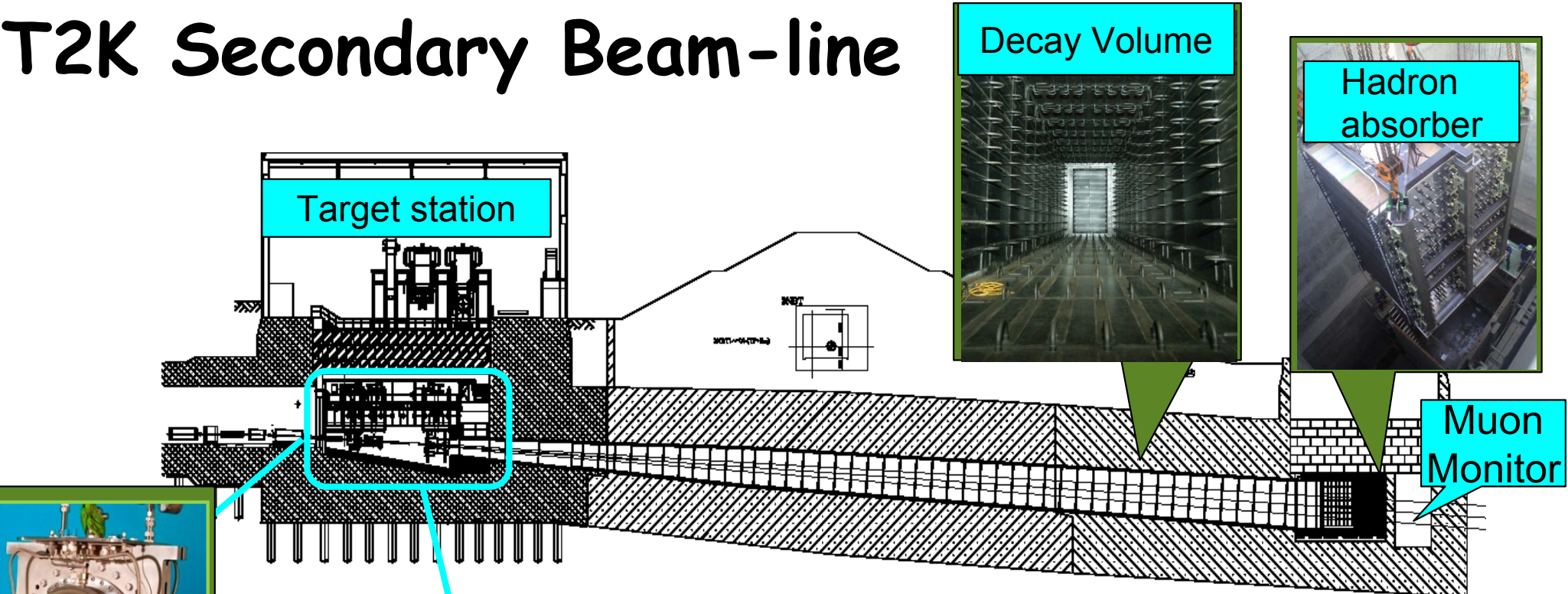

Beam window

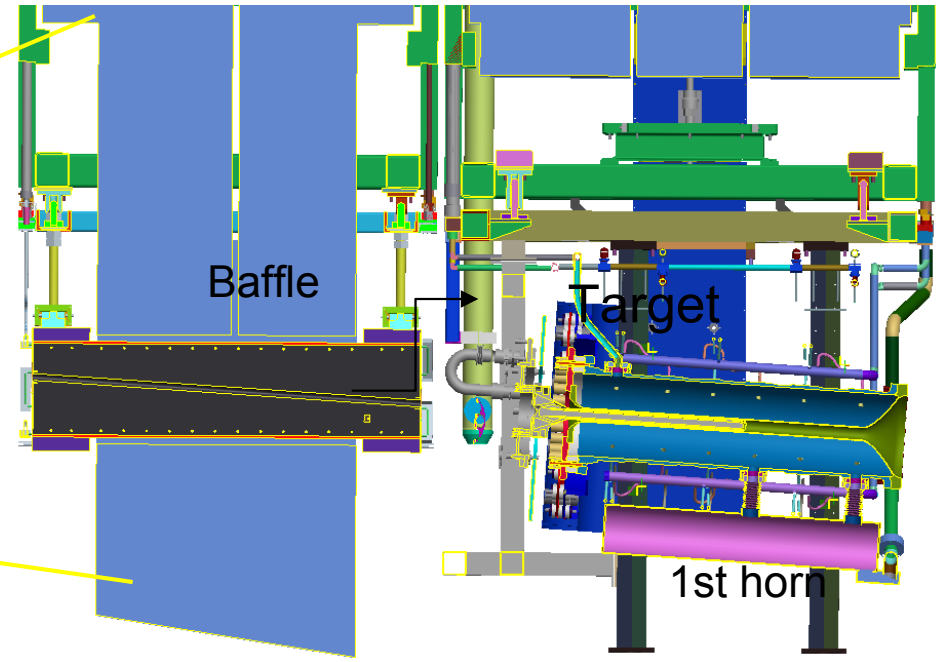
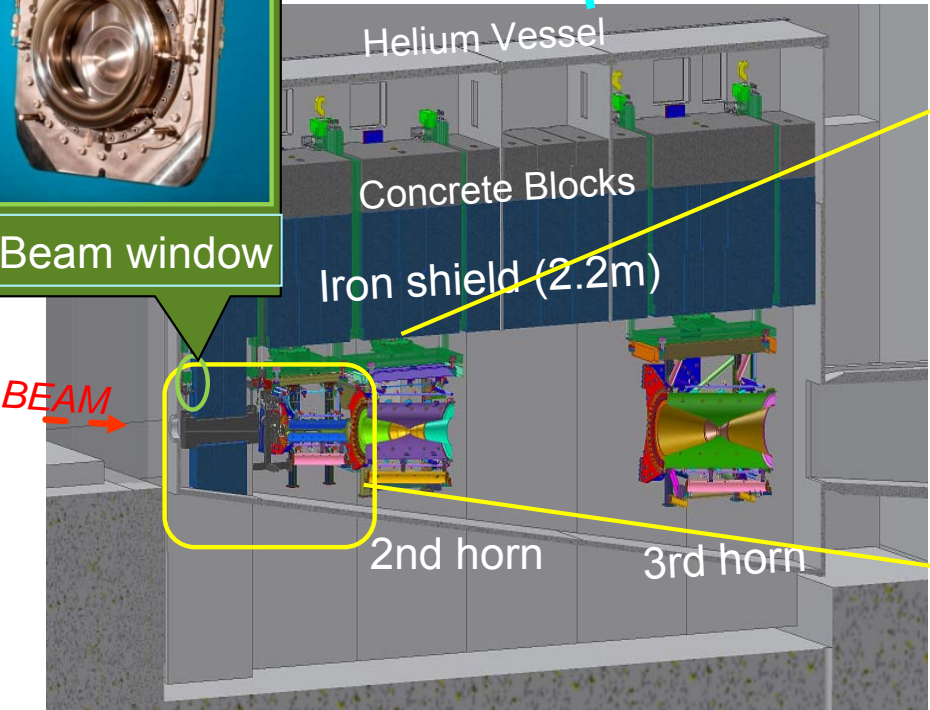

Target Mk 2.0 Design

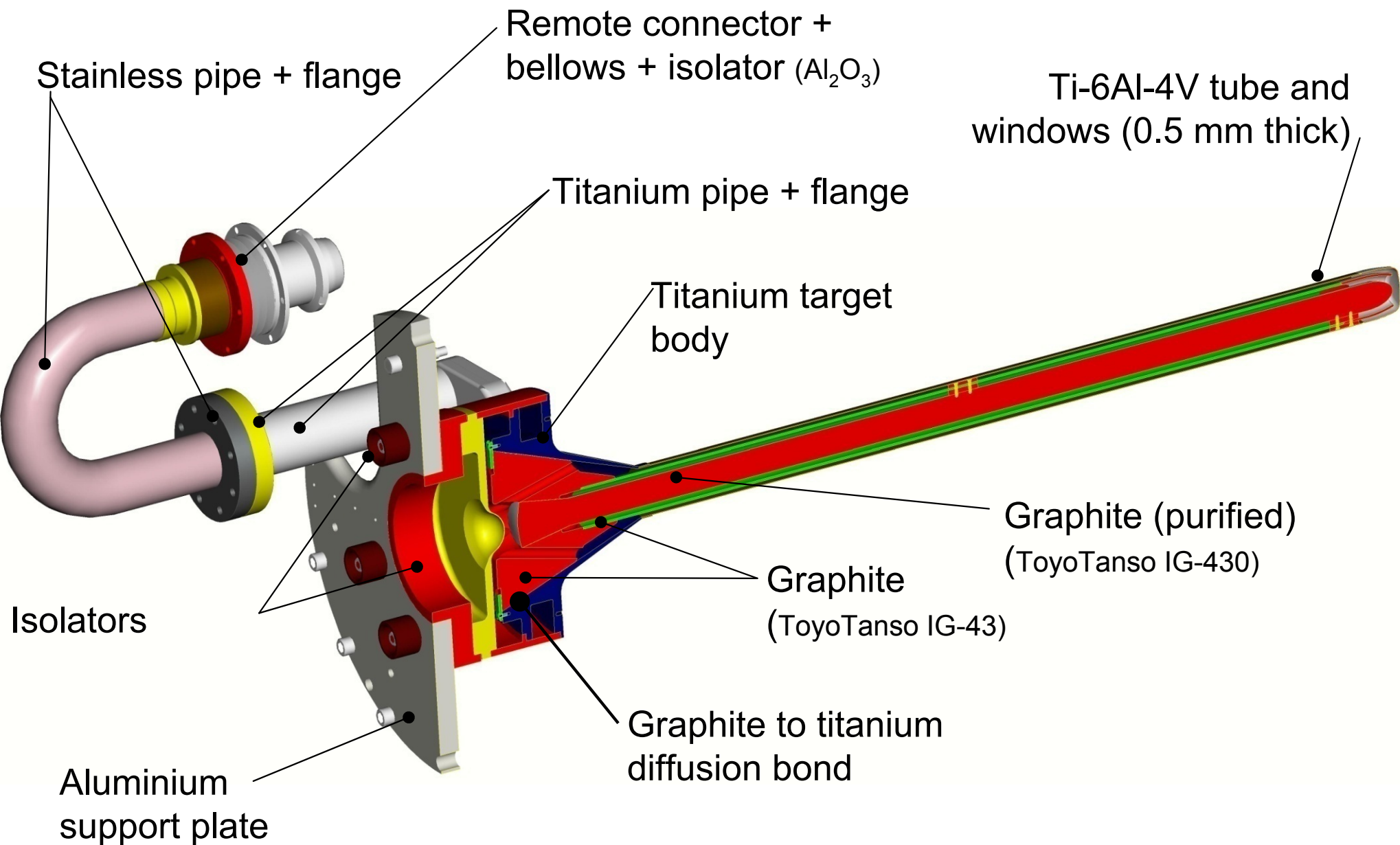

Diffusion Bond + Graphite-Graphite bonding test

IG43 Graphite diffusion bonded into Ti-6Al-4V titanium, Special Techniques Group at UKAEA Culham

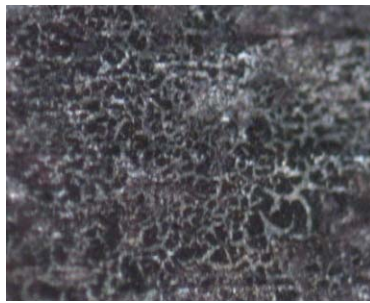
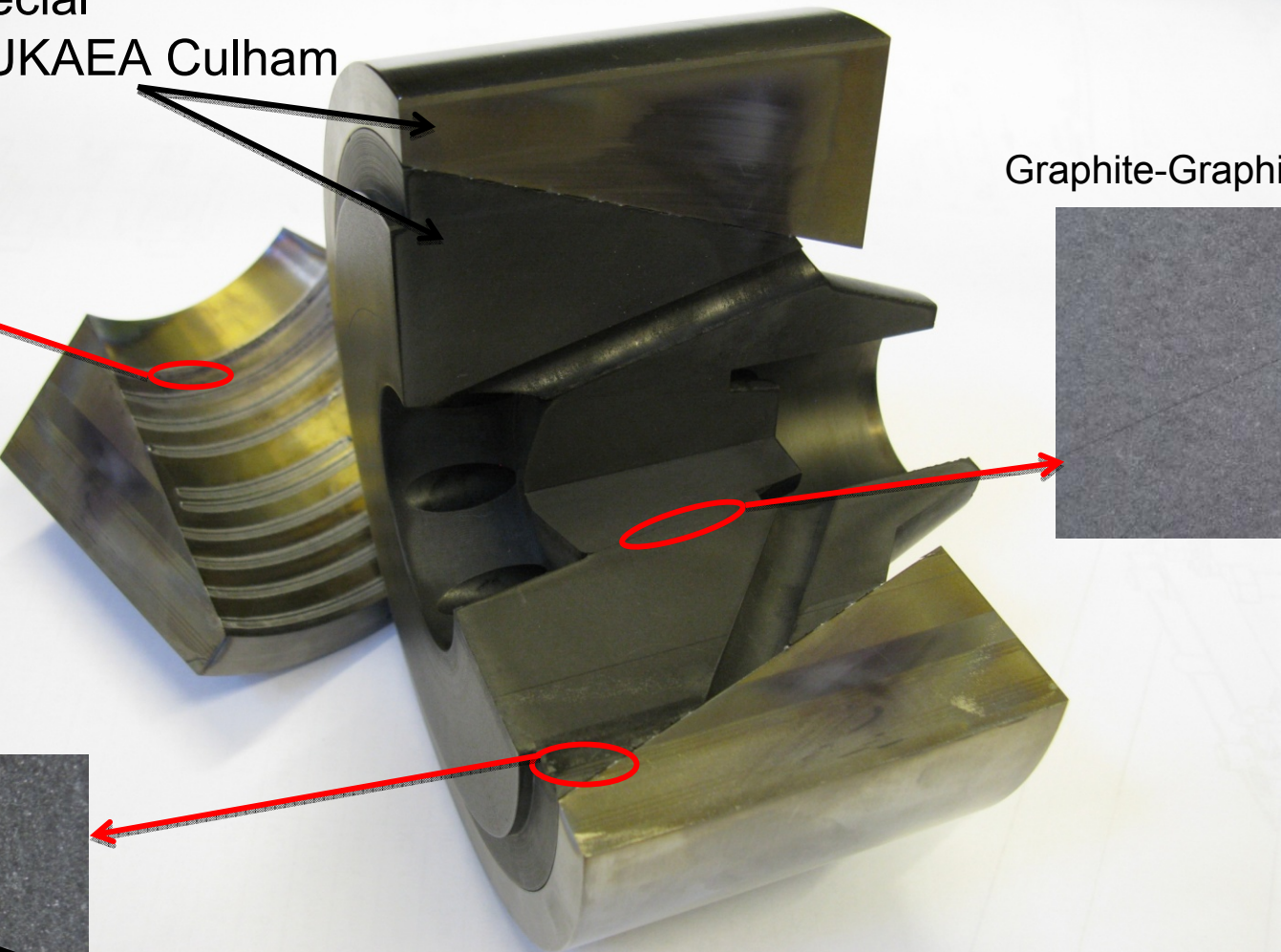

Graphite transfer to Aluminium

Graphite-Graphite bonding

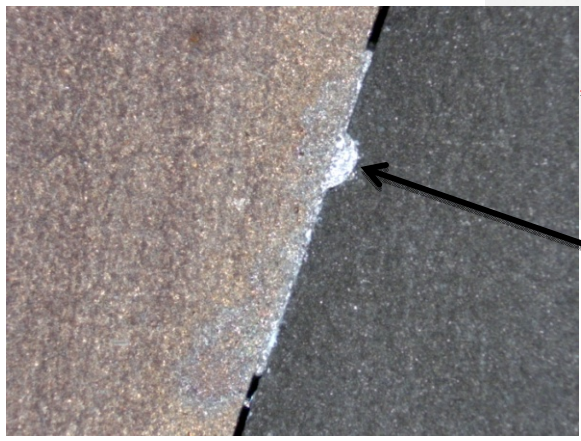

Aluminium intermediate layer, bonding temperature 550°C
Soft aluminium layer reduces residual thermal stresses in the graphite

All graphite components assembled and bonded in one operation

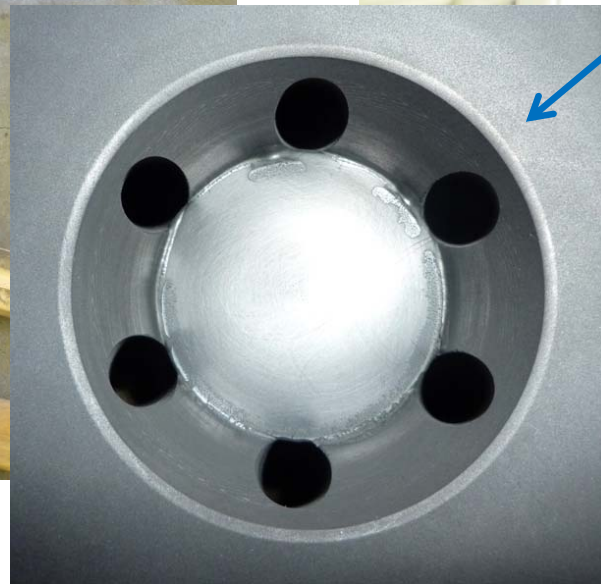
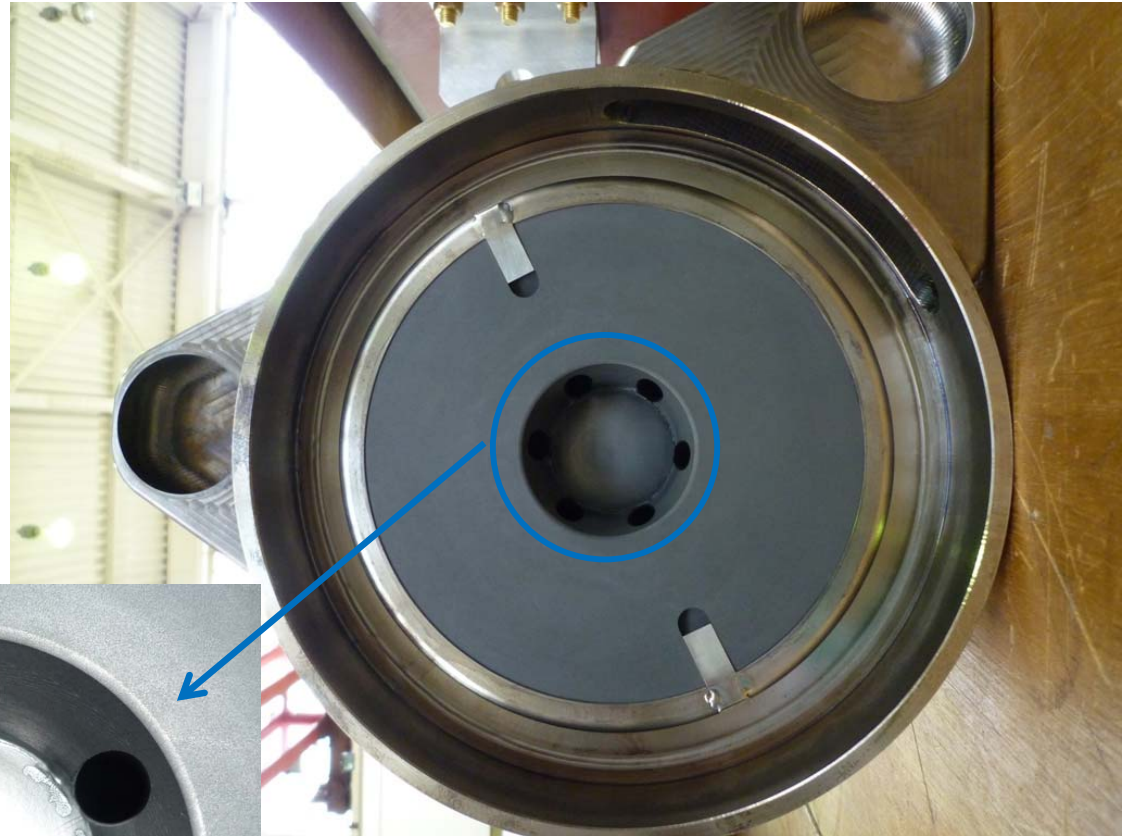



Outer tube

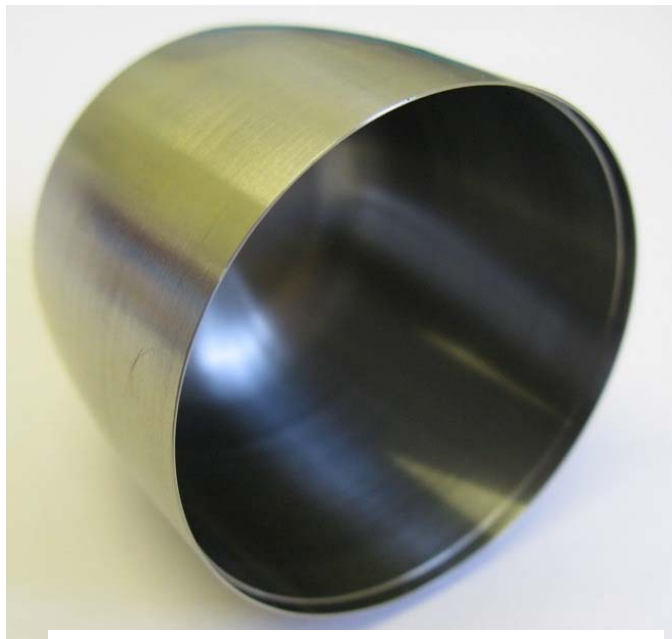

Downstream window

Final titanium components assembled and electron beam welded

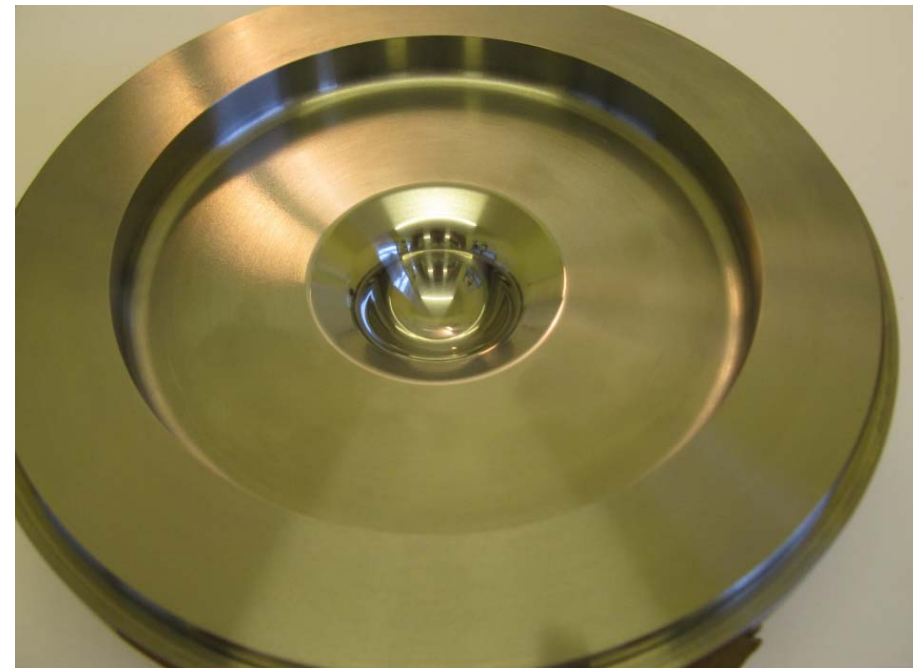
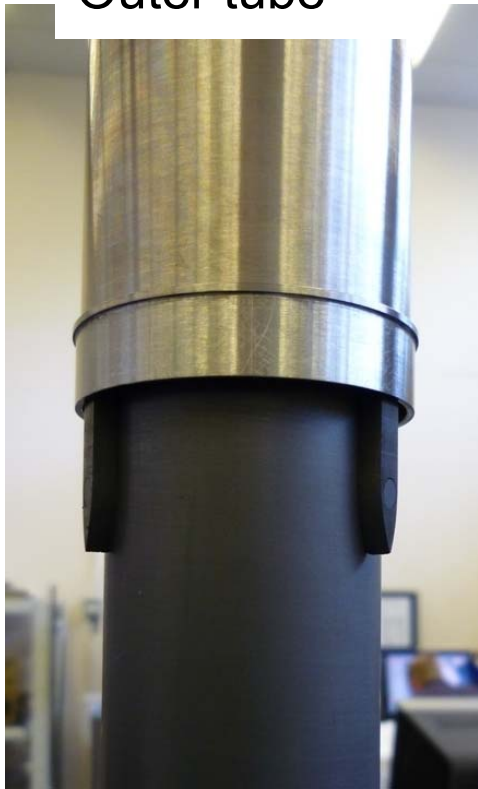

Upstream window

Target Design: Helium cooling path

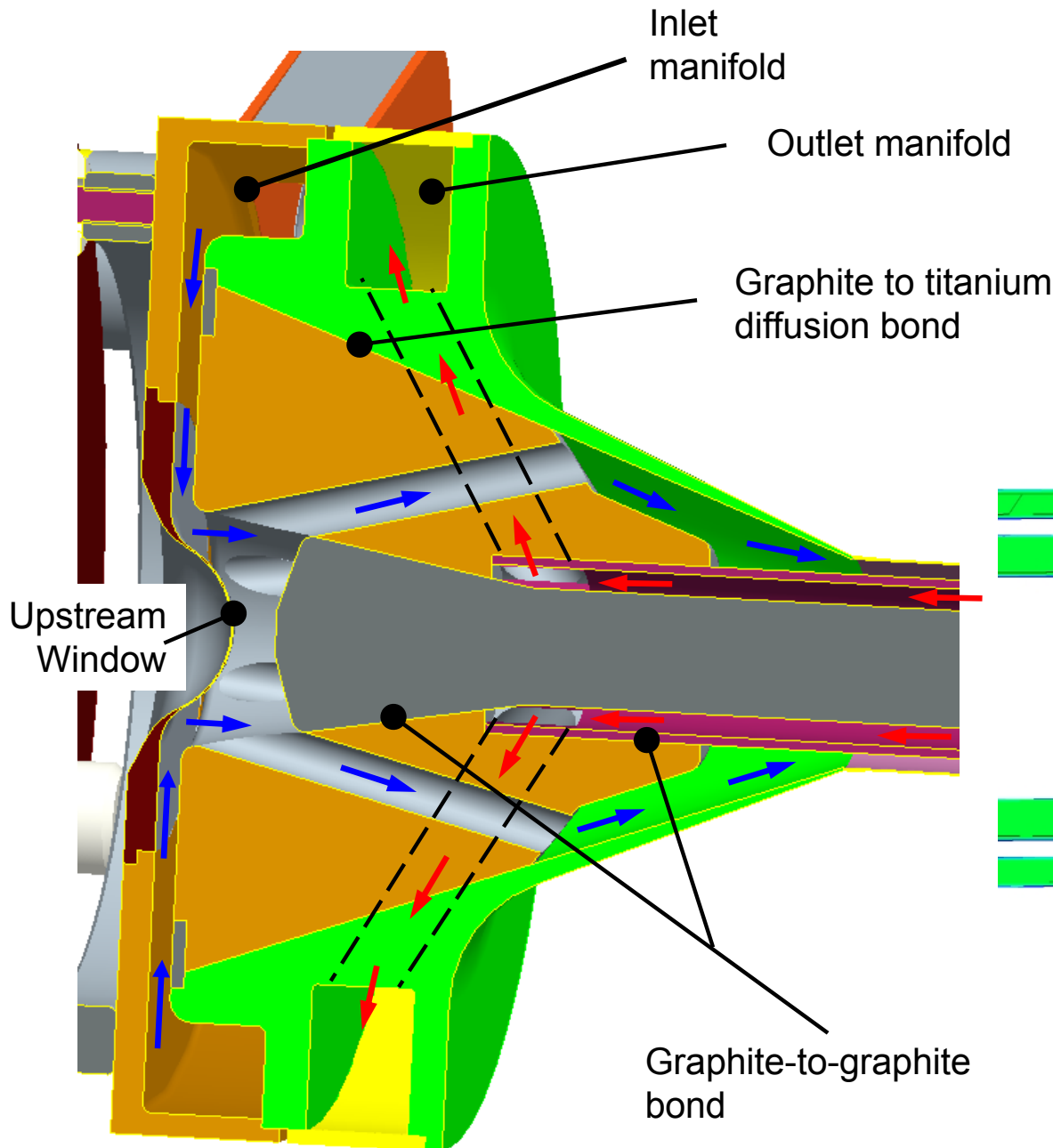

Flow turns 180° at downstream window

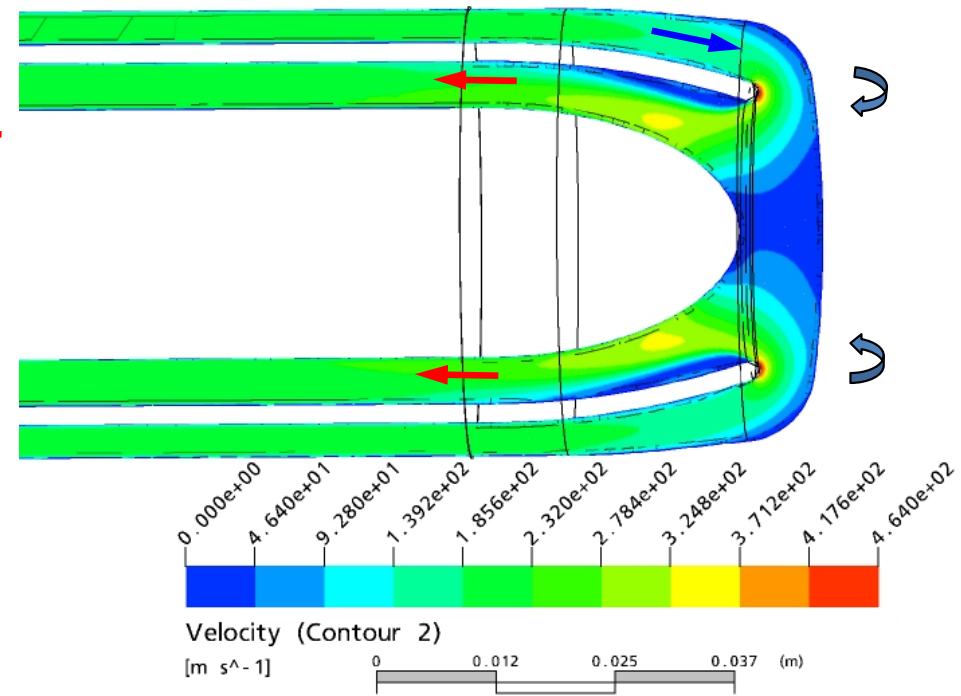

Irradiation effects on Graphite

- Expected radiation damage of the target
 - The approximation formula used by NuMI target group : **0.25dpa/year**
 - MARS simulation : **0.15~0.20 dpa/year**
- Dimension change : shrinkage by **~5mm in length** in 5 years at maximum.
~75μm in radius
- Degradation of thermal conductivity ... **decreased by 97% @ 200 °C**
70~80% @ 400 °C
- Magnitude of the damage strongly depends on the irradiation temperature.
 - It is better to keep the temperature of target around **700 ~ 800 °C**

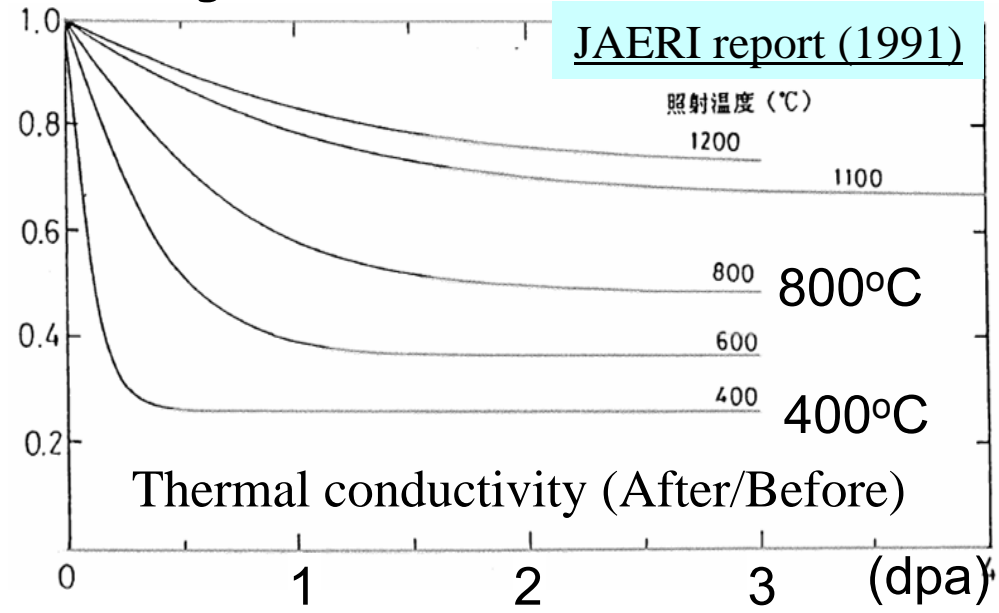
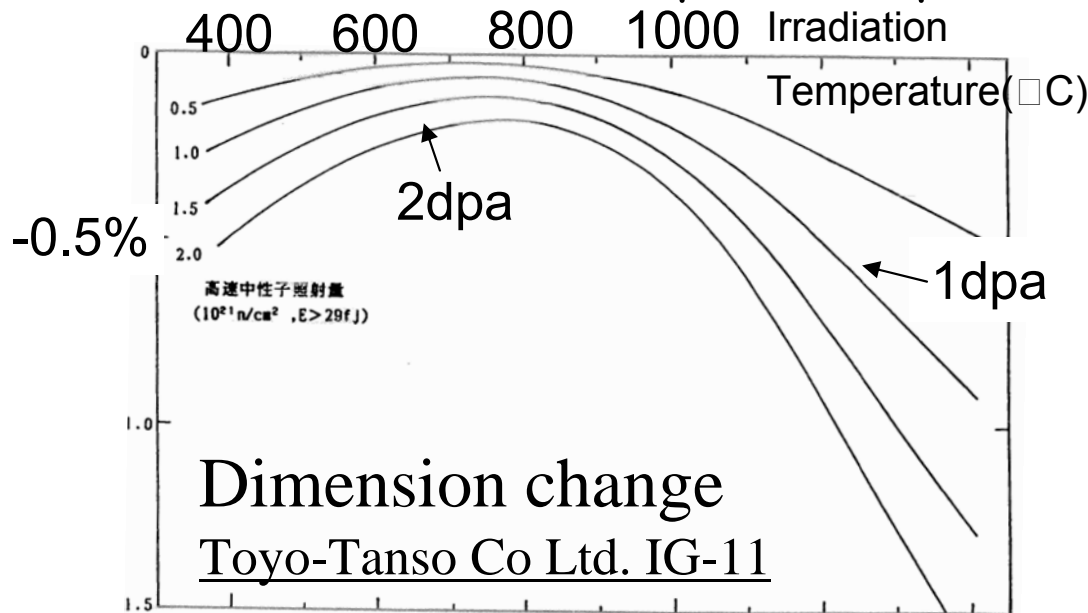

Steady state target temperature

30 GeV, 0.4735Hz, 750 kW beam

Radiation damaged graphite assumed (thermal conductivity 20 [W/m.K] at 1000K- approx 4 times lower than new graphite)

CFX

Maximum temperature = 736°C

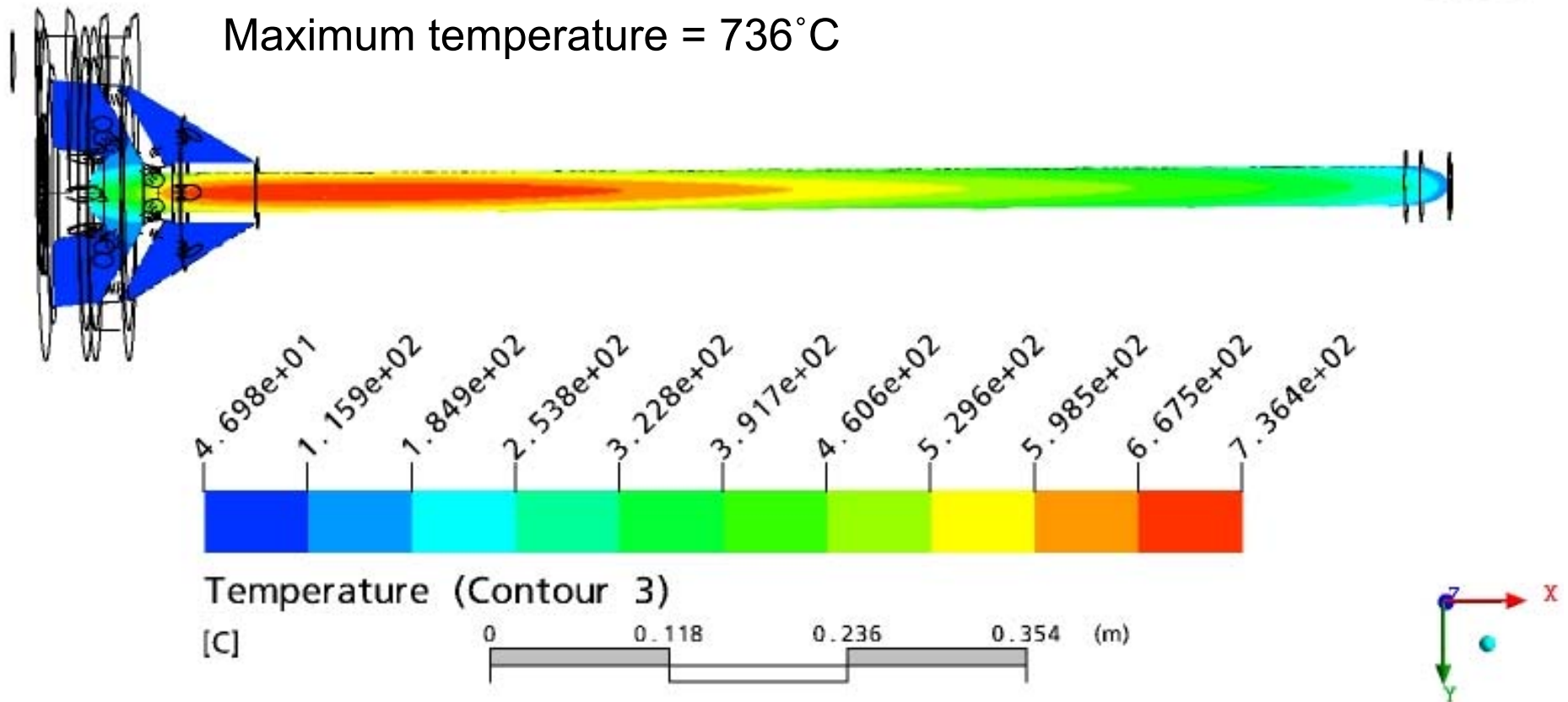

Effect of pulsed beams (III): T2K target

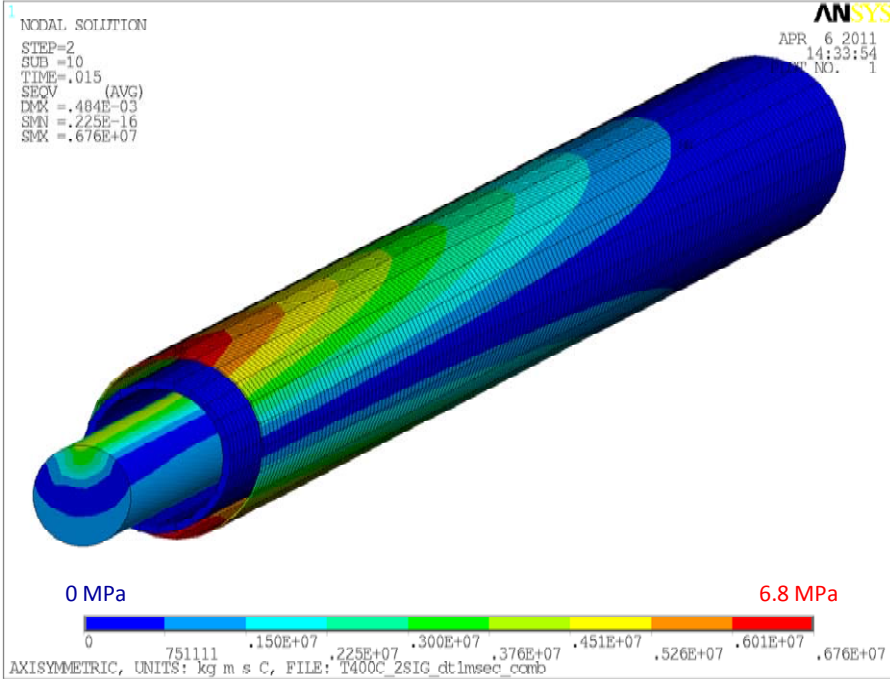

Inertial 'violin modes' in T2K target after single off-centre beam spill

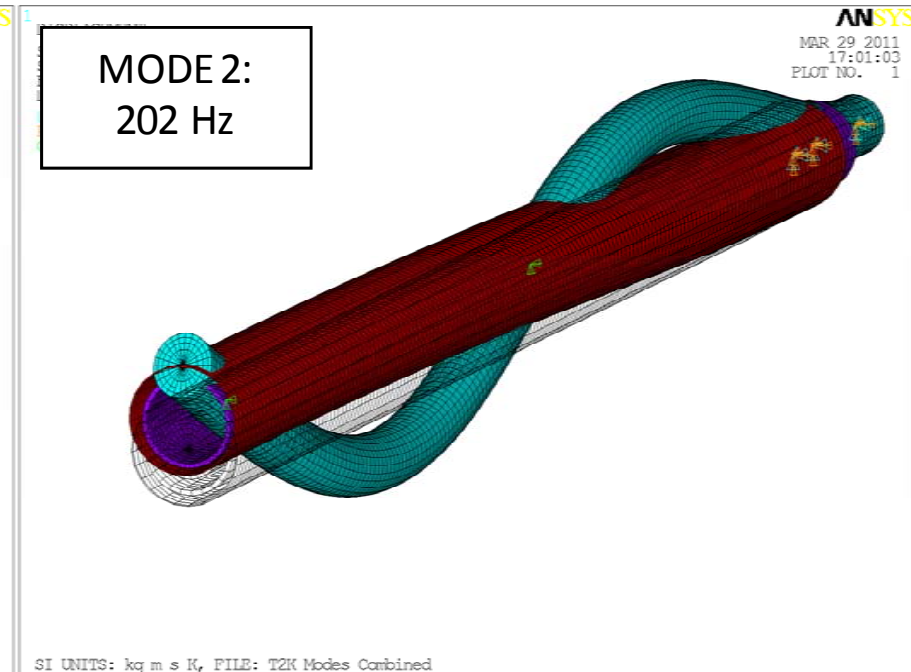
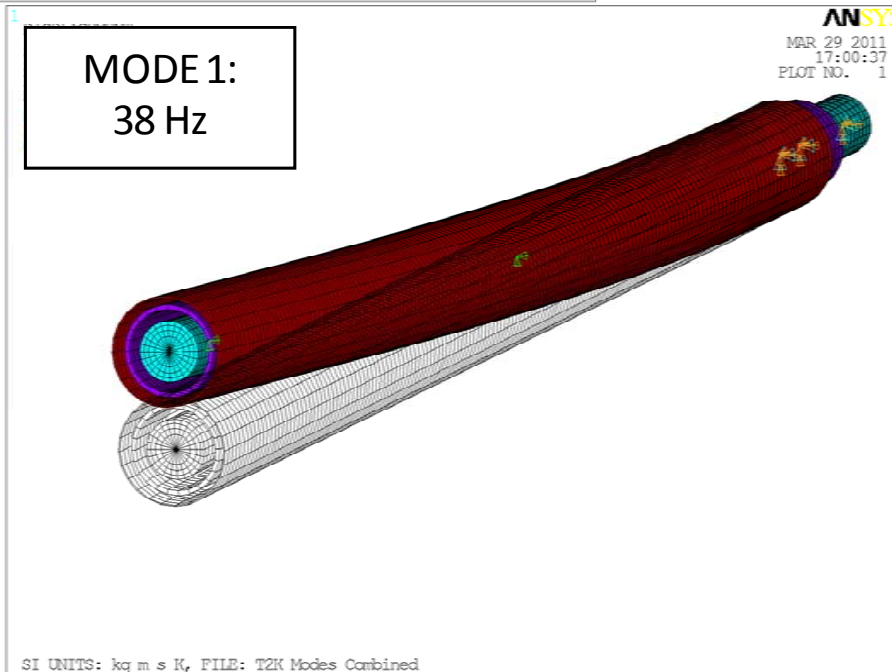

Effect of pulsed beams (III): T2K target

Inertial "Violin Modes" in the T2K Target after a single off-centre beam spill
2-sigma beam offset, $3.3e14$ protons @ 30 GeV
Graphite-IG43 Material Properties @ 400°C, L=900mm, R=13mm

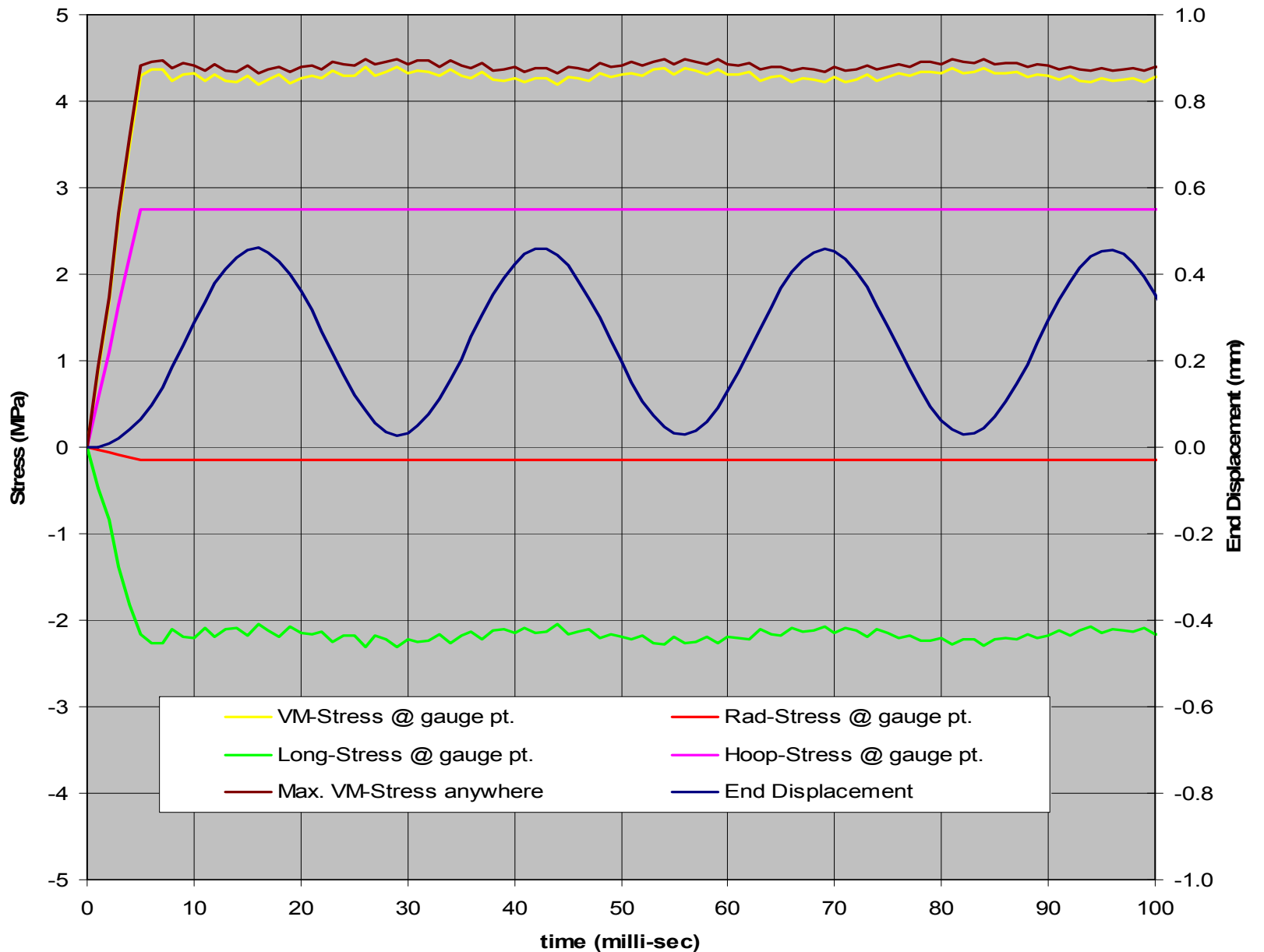

NB Stresses are no higher than for on-centre beam

'Unexpected' problems: T2K...

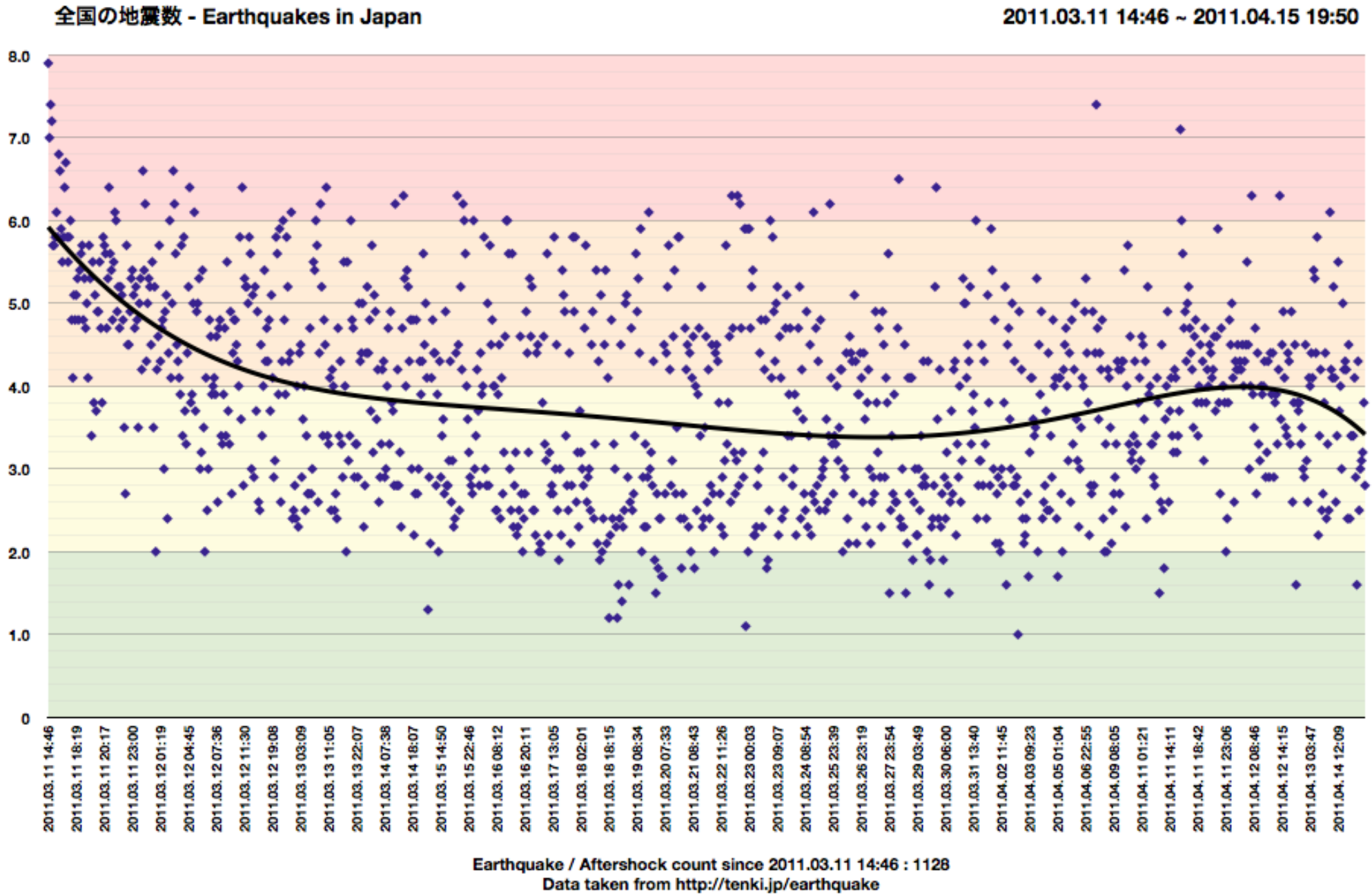

The Akogigaura Club / hotel - the place to stay for JPARC...



- Amazingly, nobody injured on JPARC site
- Tsunami passed by
- JPARC reactors OK
- Much settling around building foundations and resultant damage to ancilliary systems
- No severe damage to facility reported so far

