

# FETS\*-HIPSTER\*\*

\* Front End Test Stand

\*\*High Intensity Proton Source for Testing Effects of Radiation

Chris Densham, Tristan Davenne, Alan Letchford (RAL),  
Juergen Pozimski (Imperial College/RAL),  
Steve Roberts (University of Oxford)  
May 20, 2015

**RaDIATE Collaboration**

Radiation Damage In Accelerator Target Environments





## High brightness H<sup>-</sup> ion source

- 4 kW peak-power arc discharge
- 60 mA, 0.25 π mm mrad beam
- 2 ms, 50 Hz pulsed operation

## Radio Frequency Quadrupole

- Four-vane, 324 MHz, 3 MeV
- 4 metre bolted construction
- High power efficiency

## Diagnostics

- Non-interceptive
- Well distributed
- Laser-based

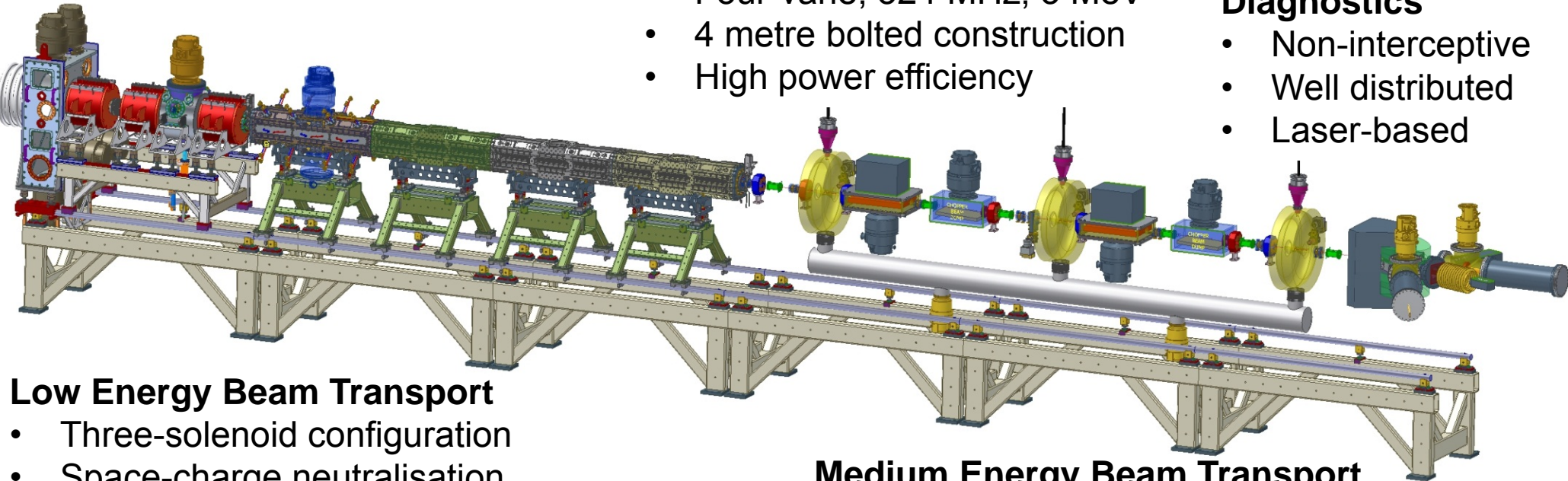

## Low Energy Beam Transport

- Three-solenoid configuration
- Space-charge neutralisation
- 5600 Ls<sup>-1</sup> total pumping speed

## Medium Energy Beam Transport

- Re-buncher cavities and EM quads
- Novel 'fast-slow' perfect chopping
- Low emittance growth

# Front End Test Stand (FETS)

- FETS is an accelerator test facility at RAL
- HIPSTER is a potential application as a materials irradiation facility

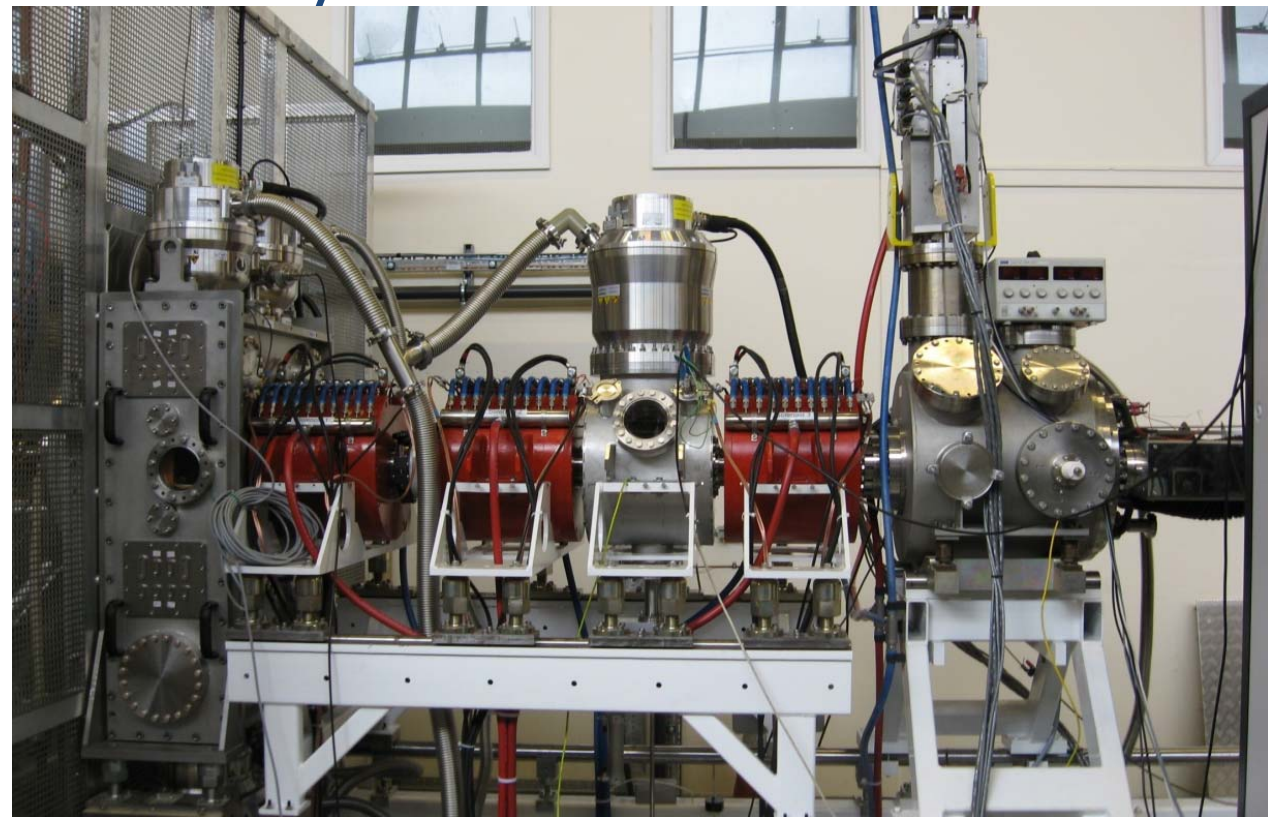

FETS  
Low Energy Beam  
Transport (LEBT)

**RaDIATE Collaboration**

Radiation Damage In Accelerator Target Environments

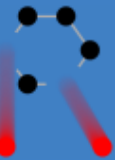

# Front End Test Stand (FETS)

- FETS is an accelerator test facility at RAL
- HIPSTER is a potential application as a materials irradiation facility

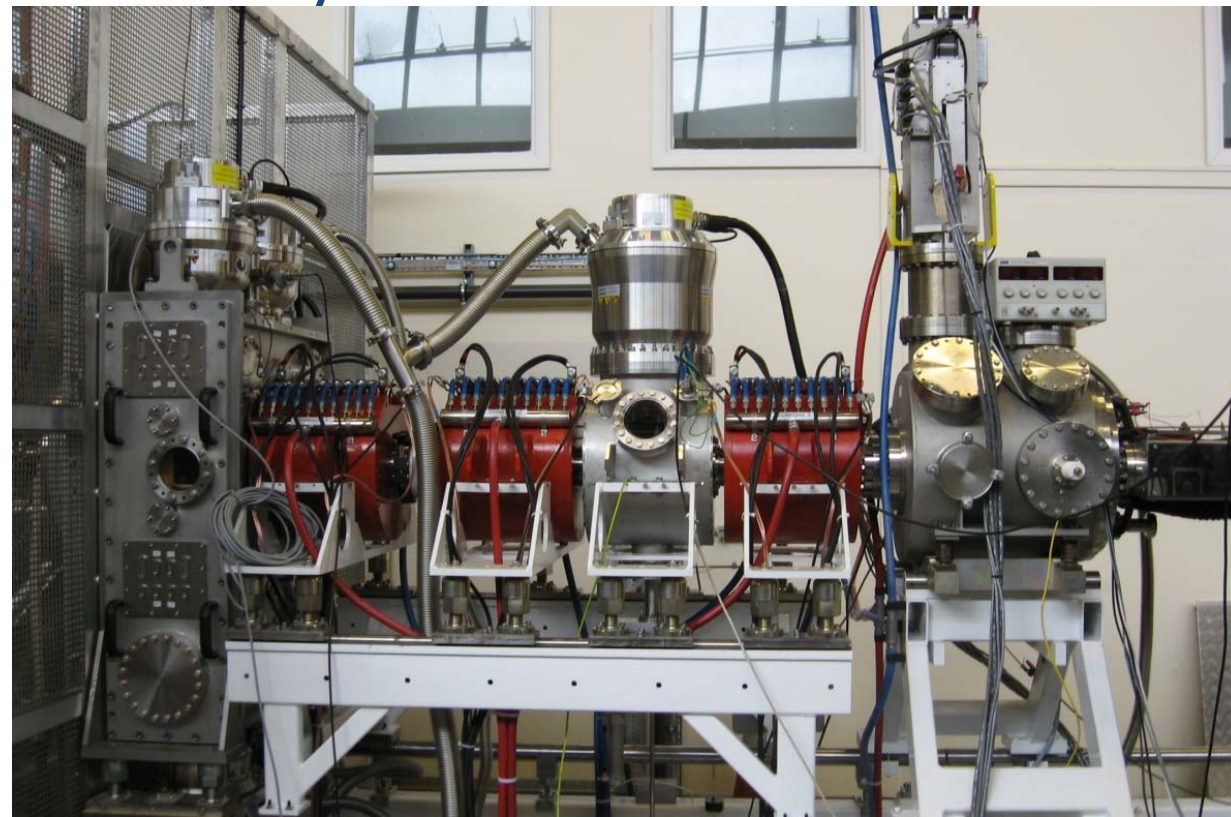

FETS  
Low Energy Beam  
Transport (LEBT)

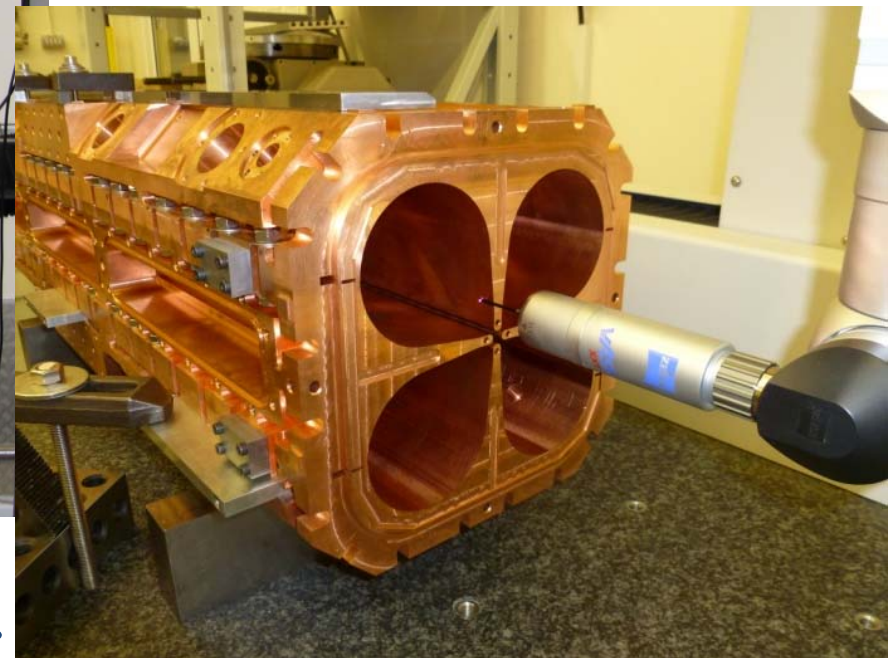

RFQ

**RaDIATE Collaboration**

Radiation Damage In Accelerator Target Environments



# FETS-HIPSTER parameters

- Proton beam energy = 3 MeV
- Beam sigma = 21.2 mm i.e. FWHM = 50mm
- Beam Pulse length = 2 ms
- Beam Frequency = 50 Hz
- Time averaged beam current = 6 mA
- Current during beam pulse = 60 mA
- Candidate materials for irradiation testing: Be, C, Ti, Steels, W



# FETS Future and long term plans

It is the aspiration of the FETS team to develop a 5-10 year plan for the future expansion and exploitation of FETS.

Our bid for continuation contains some element of forward look as well as the primary goal of completing the current phase.

FETS continues discussions with the neutron, medical and fusion materials communities as well as active participation in the Proton Accelerator Alliance.

## Application R&D

(partly) external funded

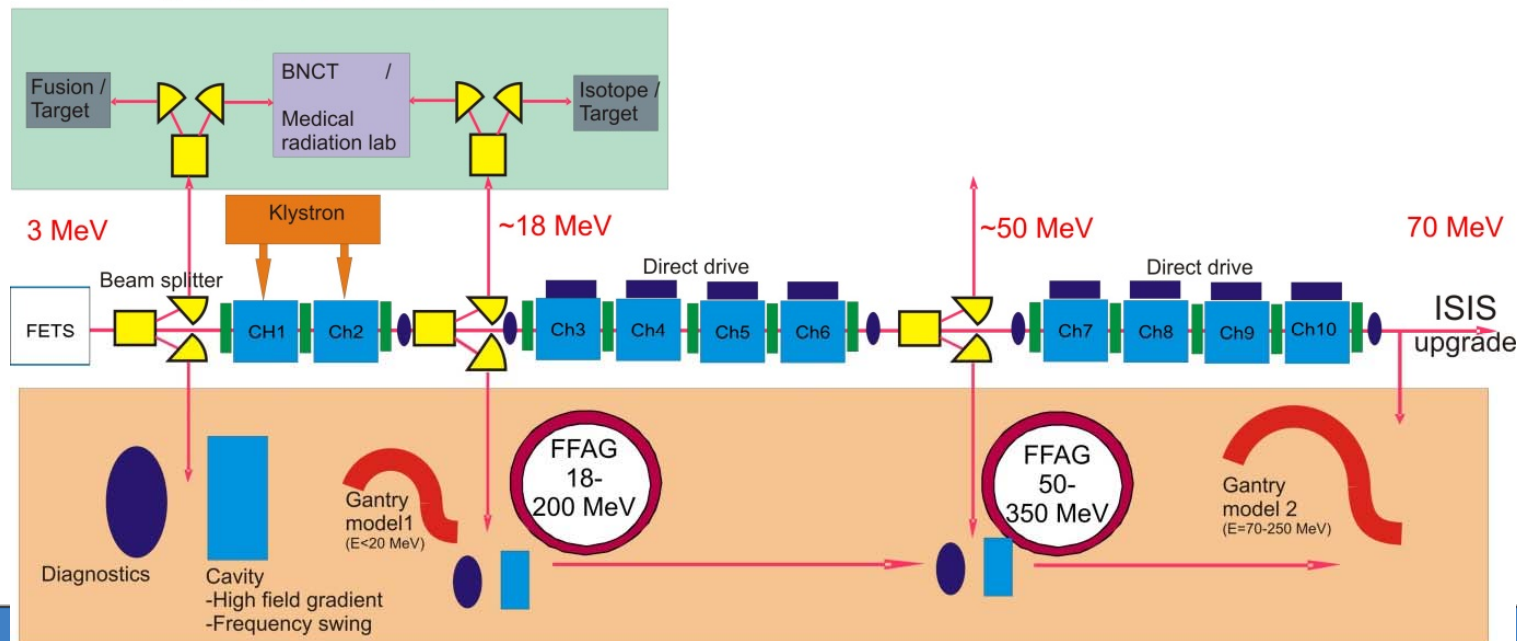

## Accelerator R&D

(Proton Accelerator Alliance)



# FETS-HIPSTER

- Extension of the Front End Test Stand (FETS) would provide a high-intensity (6 mA, 3 MeV) materials irradiation facility
- HIPSTER would be capable of studying:
  - irradiation induced microstructural changes and mechanical properties
  - 'deep' (~25 micron), near-uniform radiation damage to moderate levels within reasonable timescales (up to ~100 dpa per annum)
  - High heat flux source (ref fusion divertor)
- The downside(?): pulsed beam
  - Good for accelerator materials testing
  - Potential limitation for fusion/fission materials testing



# HIPSTER outline

- Beamline extension to transport beam from FETS -> HIPSTER
- Material samples could be located in prototypic environments within a shielded target station
- Remote handling facilities would enable transfer of material samples into shielded containers
- Activated samples would be supplied to collaborating institutes for post-irradiation examination, for example the NNUF irradiated materials test facility at CCFE (Culham Centre for Fusion Energy)
- Possible beam sharing with other applications





# Proposal submitted to UK National Nuclear Users Facility

High-Flux Proton Irradiation Facility

## Proforma for additional equipment for the National Nuclear Users Facility.

### **FETS-HIPSTER- A High-Flux Proton Irradiation Facility**

**Names:** Steve Roberts (Oxford/CCFE), Chris Densham (RAL), Alan Letchford (RAL), Juergen Pozimski (Imperial College/RAL)

**Institution:** University of Oxford, Department of Materials; STFC Rutherford Appleton Lab

**High Intensity Proton Source for Testing Effects of Radiation (HIPSTER).** Extension of the Front End Test Stand (FETS) proton source already funded and currently being commissioned at Rutherford Appleton Laboratory to provide a world-unique high-intensity (6mA, 3MeV / 18MeV) materials irradiation facility. FETS-HIPSTER would be capable of delivering deep (~25 micron), near-uniform radiation damage to moderate levels within reasonable timescales (up to ~100 dpa per annum) , enabling studies of irradiation induced microstructural changes and mechanical properties including hardening, embrittlement, creep, fatigue and stress-corrosion cracking, and thermal property changes such as thermal conductivity. The facility would also have applications in verifying and developing nucleonics codes and in thermal shock loading tests.



# HIPSTER c.f. other proton facilities

	Energy	Proton current	Target area	T-range	Readiness	Notes
<b>FETS-HIPSTER</b>	<b>3 MeV fixed: upgradable to 15-18 MeV</b>	<b>6mA average (60mA pulses, 10% duty cycle)</b>	<b>undecided, but up to 300mm diameter</b>	<b>300 – 1000C likely</b>	<b>Accelerator being commissioned, target area to be designed &amp; commissioned</b>	<b>protons only.</b>
DCF	variable, <1 MeV – 10 MeV	0.1mA	~5cm diameter	Under development	Single beam now, dual beam in late 2015	part of dual – beam facility. Can deliver any ion at micro-Amp current
Birmingham cyclotron	11-39 MeV	60 $\mu$ A	Several cm?		Under construction	Max run time 6-10 hours – shared with isotope production.
<b>Birmingham dynamitron</b>	<b>Up to 3MeV</b>	<b>1 mA</b>	<b>Several cm?</b>		<b>Under construction</b>	<b>Long run times?</b>
UK IBC, Surrey	up to 2 MeV	3 $\mu$ A ( $2 \times 10^{13}$ H/s) / 30 $\mu$ A	Up to ~40cm diameter	Up to 900C	Operational	
JaNNUS	up to 4 MeV (typically 2.5MeV on <i>Yvette</i> for H <sup>+</sup> )	40 $\mu$ A ( $2.5 \times 10^{14}$ ions/s)	~2.5cm diameter	up to 800C	Operational	Part of triple – beam facility.
HZDR	up to 6 MeV	0.001 - 100 $\mu$ A	Up to 10cm diameter?	up to 800C	Operational	
IMBL, Michigan	400 kV – 3 MeV	1 nA – 50 $\mu$ A	~5cm diameter		late 2014.	Part of triple – beam facility.
<b>MIAMI Huddersfield</b>	<b>2- 100 kV</b>	<b><math>10^{10} - 10^{14}</math> ions/cm<sup>2</sup>/s</b>	<b>TEM foil</b>		<b>Operational</b>	<b>In-situ irradiation TEM</b>

# HIPSTER potential programme

- Protons as surrogates for reactor neutrons
  - Strong theoretical and experimental underpinning for required temperatures to generate required defect types, densities, hardening, precipitation, segregation...
  - 3 MeV protons can generate radiation damage at end-of-life dpa levels for fission reactors
  - Deep enough penetration (~30 microns) to access 'bulk' mechanical behaviour:
    - hardening, embrittlement, creep, stress-corrosion cracking, and thermal property changes such as thermal conductivity, Environmentally Assisted Cracking
- Nuclear reaction/cross section data
  - For secondary protons generated by fusion
  - Useful for medical physics
- Upgrade to 15-20 MeV attractive to mimic fusion neutrons



# Summary of HIPSTER Simulations

Target side length cm	Target area cm <sup>2</sup>	Power density W/cm <sup>2</sup>	Dpa/s			days/dpa			Max temperature °C			Temperature Fluctuation per pulse		
			Fe	W	Be	Fe	W	Be	Fe	W	Be	Fe	W	Be
10	100	100	1.33E-05	2.37E-05	1.22E-06	0.07	0.49	9.49	86	75	69	46	42	33
20	400	45	3.32E-06	5.92E-06	3.05E-07	3.40	1.96	37.97	39	35	33	11.5	10.6	8.2
50	2500	7.2	5.32E-07	9.47E-07	4.83E-08	21.76	12.23	237.3	25	24	24	1.8	1.6	1.3
100	1.00E+04	1.8	1.33E-07	2.37E-07	1.22E-08	87.04	48.91	949.19	23	23	23	0.5	0.4	0.3

A wide range of target area (beam spot size) have been considered.

SRIM calculations highlight that large dpa values are achievable even with the most blown up beam considered

The larger the beam the easier the thermal management issues are to deal with (but lower damage rate).

With a beam area of 2500 cm<sup>2</sup> the required cooling heat flux is easily manageable at 0.07MW/m<sup>2</sup>, the predicted sample temperature fluctuation is less than 2K and yet 20 dpa/fpy in Tungsten is still possible.

**RaDIATE Collaboration**

Radiation Damage In Accelerator Target Environments



# Heat Flux

For the range of beam size considered the required heat flux would be a maximum of  $1.8\text{MW/m}^2$ , this is below the heat flux achieved in the ISIS Neutron target TS1 at RAL

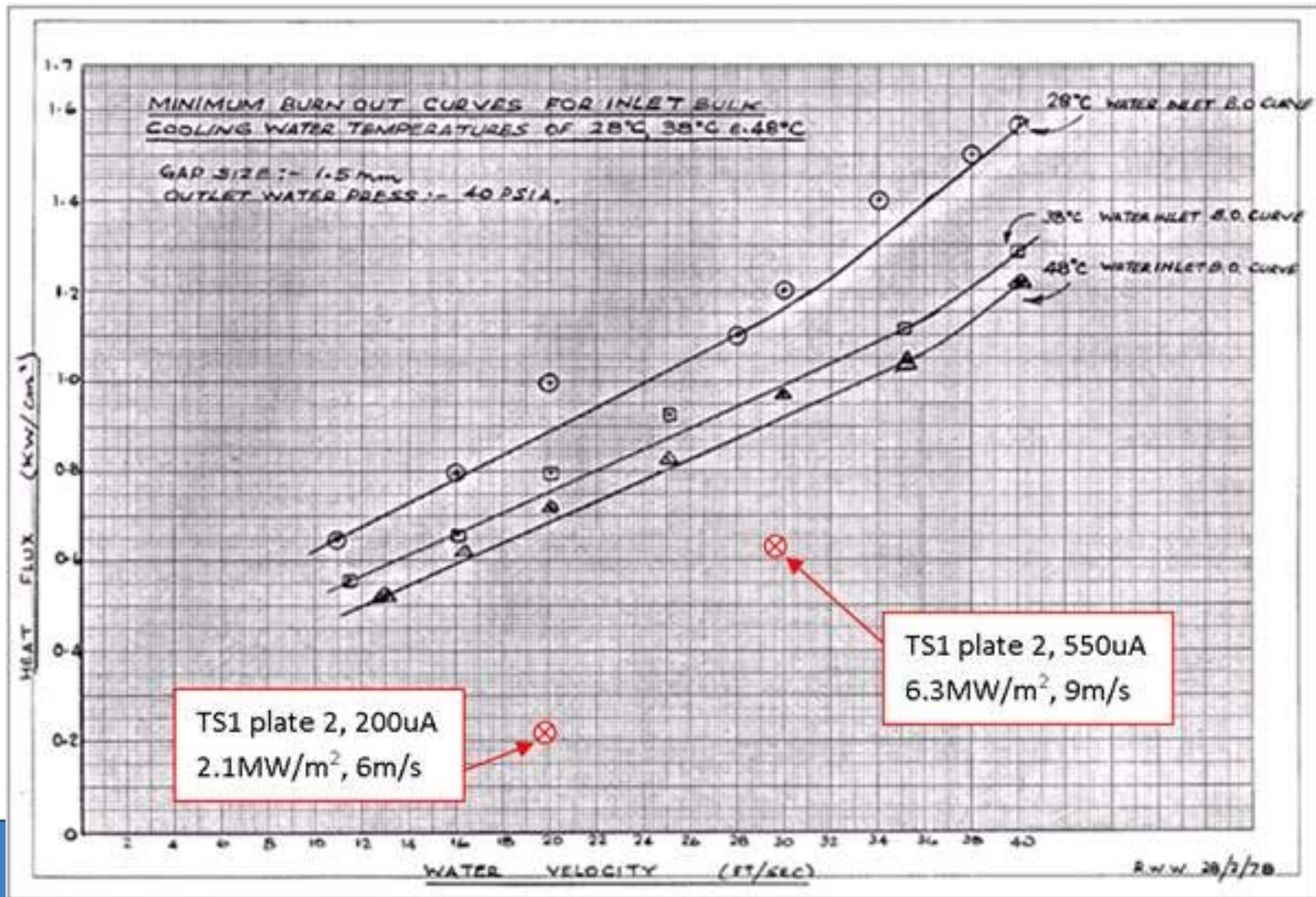

# Example of energy deposition

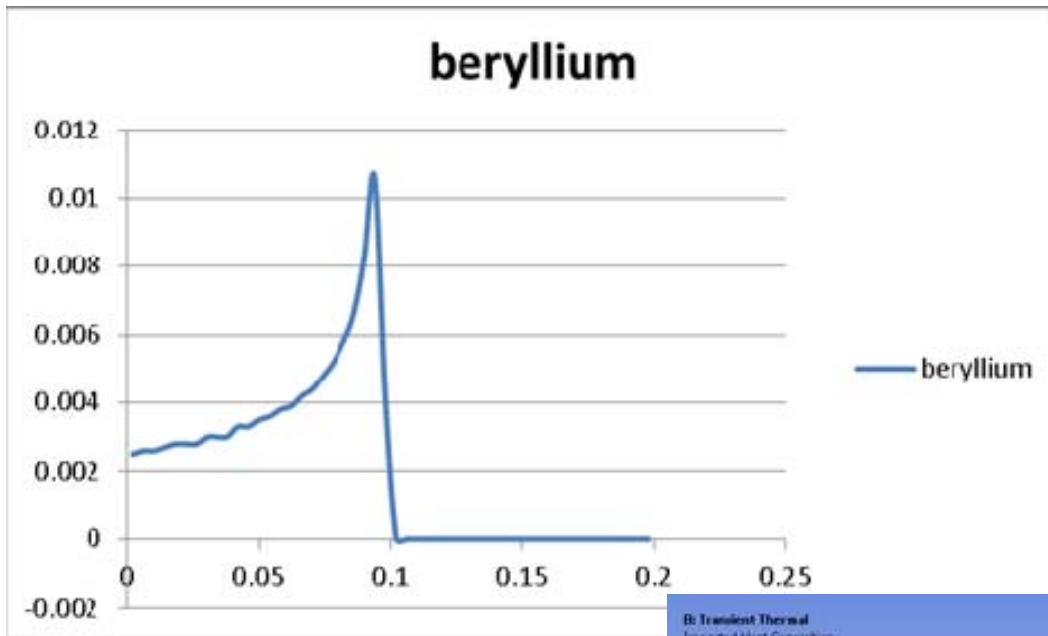

beam stopped within 0.1mm in a beryllium sample

FLUKA Material	Beam stopping distance [mm]
Ti	0.06
W	0.03
C	0.08
Be	0.1

B: Transient Thermal  
Imported Heat Generation  
Unit: W/m²  
30/07/2014 14:18

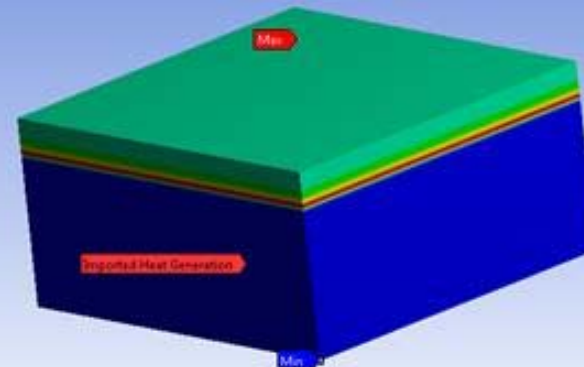
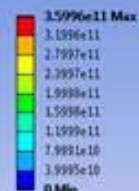

ANSYS  
R15.0



# Thermal Management

Consider a 0.5mm thick 1cm x1cm irradiation sample attached to a water cooled aluminium back plate.

Significant pulse power density results in unsteady sample temperature with peak temperature and fluctuation depending on the sample material.

[Click on image to see video of simulation](#)

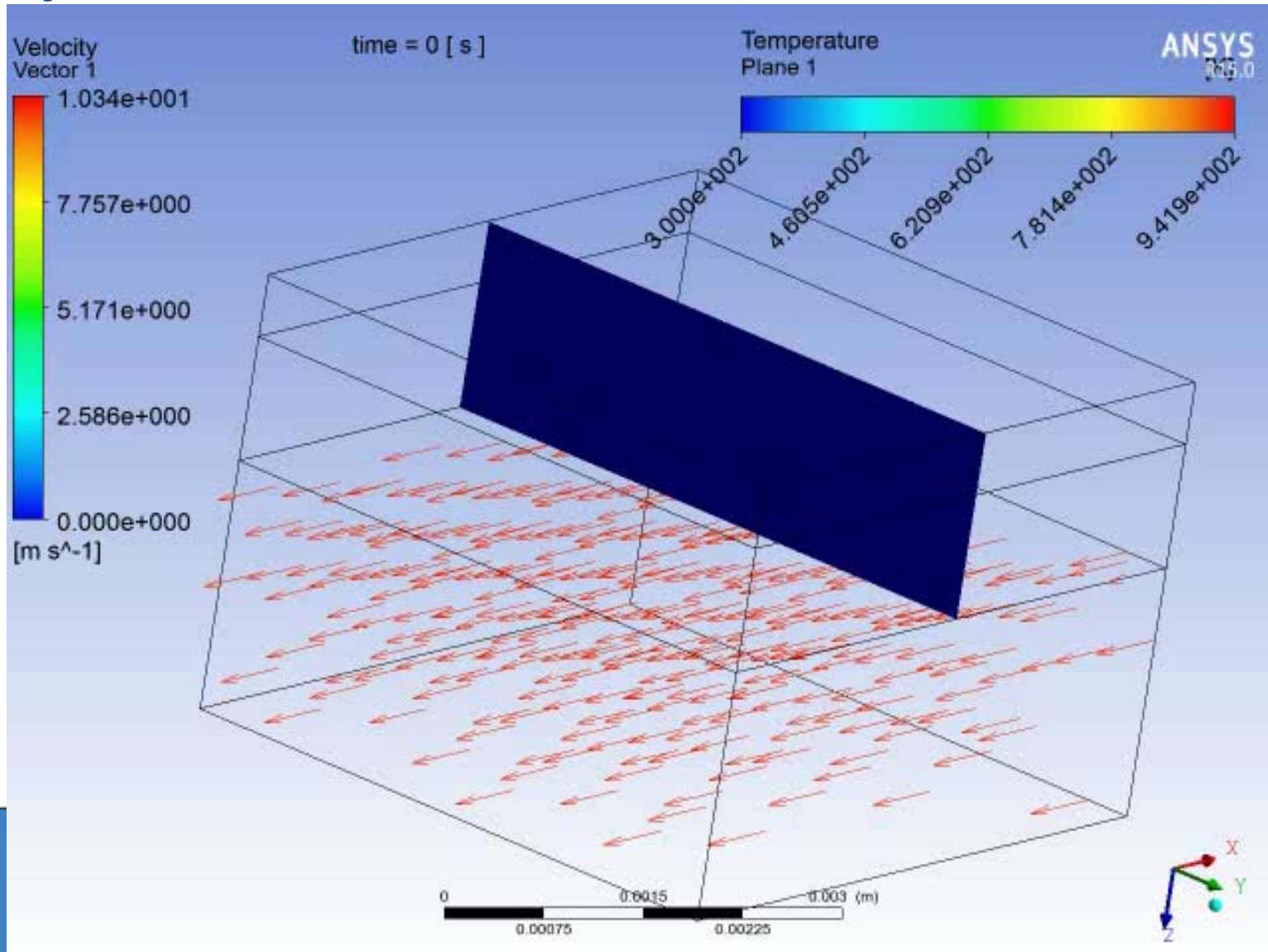

# Pulsed thermal power deposition

B: Transient Thermal  
Temperature  
Type: Temperature  
Unit: °C  
Time: 0.182  
30/07/2014 14:28



Temperature immediately after beam pulse

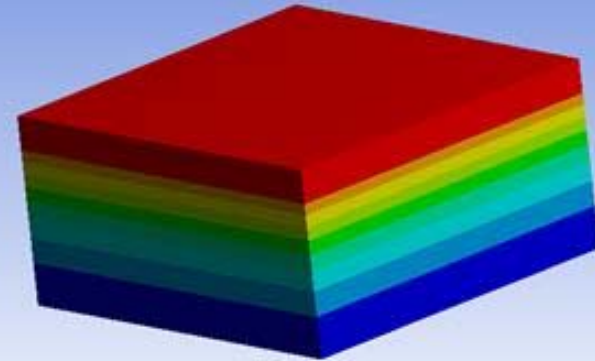

- Resultant temperature fluctuation depends on beam size
- Conduction in the sample during the 2ms beam pulse affects peak temperature
- Surface temperature similar to maximum temperature

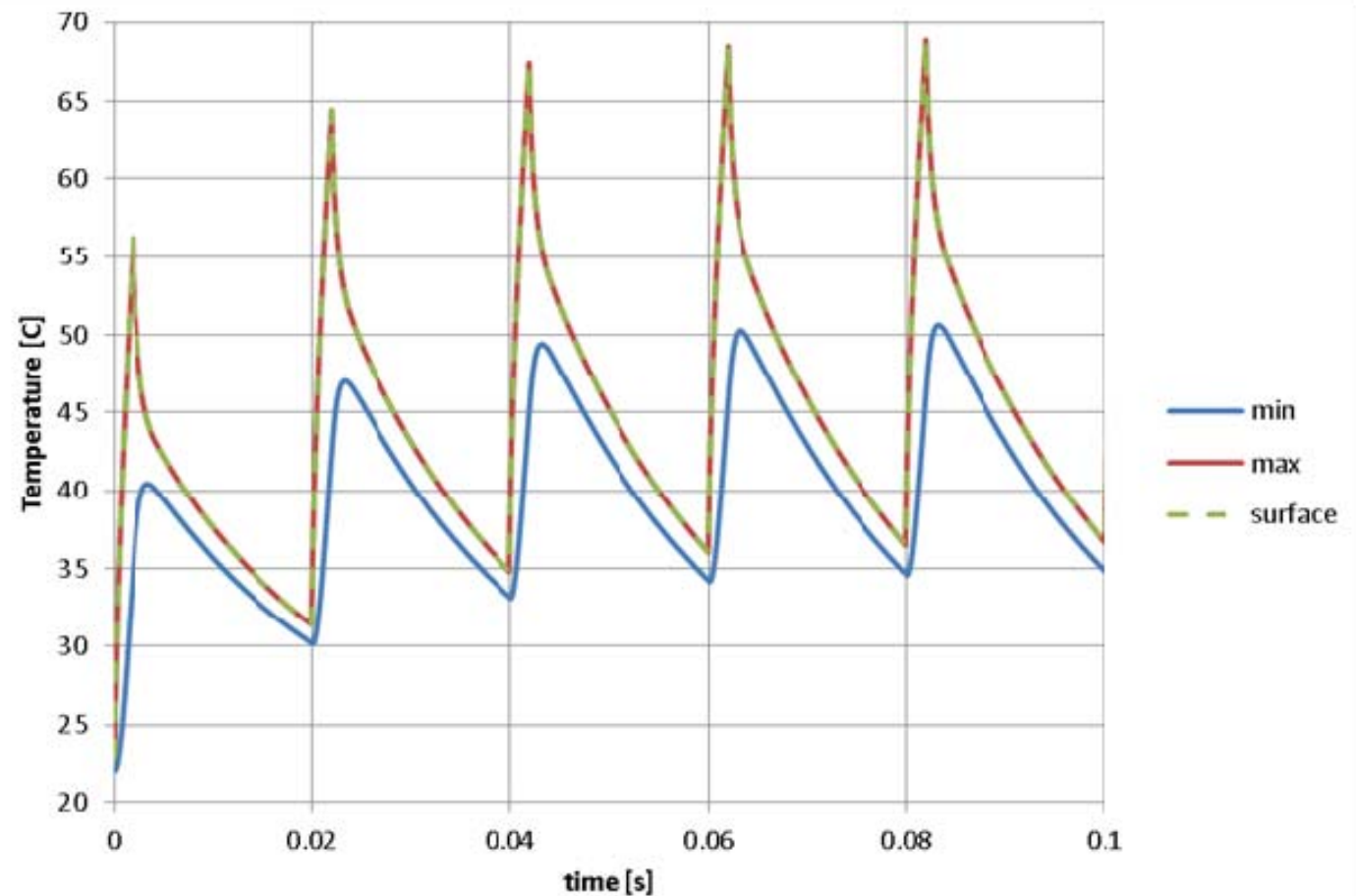



# Induced Stress in Sample

High stresses arise with a focused beam on the sample especially if it is perfectly bonded to a cooled back plate

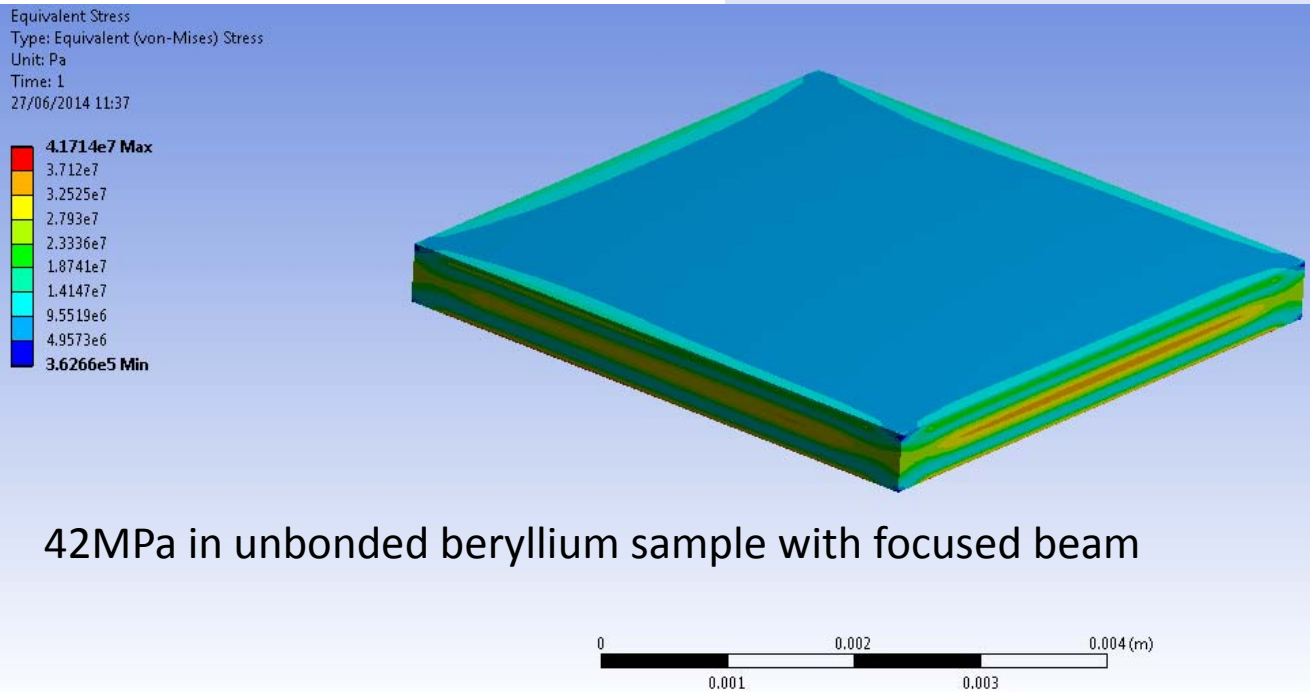
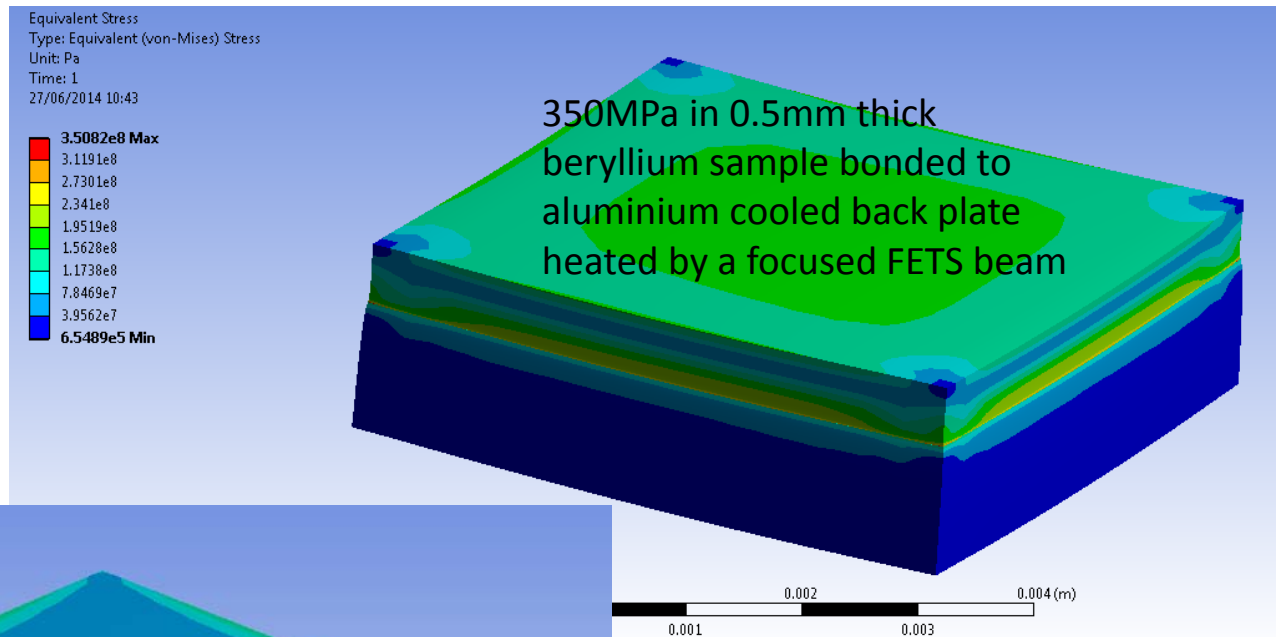

Maximum temperature and stress in samples depends on beam size, sample shape, and attachment to cooled back plate.



# FETS radiation shielding



- Shielding required for FETS aluminium beam dump
- More shielding required for materials generating more activity

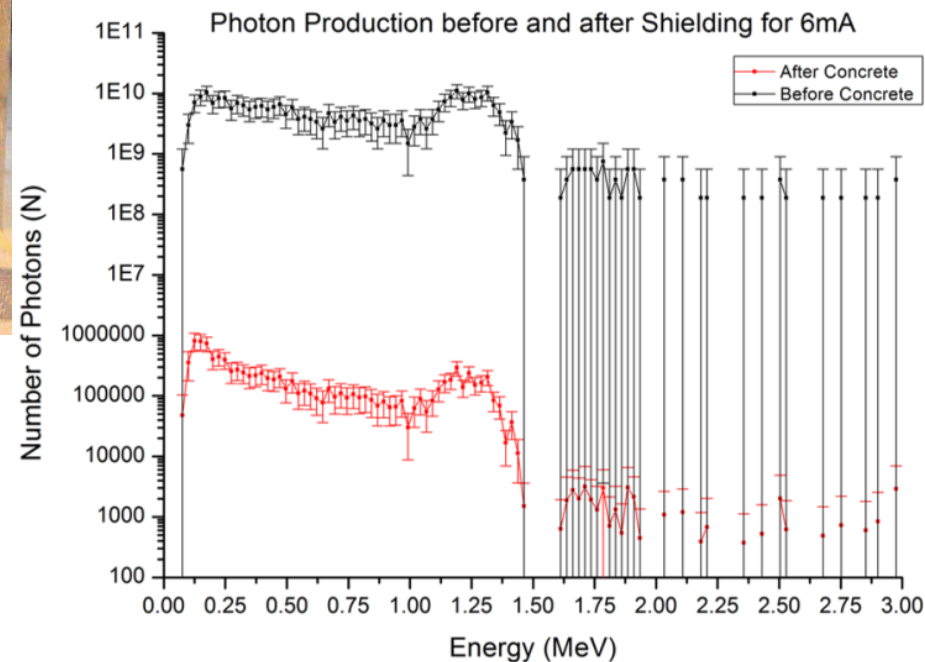

**RaDIATE Collaboration**

Radiation Damage In Accelerator Target Environments



# FETS-HIPSTER Summary

- Can deliver beam currents in excess of any existing irradiation facilities
- High dpa rates with manageable power density
- Deep enough irradiation to access bulk material properties
- Complementary e.g. to Birmingham Dynamitron
- Complementary (and a LOT cheaper) than proposed future facilities (TRITON, DCF, FAFNIR, IFMIF...)
- Proposal driven by fission and fusion materials community
- Support from senior UK lab management (RAL and Culham)
- On table for joint UK Research Council 'fusion for energy' strategy
- Proposal submitted to NNUF in July 2014

**RaDIATE Collaboration**

Radiation Damage In Accelerator Target Environments

