

Protons after bombarding the target at MOMENT

NuFact2015

Rio de Janeiro, Brazil
10th - 15th Aug 2015

Cai MENG

Institute of High Energy Physics, CAS, Beijing



Introduction and Motivation



Methods research



Simulation results



Summary

1. Introduction: MOMENT

MOMENT

- MOMENT: A muon-decay medium baseline neutrino beam facility
 - *CW proton superconducting linac* for proton driver
 - *Beam: 15 MW / 1.5 GeV / 10 mA*

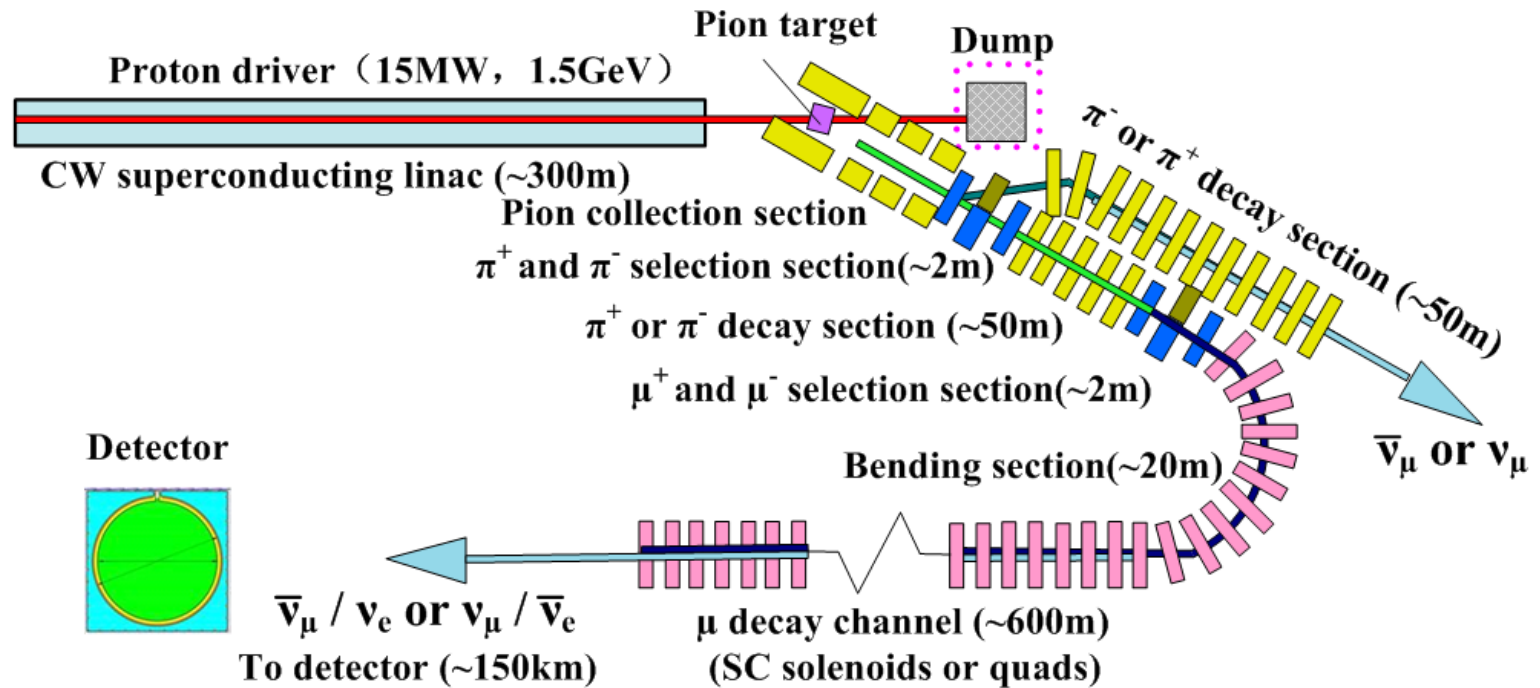

1. Introduction: **MOMENT** target station

MOMENT

- Main solenoid: Pion target, 14 T, about 1 m
- Capture solenoid: adiabatic, about 3 T, about 1 m
 - End of capture solenoid (beam loss)
- Pion collection channel: about 3 T, about 0.3 m

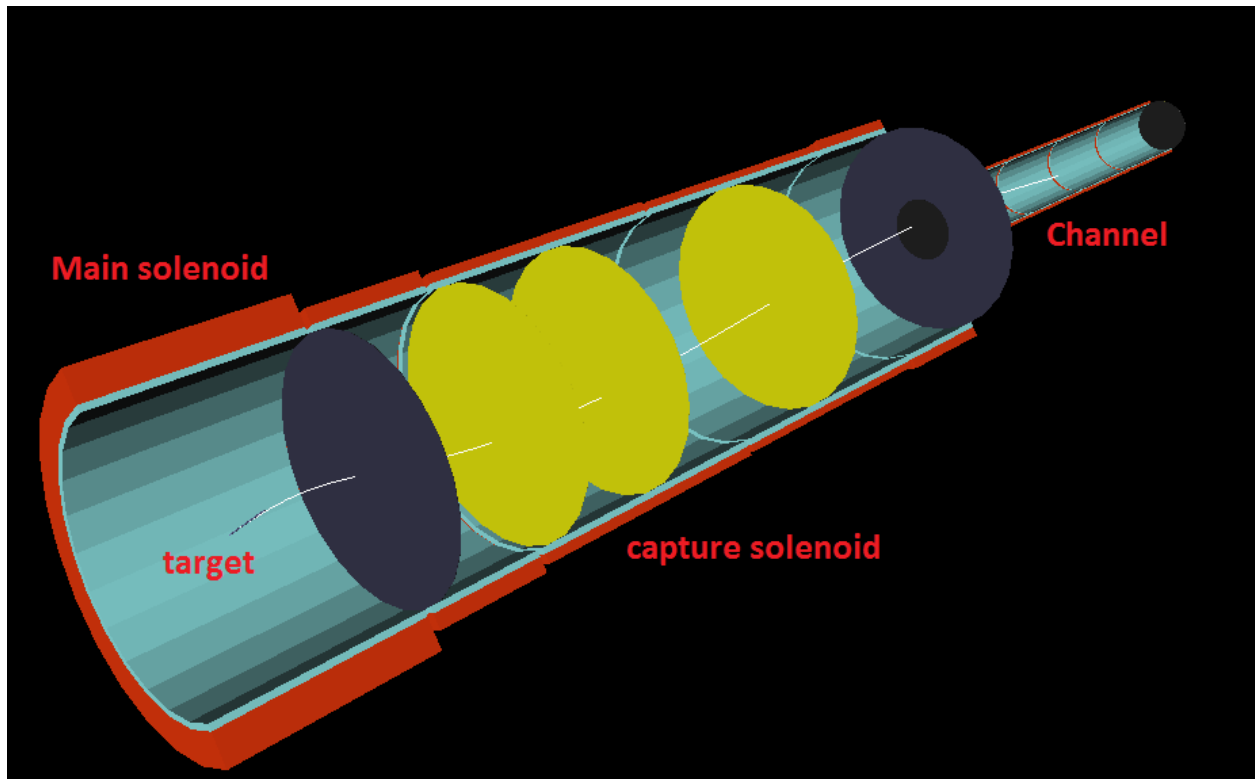

1. Motivation

- Very high beam power at target 15 MW
- Protons after bombarding the target
 - High momentum proton ~ 5 MW
 - Medium momentum proton ~ 0.8 MW
 - Low momentum proton ~ 1 MW, same as Pion momentum
- Energy deposition: Cooling and Shield
- Separate high momentum proton from target area to reduce the difficulty of target design without reducing pion collection efficiency greatly

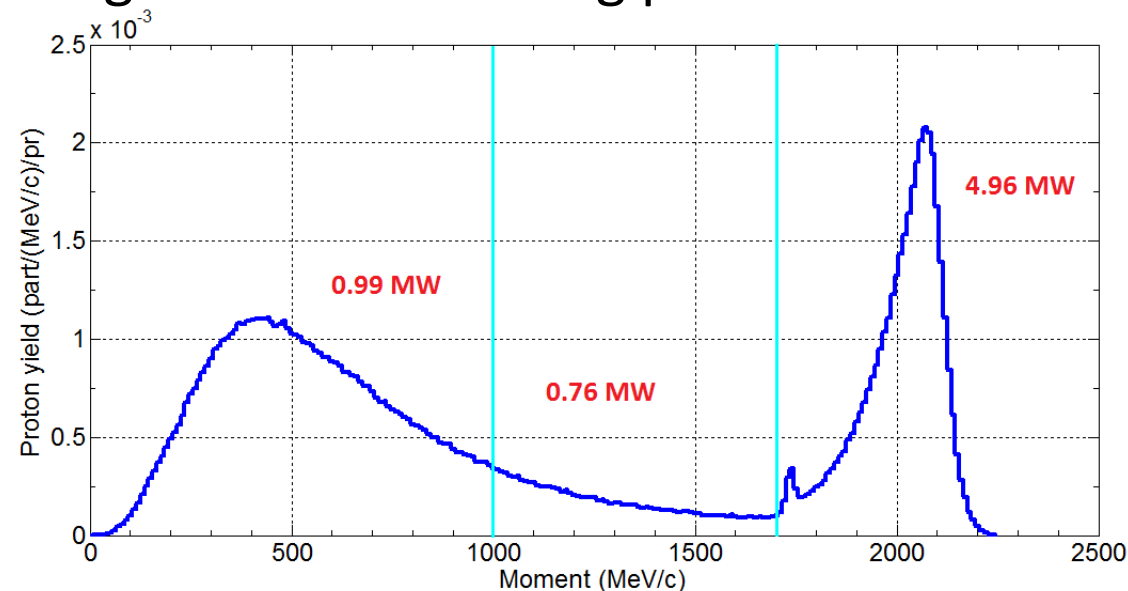

2. Method research → J-parc Neutrino Facility

MOMENT

- Beam: 1.66 MW / 30 GeV
- 3 Horn-→linear decay channel-→ Beam Dump

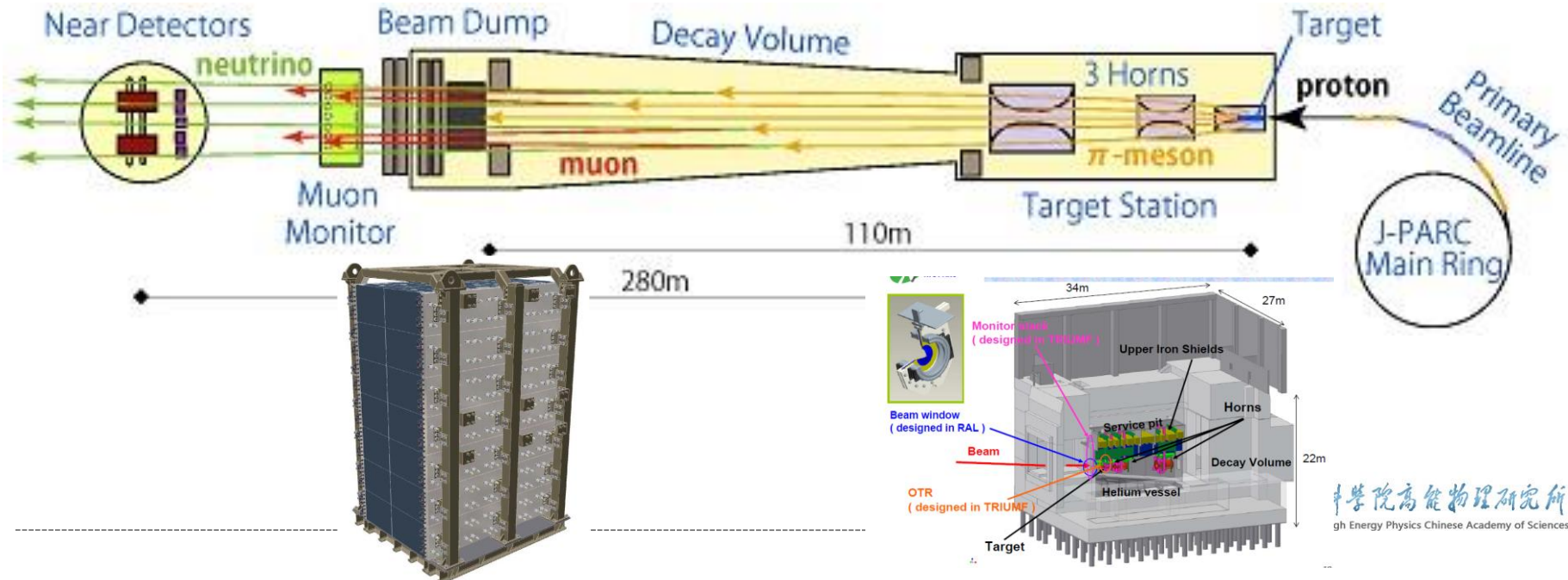

2. Method research → EUROnuSB

MOMENT

- Beam: 4 MW / 5 GeV
- Horns-→linear decay channel-→ Beam Dump

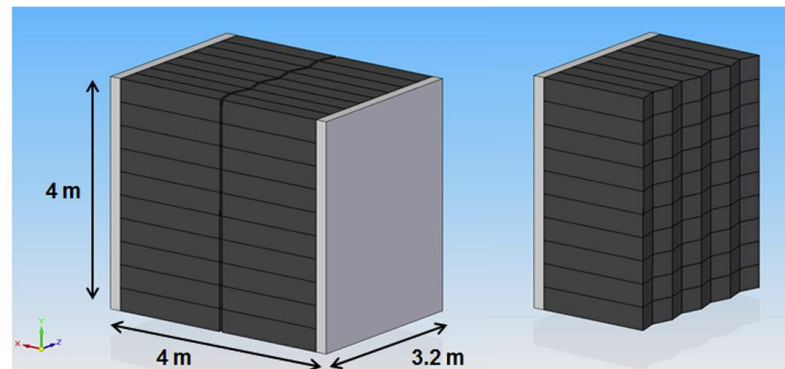
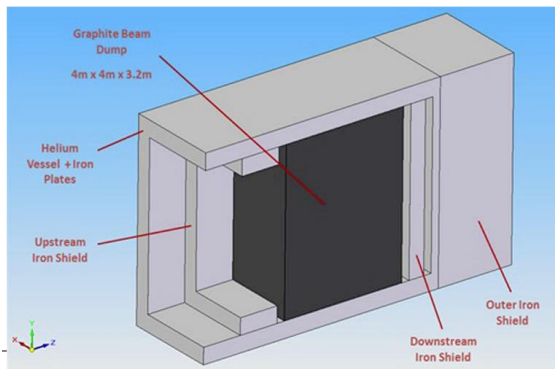
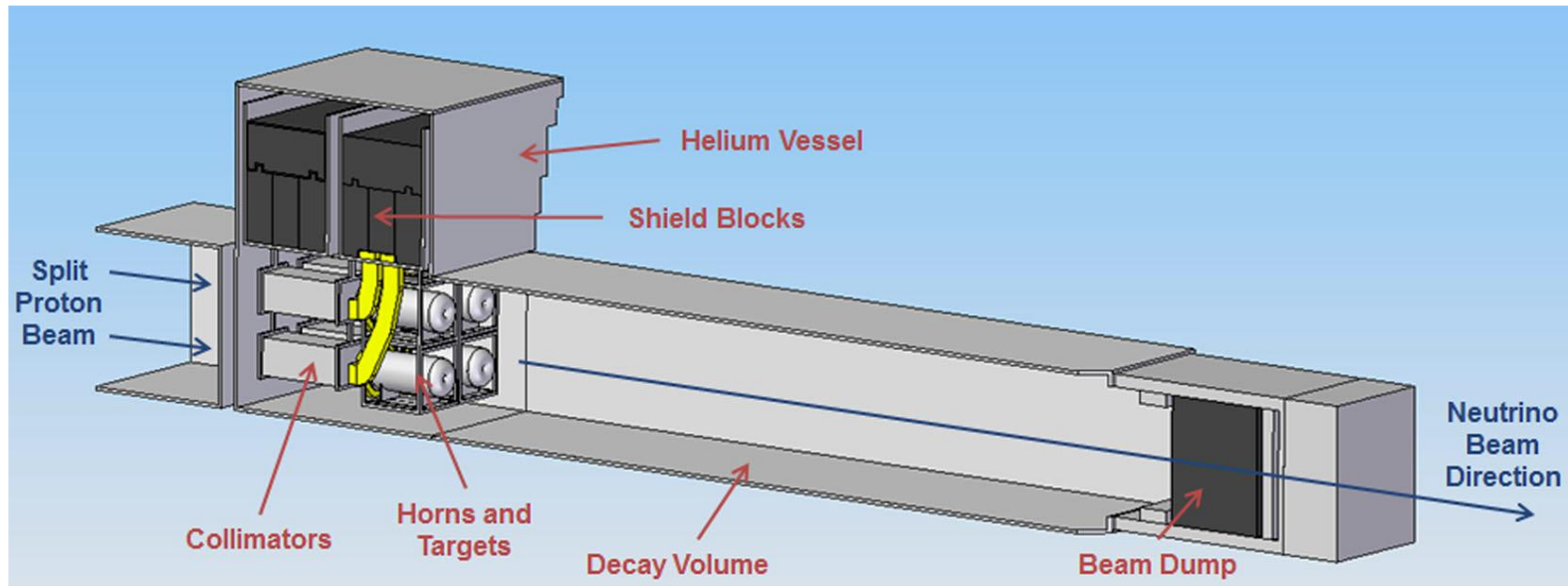

2. Method research → Neutrino Factory

MOMENT

- Beam: 4 MW / 8 GeV

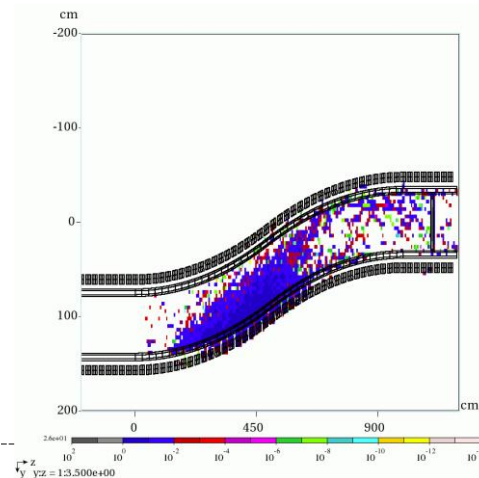
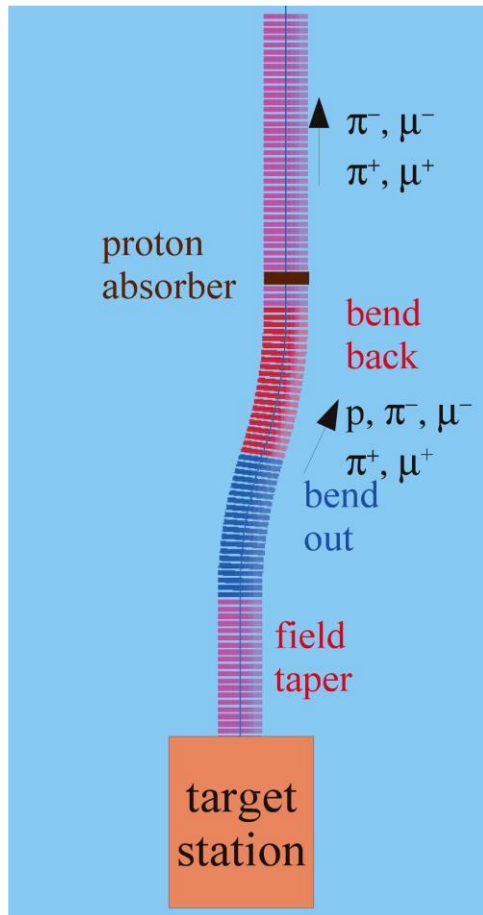
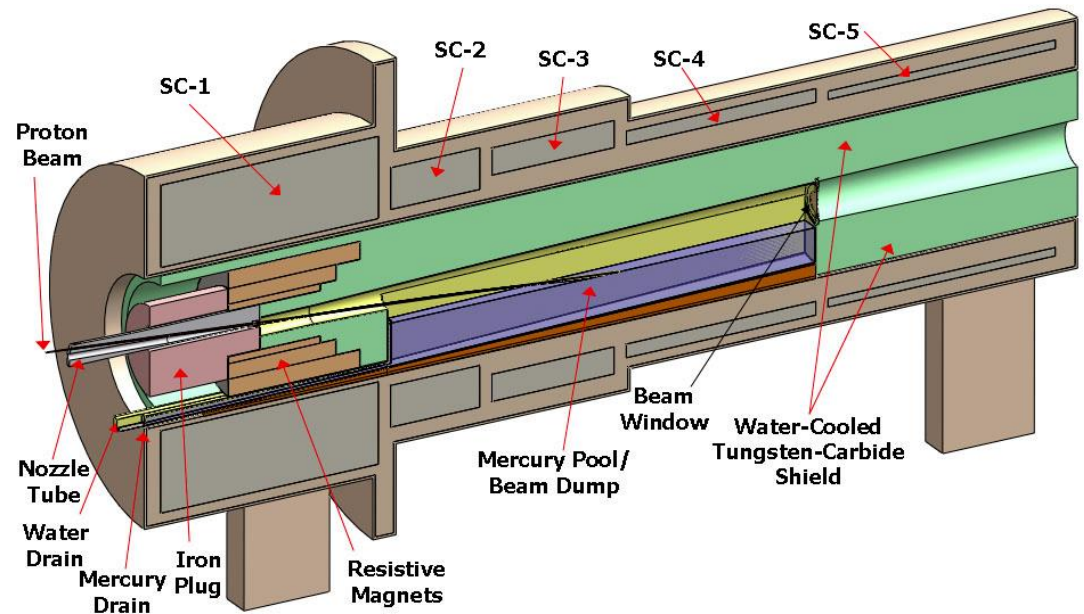

- Mercury pool serves as the proton beam-dump
 - High energy proton
 - a 12.5° **chicane** angle
 - Medium energy proton
 - 100 mm **proton absorber** (Beryllium)
 - Low energy proton



3. MOMENT Method study

- Features

- Beam:

- 1.5 GeV, difficult to take beam power by mercury pool for low energy
 - 6.7 MW

- Layout:

- complex, not linear channel
 - Different momentum, different magnetic rigidity, different gyration radius
 - *A separate channel for high momentum proton*

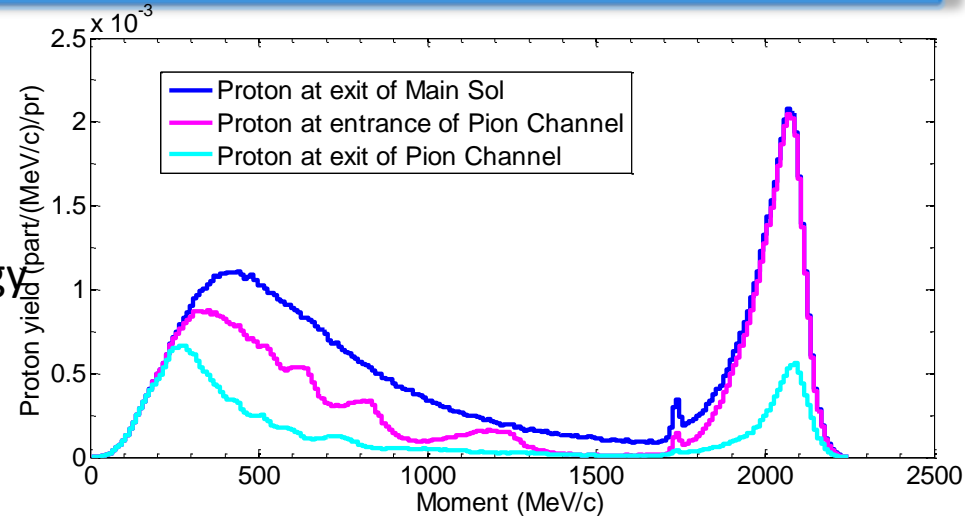

Proton	Low	medium	High	total
	MW			
Exit of main sol	0.99	0.76	4.94	6.69
Entrance of Pion channel	0.54	0.27	4.53	5.34
Exit of Pion channel (5 m)	0.2	0.1	1.14	1.44

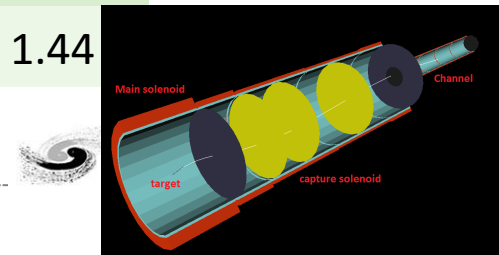

3. MOMENT → Momentum spectra

- After Main solenoid
 - Pion momentum \sim low momentum proton

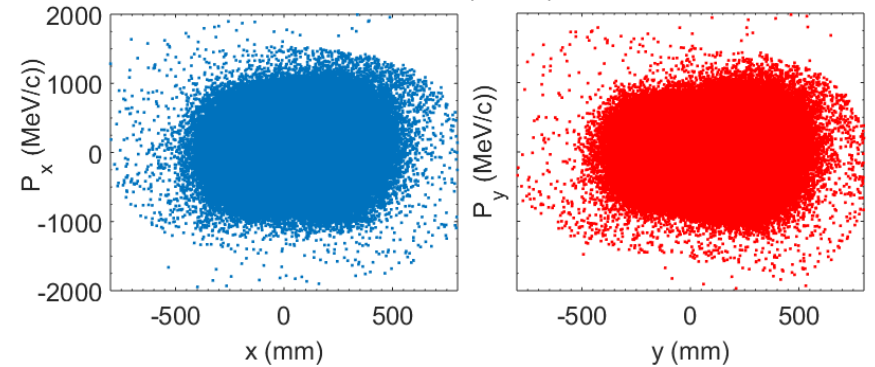
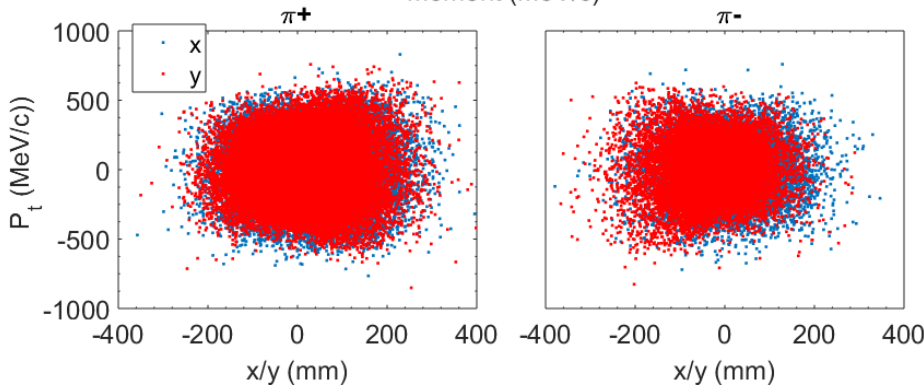
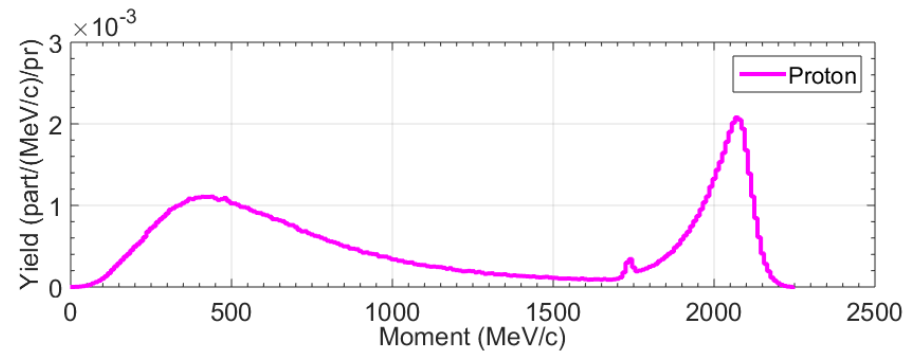
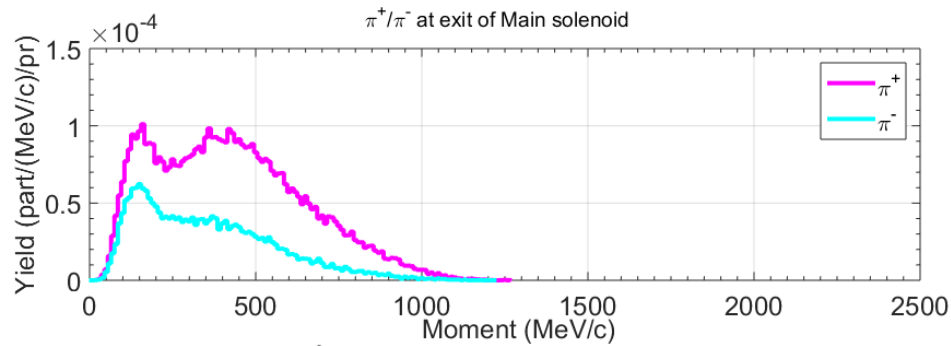

3. MOMENT → Method study

- Different field will cause different tracking with different momentum
 - Higher momentum → bigger gyration radius: **separation**
 - Lower field → bigger gyration radius: **separation**
 - 10 T scheme (Capture solenoid), obvious separation in different momentum
 - 14 T scheme (Capture solenoid), all particles transport in the center of solenoid

Field length

10T scheme

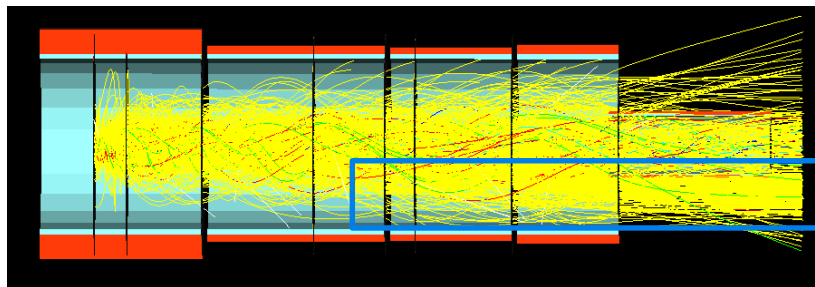

14T scheme: *baseline scheme*

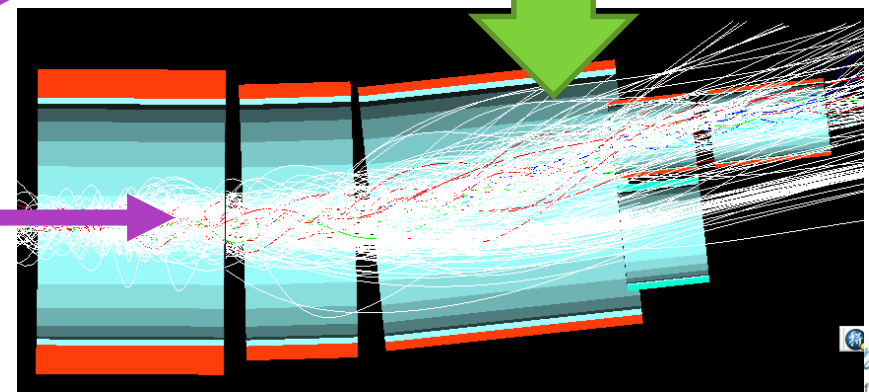
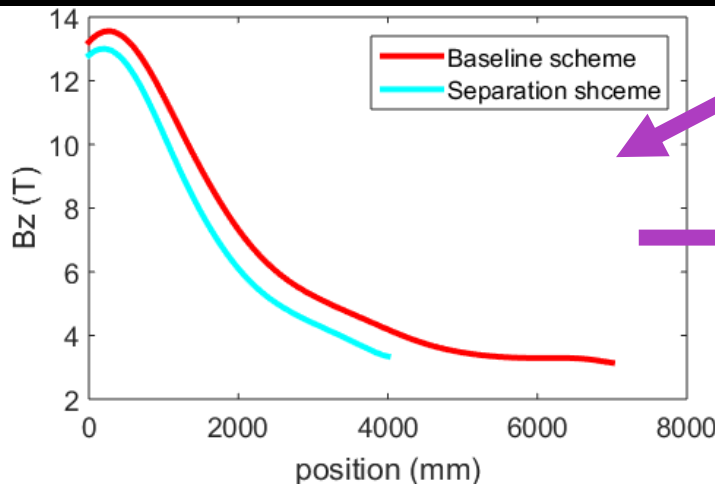
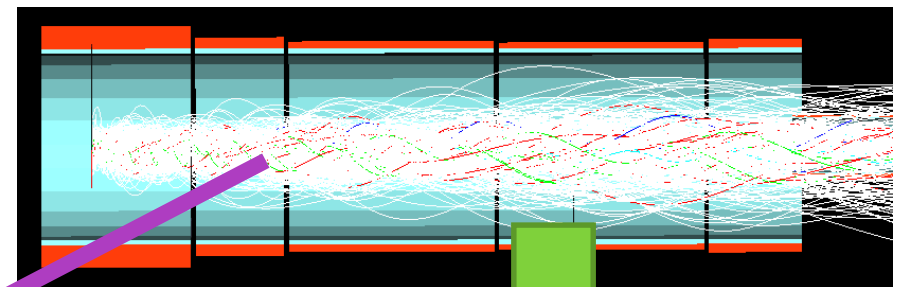

Separation scheme

3. MOMENT \rightarrow Method study

- High momentum proton separation
 - Solenoid field: above analysis (magnetic field & length)
 - Deflection field: different magnetic rigidity, high momentum proton and low momentum proton (same as Pion) will be separated.
 - Bending solenoid angle: **important**
 - Collection channel aperture:

- Complex field
- large divergence angle

Optimization is difficult

$$\frac{d\vec{p}}{dt} = q \cdot \frac{\vec{p}}{\gamma m} \times \vec{B}$$

$$\begin{cases} \dot{p}_x = \frac{dp_x}{dt} = q \cdot \frac{p_z}{\gamma m} (y' \cdot B_z - B_y) \\ \dot{p}_y = \frac{dp_y}{dt} = q \cdot \frac{p_z}{\gamma m} (-x' \cdot B_z + B_x) \\ \dot{p}_z = \frac{dp_z}{dt} = q \cdot \frac{p_z}{\gamma m} (x' \cdot B_y - y' \cdot B_x) \end{cases}$$

$$\frac{dx'}{ds} = \frac{d(p_x/p_z)}{dt} \cdot \frac{dt}{ds} = \frac{1}{\beta_z c} \frac{\dot{p}_x - \dot{p}_z \cdot x'}{p_z}$$

$$\frac{dx'}{ds} = \frac{q}{\beta_z \gamma m c} \left[x' y' \cdot B_x - (1 + x'^2) \cdot B_y + y' \cdot B_z \right]$$

$$\frac{dy'}{ds} = \frac{q}{\beta_z \gamma m c} \left[-x' y' \cdot B_y + (1 + y'^2) \cdot B_x - x' \cdot B_z \right]$$

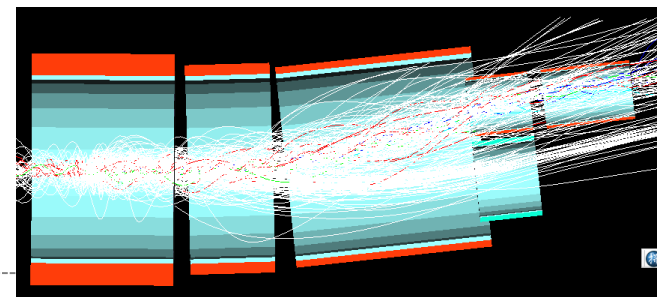
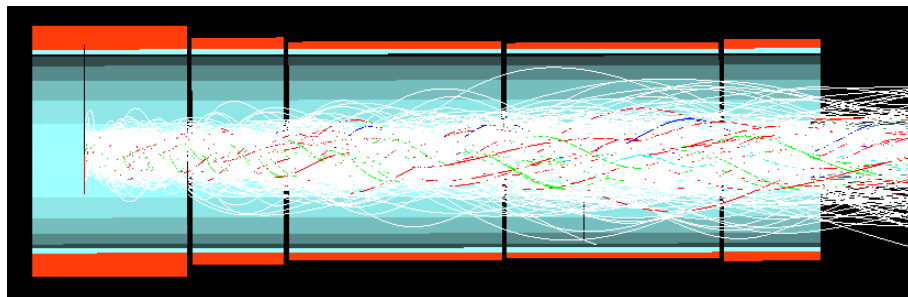

3. MOMENT \rightarrow Simulation results

Pion collection at the baseline scheme

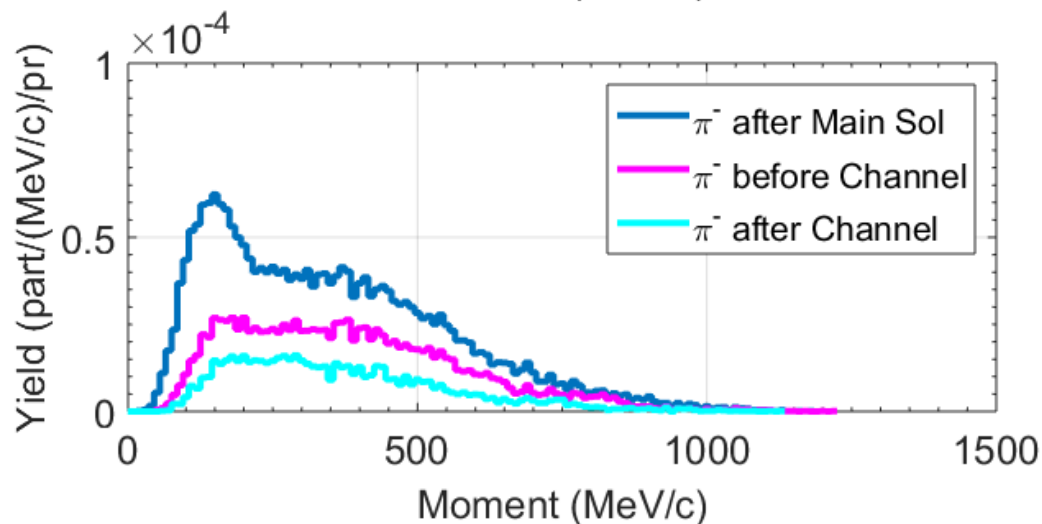
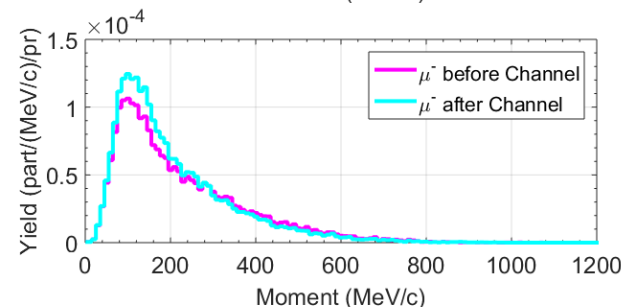
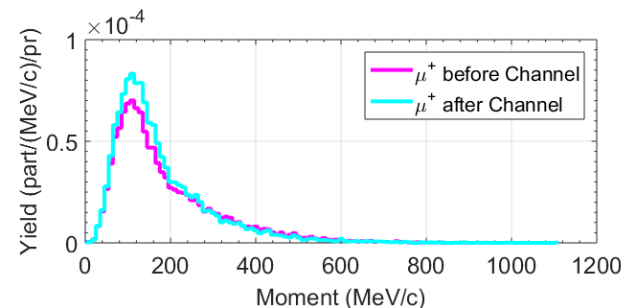
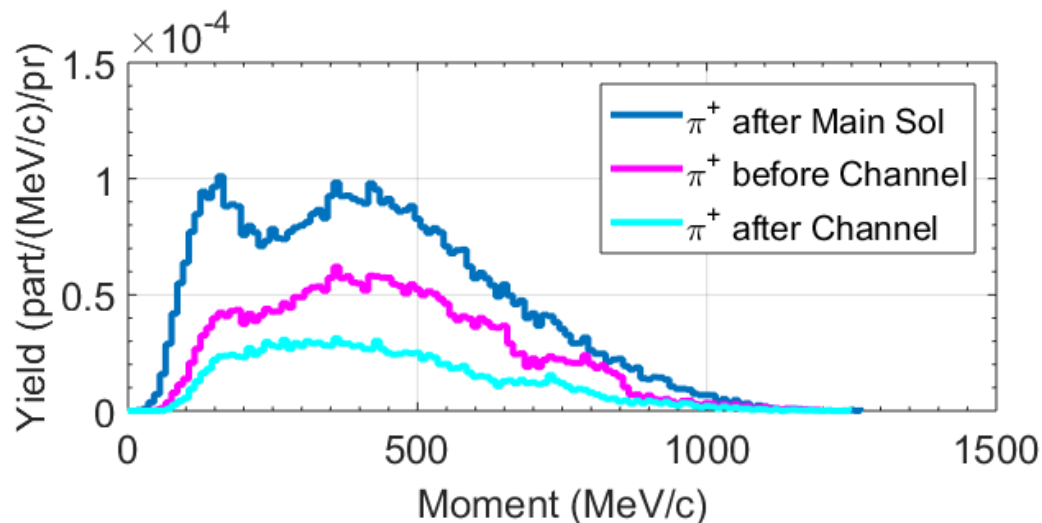

	Yield/ 10^{-2}	π^+	π^-
Exit of main sol		5.55	2.33
Entrance of Pion channel		3.10	1.25
Exit of Pion channel (5 m)		1.56	0.64

3. MOMENT → Simulation results

Proton separation at the separation scheme

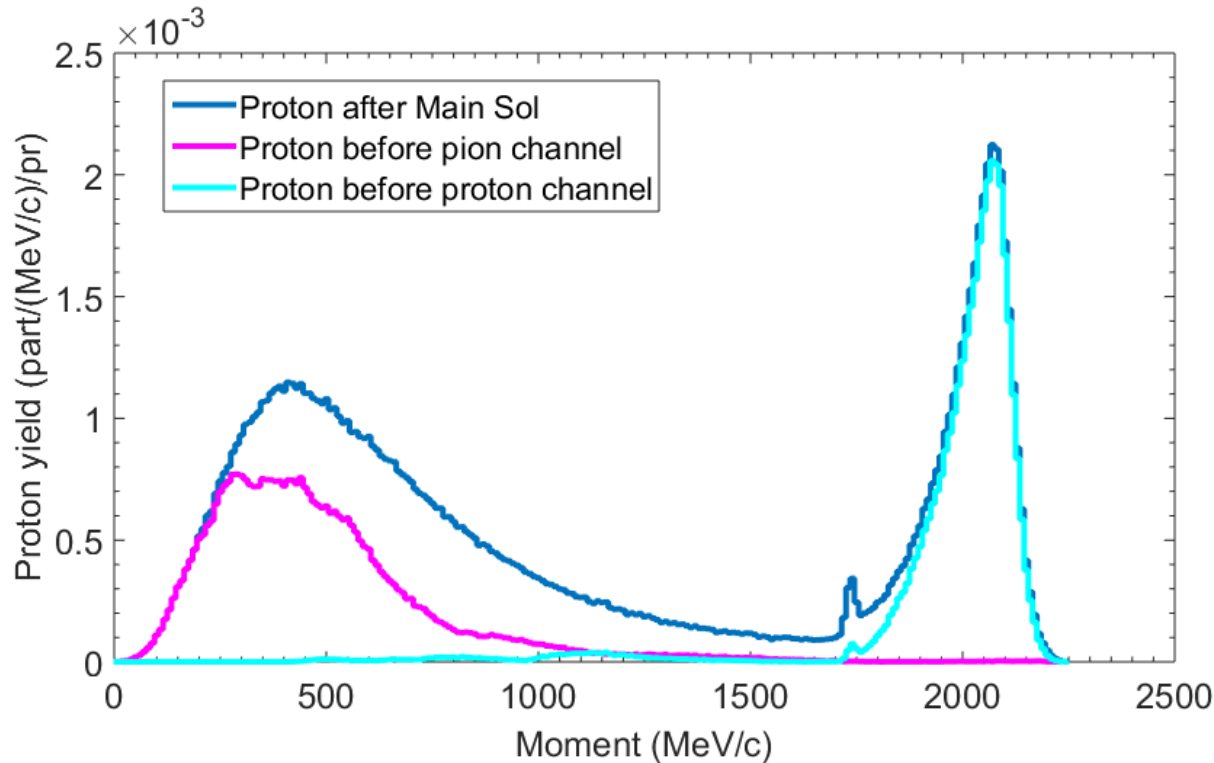

High momentum proton separation efficiency: **89%**

Still about **1.7 MW** proton beam lost in target station

Proton	Low	medium	High	total
	MW			
Exit of main sol	1.01	0.76	4.97	6.74
Entrance of pion channel	0.41	0.11	0.01	0.53
Entrance of proton channel	0.016	0.06	4.43	4.51

3. MOMENT Simulation results

Pion collection at the separation scheme

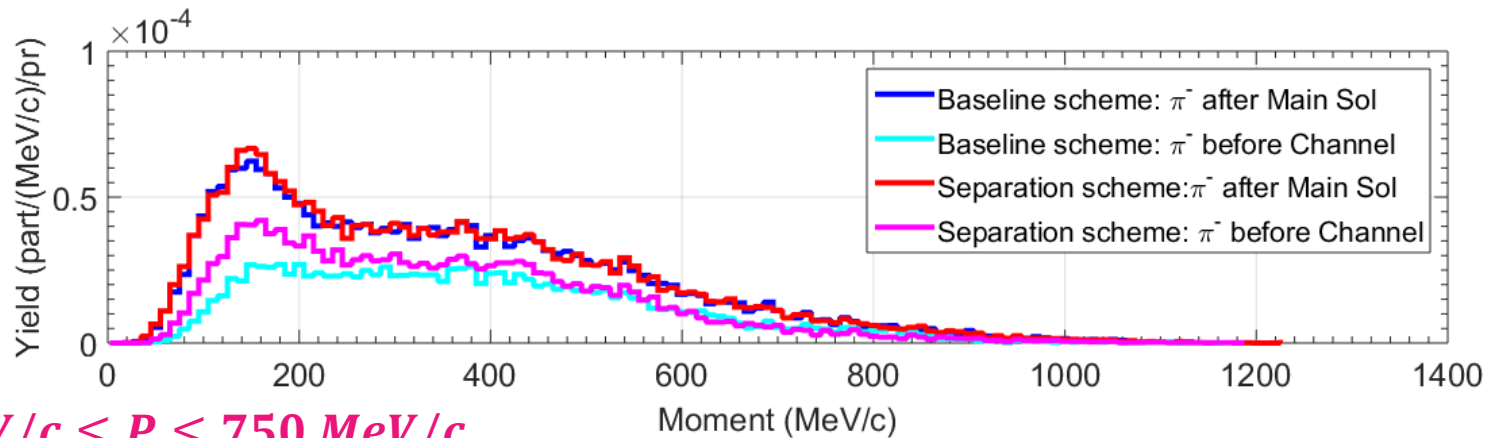
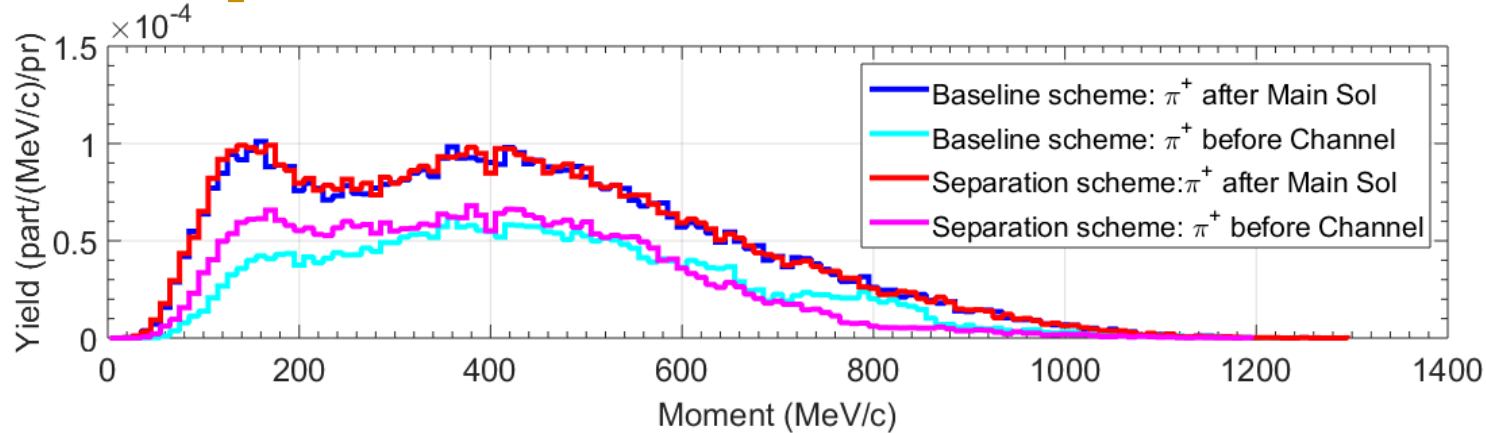

Cutoff: $200 \text{ MeV/c} \leq P \leq 750 \text{ MeV/c}$

Yield/ 10^{-2}	Total π^+	Total π^-	Cutoff π^+	Cutoff π^-
Baseline scheme	3.10	1.25	2.4	0.93
Separation scheme	3.37	1.52	2.59	1.07

70%

3. MOMENT \rightarrow Simulation results

π^+ distribution before pion channel

Baseline scheme

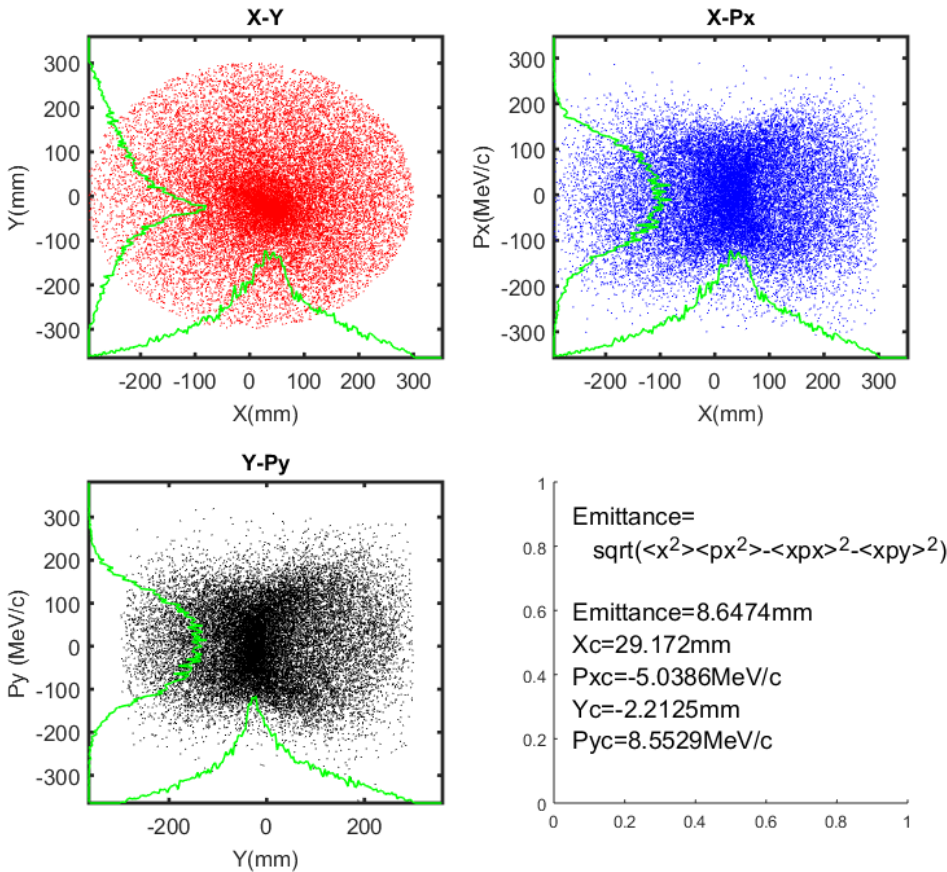

Separation scheme

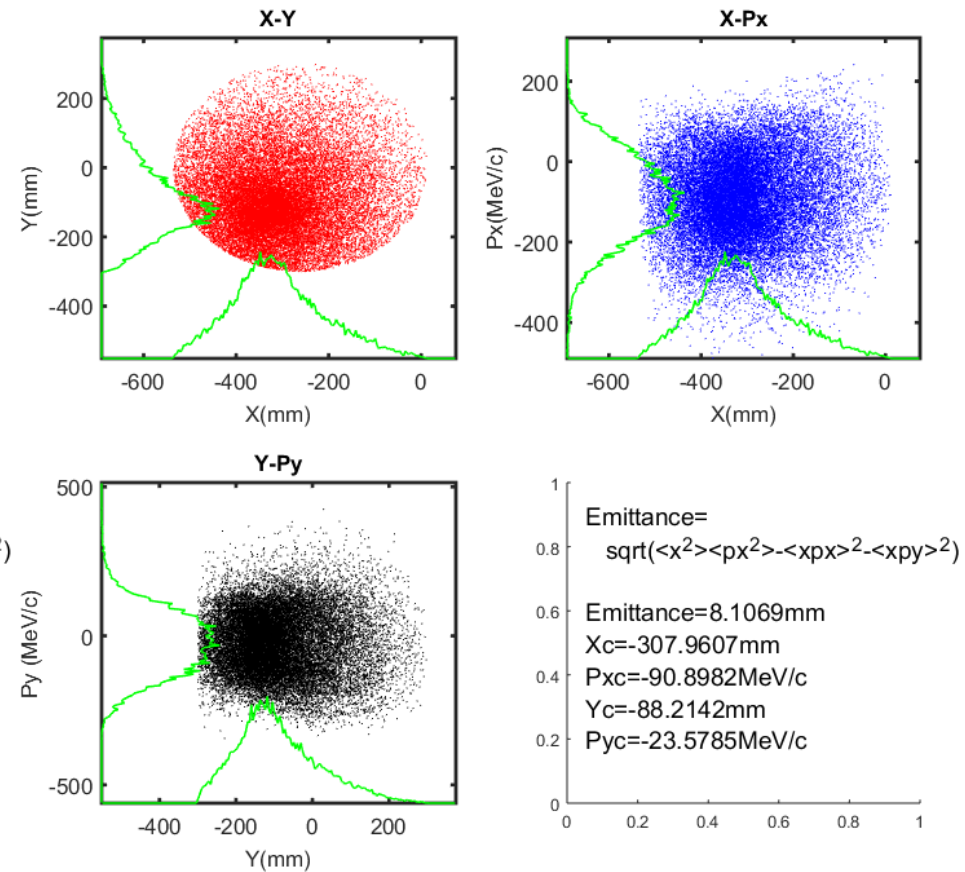

3. MOMENT Simulation results

MOMENT

π distribution before pion channel

Baseline scheme

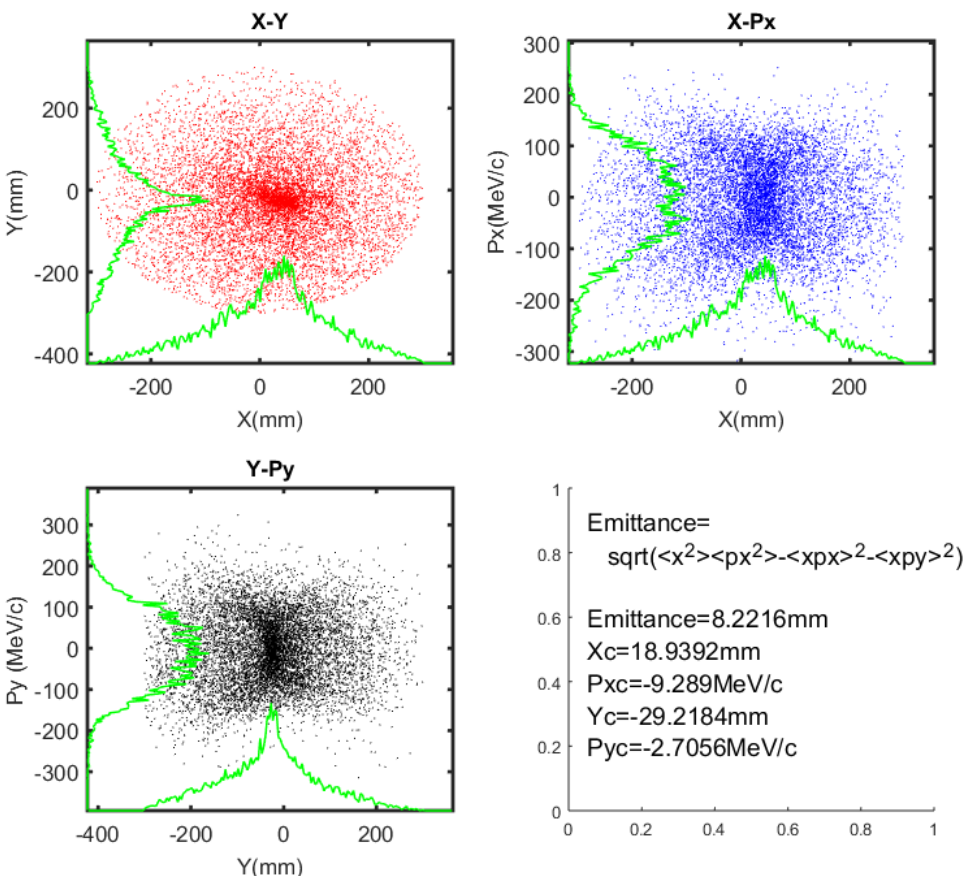

Separation scheme

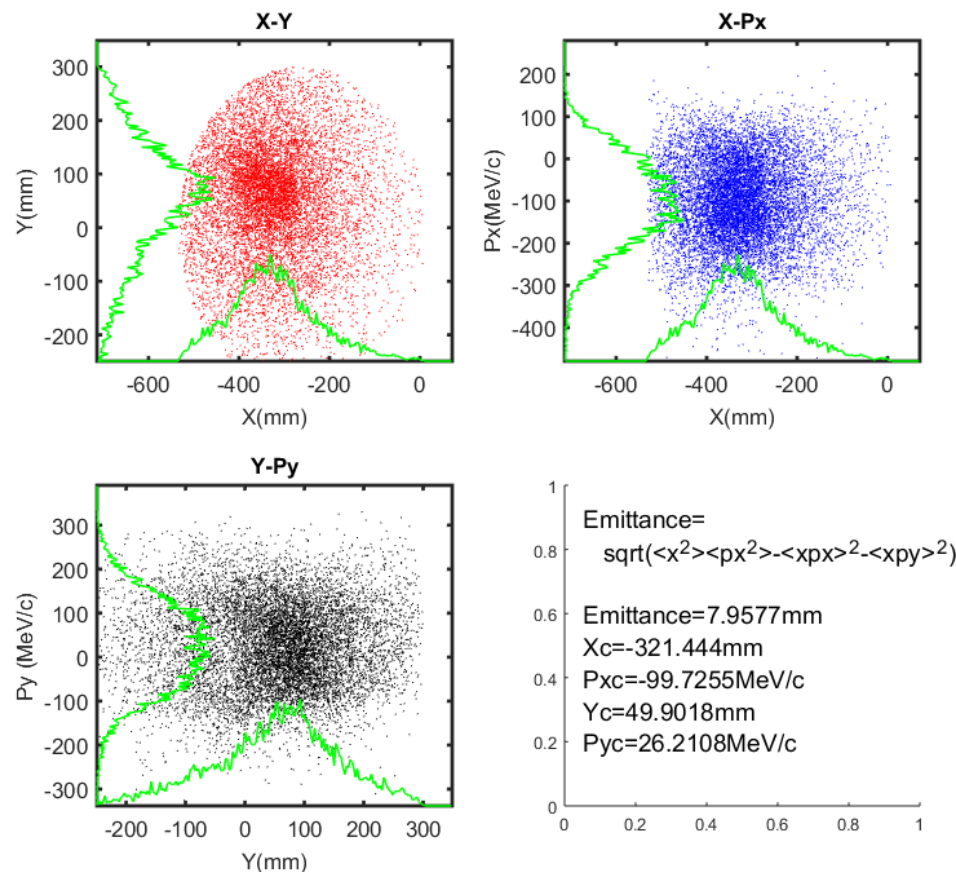

- Detailed analysis proton momentum after bombarding the target for MOMENT
- One method to separation high momentum proton, about 89% separation efficiency, without reducing pion collection efficiency
- Next optimization to be continued



Thank you for your attention!

