

Muon Bunching for a Muon Collider

David Neuffer
FNAL

August 3, 2010

- Motivation
 - $\mu^+ - \mu^-$ Collider
 - Multi-TeV high-energy collider

- Produce, collect and cool as many muons as possible
 - Start with v-Factory IDS design study
 - Reoptimize for Collider
 - Shorter bunch train
 - Higher energy capture, shorter front-end
 - Larger gradients

- v-Factory $\rightarrow \mu^+ - \mu^-$ Collider

- Discussion

Muon Collider Conceptual Layout

Project X
Accelerate hydrogen ions to 8 GeV using SRF technology.

Compressor Ring
Reduce size of beam.

Target
Collisions lead to muons with energy of about 200 MeV.

Muon Capture and Cooling
Capture, bunch and cool muons to create a tight beam.

Initial Acceleration
In a dozen turns, accelerate muons to 20 GeV.

Recirculating Linear Accelerator
In a number of turns, accelerate muons up to 2 TeV using SRF technology.

Collider Ring
Bring positive and negative muons into collision at two locations 100 meters underground.

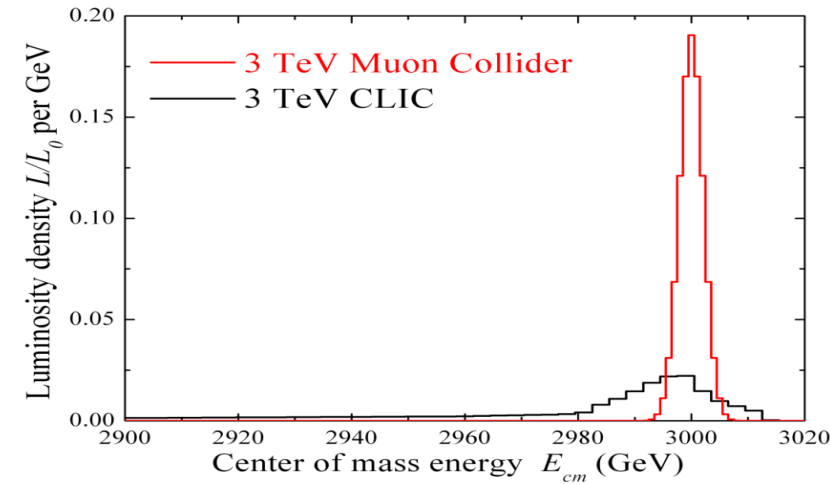
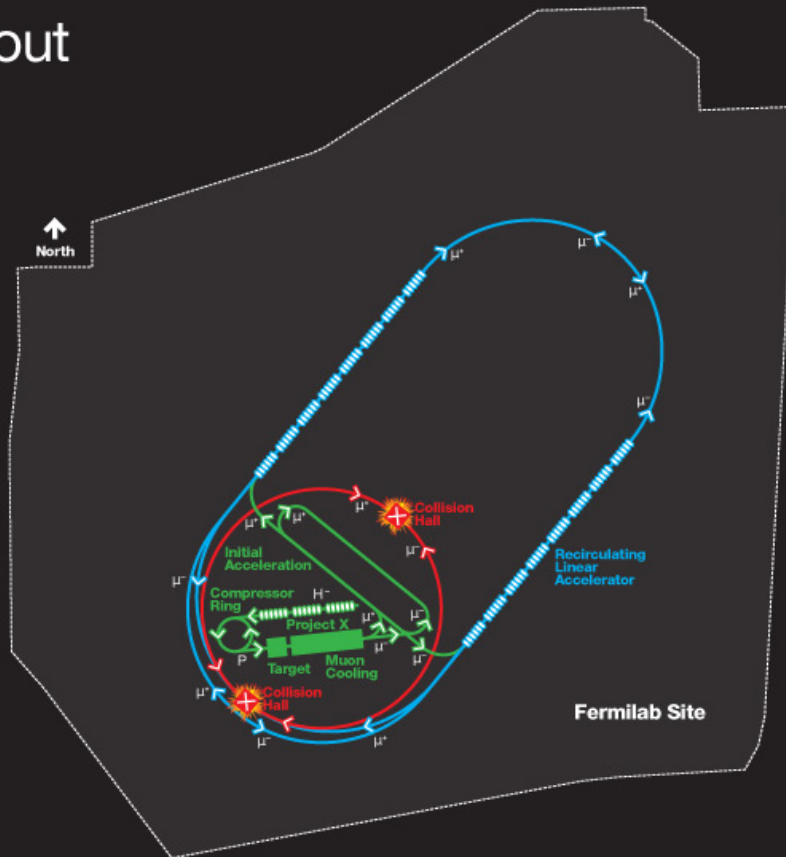

• *Beamstrahlung* in any $e+e-$ collider

- $\delta E/E \propto \gamma^2$

Need ~4MW pulsed proton source from Project X

Initial Project X is (currently) cw 3GeV linac
<1G\$
will need upgrade

- Baseline Muon Collider beam preparation system identical to that for Neutrino Factory
 - downstream portions (6D cooling, acceleration, collider) are distinct
 - much more cooling and acceleration needed for collider

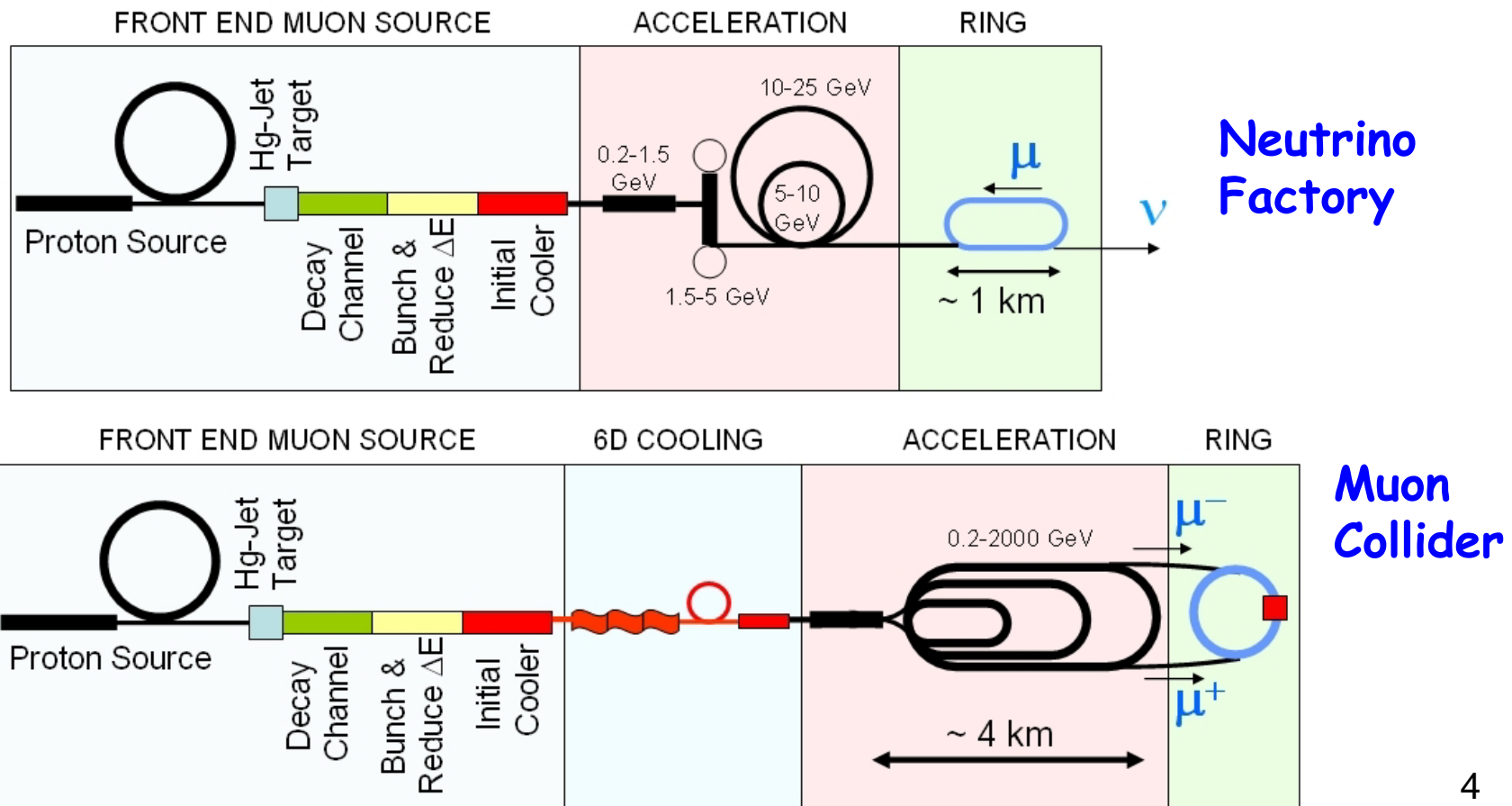

- **Muon Collider front end optimum is somewhat different**
 - Short bunch train preferred
 - Bunches are recombined later ...
 - Maximum μ /bunch wanted
 - Longitudinal cooling included; may accept larger δp
 - Larger rf gradient can be used (?)
 - NF will debug gradient limits
 - Cost is less constrained

- **For variant, we will have shorter BR system, more gradient, and capture at higher momentum**
 - 230 \rightarrow 270 MeV/c
 - 150m \rightarrow 120m
 - 9/12/15 MV/m \rightarrow 15/16/18 or 15/18/20 MV/m
 - 1.5T \rightarrow 2T

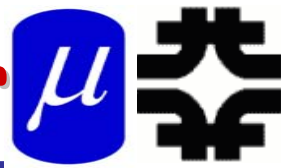

- Drift ($\pi \rightarrow \mu$)
- “Adiabatically” bunch beam first (weak 350 to 232 MHz rf)
- Φ -E rotate bunches - align bunches to ~equal energies
 - 232 to 202 MHz, 12MV/m
- Cool beam 201.25MHz

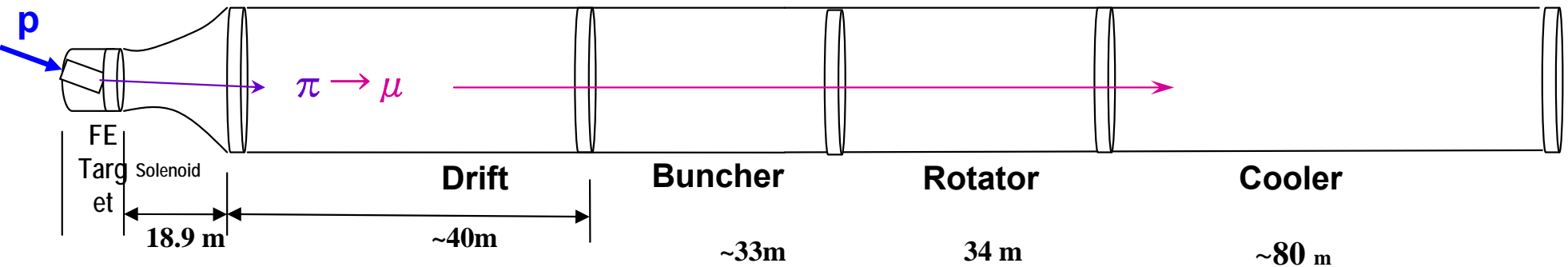
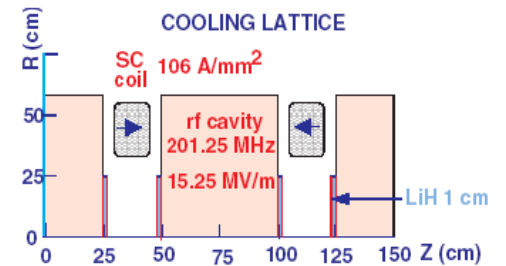
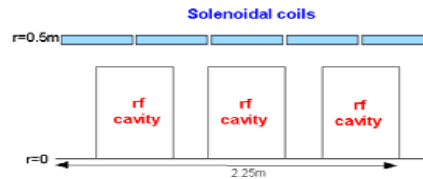

➤ End up with fewer, denser bunches

- More μ/p
- Larger δp

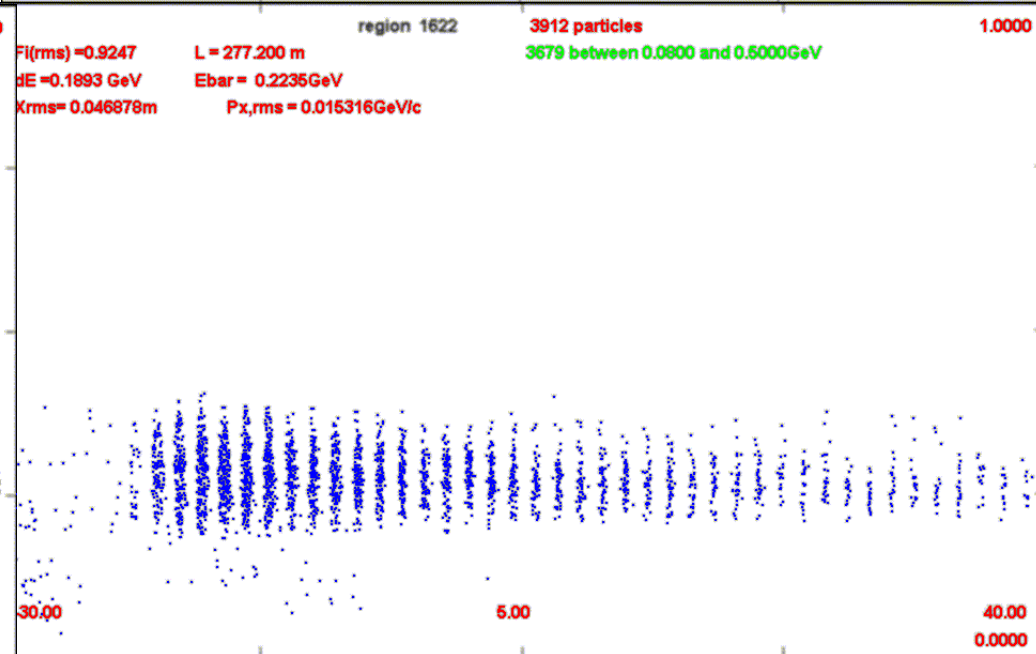
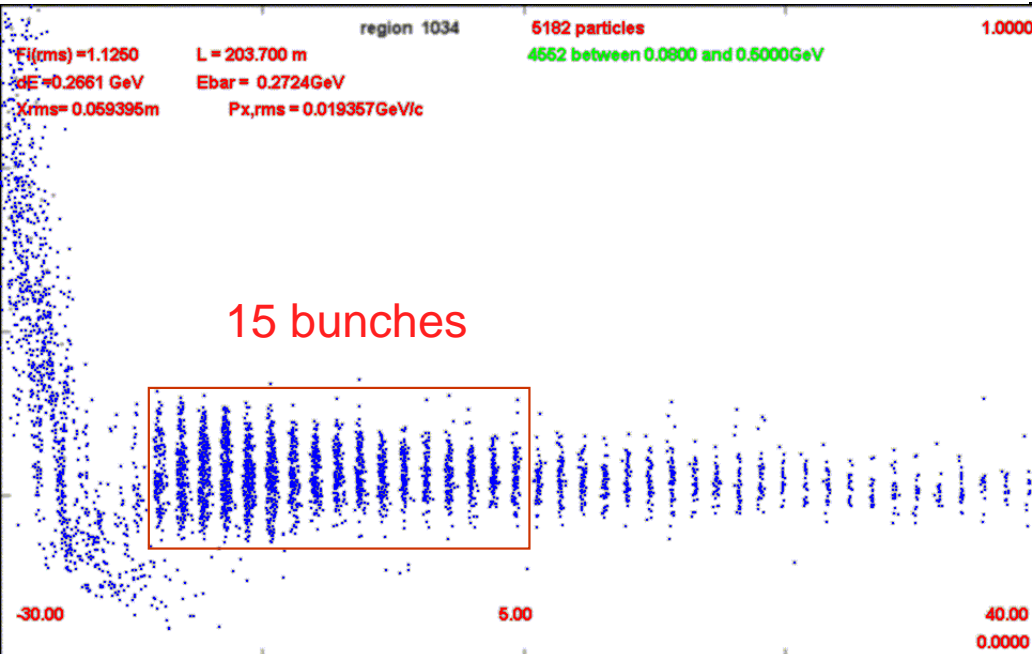
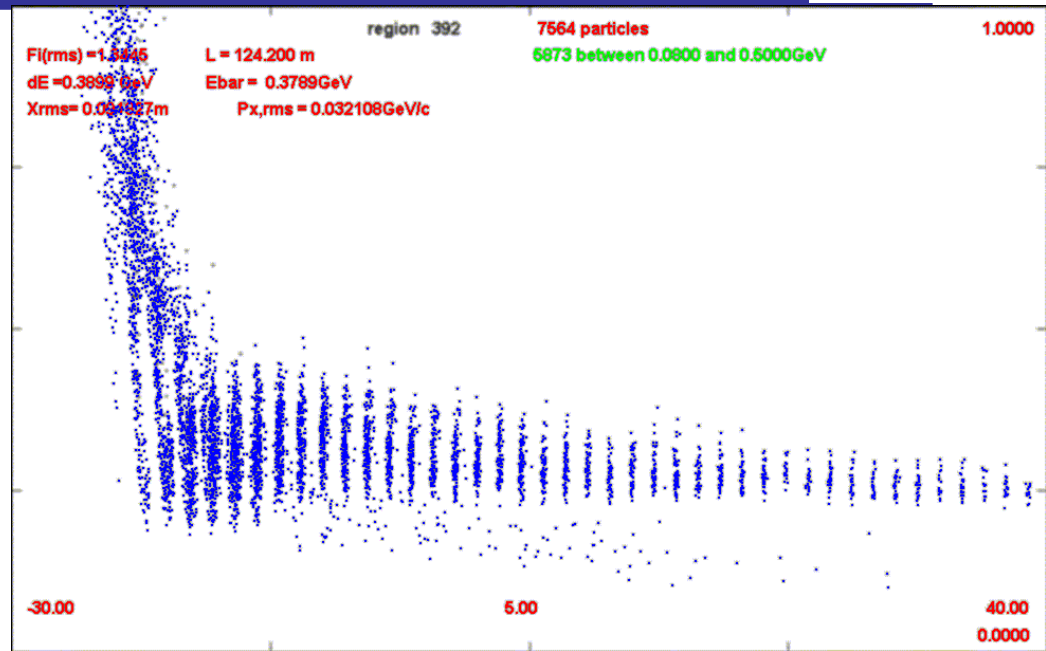

Neutrino Factory version

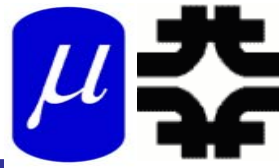

➤ NF baseline version

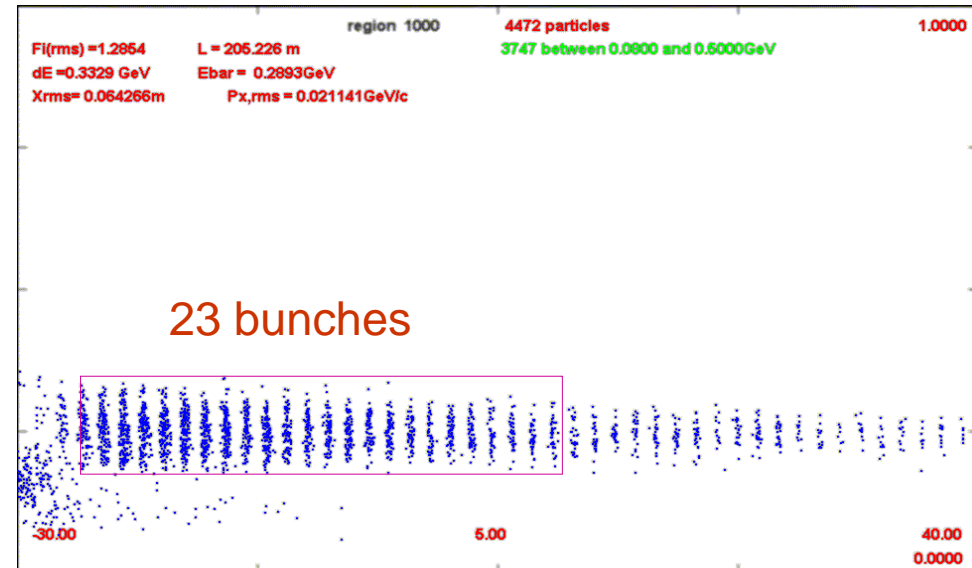
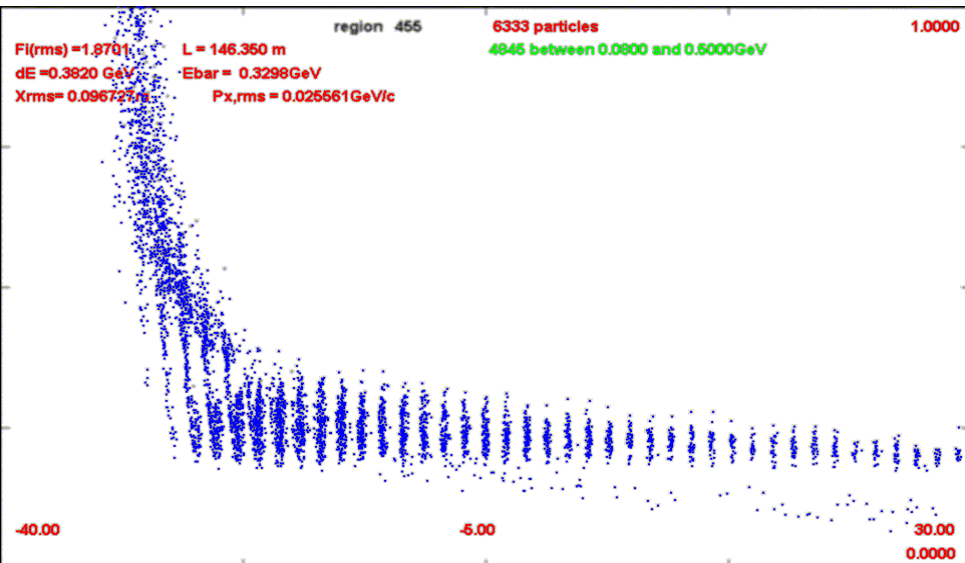
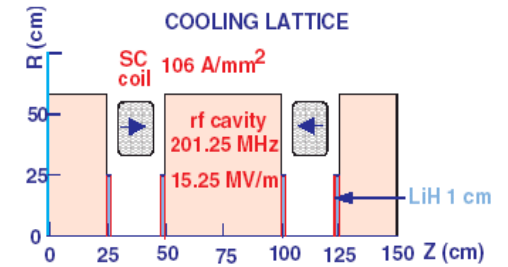
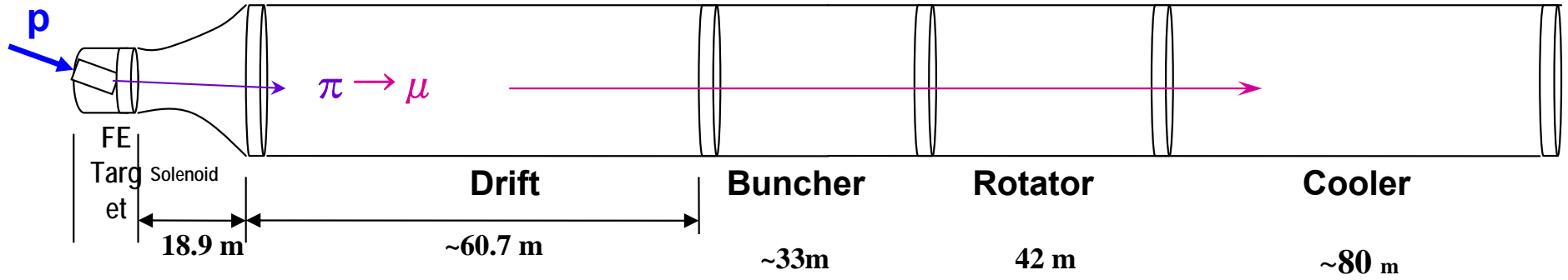

- Has ~30% shorter train
- More μ/p
 - ~0.12 μ/p (from ~0.09)
- Captures more of the "core" of the initial π/μ
 - Rather than lower half of the core ...

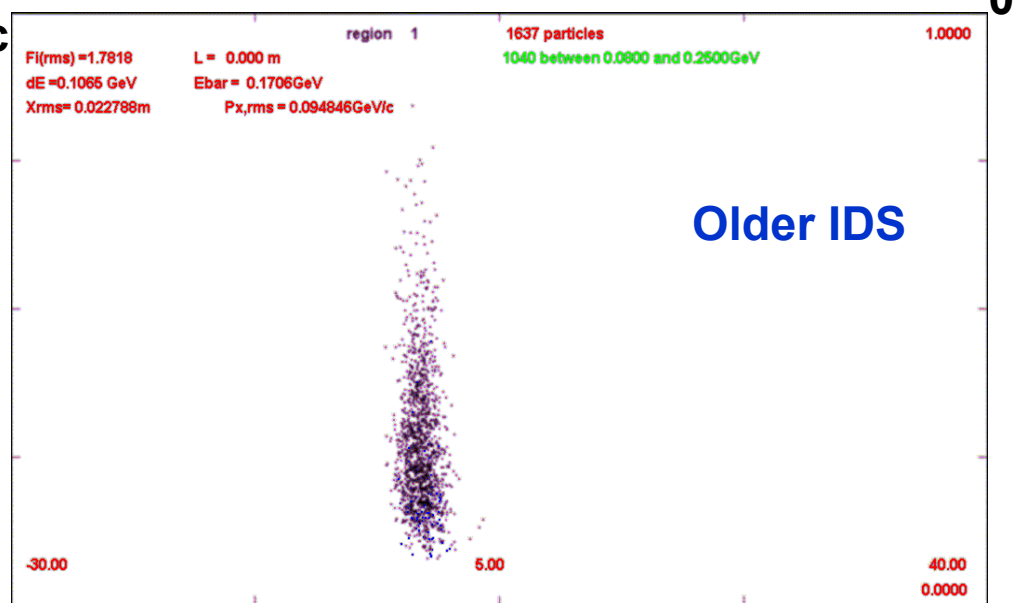
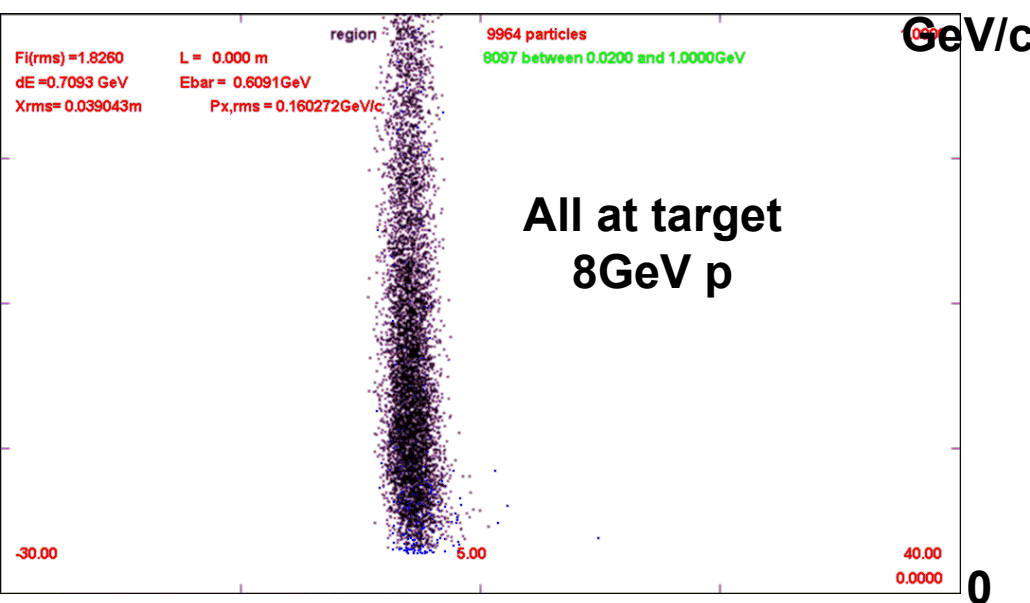
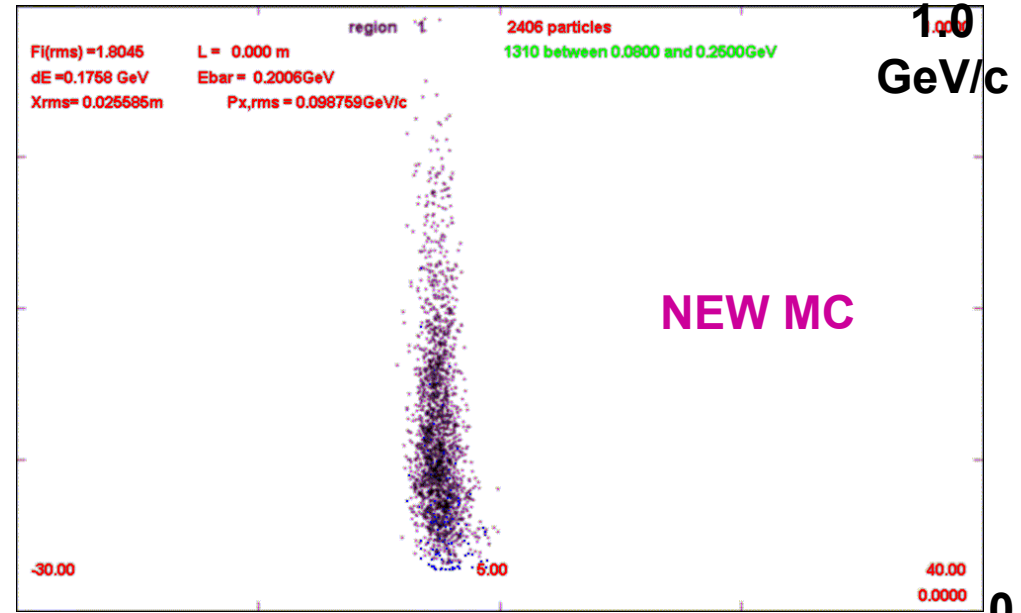

➤ Muon Collider version is an incremental change from IDS

- ~25% shorter
- Higher gradients
 - 9/12/15 → 15/16/18
 - →16/18/20 ?
- Capture at ~275MeV/c rather than 230MeV/c

➤ Collider optimum might be a further increment along ... ?

➤ Optimization should include initial cooling with 6-D

- Used only transverse in present study, LiH absorbers (~1.2cm)

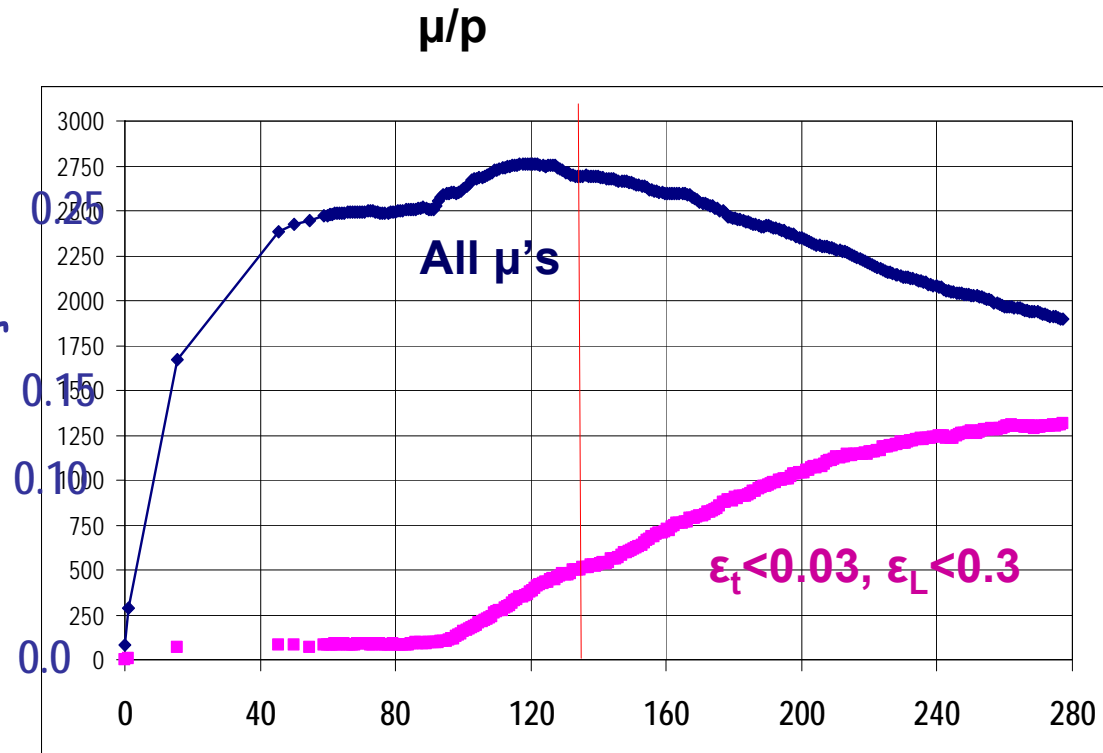

- Should central capture momentum be increased
 - 210 → 230 → 270?
- Would start cooling at higher momentum
 - Longer channel for cooling
- Might want to increase acceptance

