



2008 Neutrino Factory and Muon Collider Collaboration Meeting

MARS15 Simulations of the MERIT Mercury Target Experiment

Sergei Striganov

Fermilab

Fermilab

March 18, 2008

OUTLINE

- ❖ Introduction
- ❖ Geometry & beam description
- ❖ Activation, doses, fluxes
- ❖ Energy deposition in detectors
- ❖ Energy deposition in target

MERIT experiment

The MERIT experiment, to be run at CERN in 2007, is a proof-of-principle test for a target system that converts a 4-MW proton beam into a high-intensity muon beam for either a neutrino factory complex or a muon collider. The target system is based on a free mercury jet that intercepts an intense proton beam inside a 15-T solenoidal magnetic. The Hg jet delivery system will generate a 1-cm diameter mercury stream with velocities up to 20 m/s.

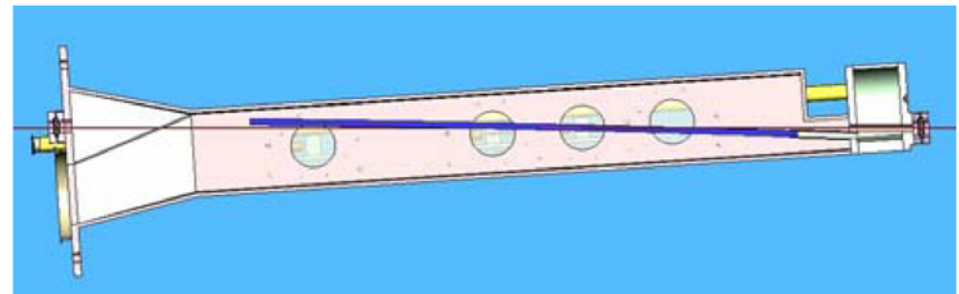
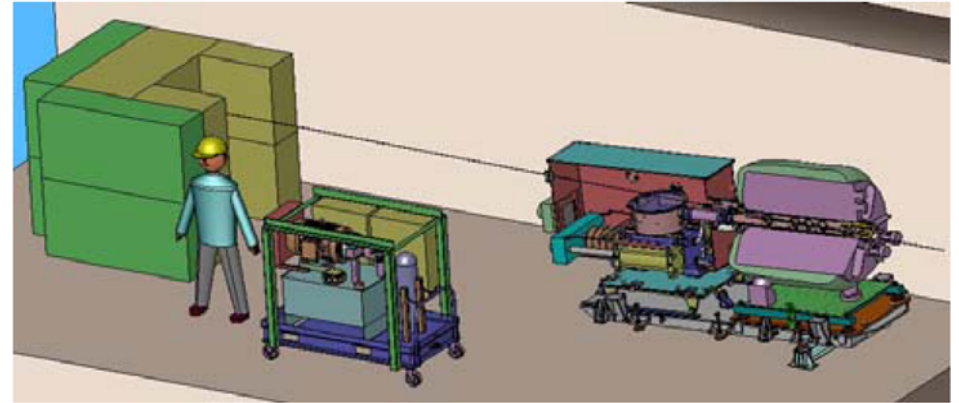

MARS code

MARS code system is a set of Monte Carlo programs for detailed simulation of hadronic and electromagnetic cascades in an arbitrary geometry of accelerator, detector and spacecraft components with particle energy ranging from a fraction of an electron volt up to 100 TeV. The original version of the MARS code was created by Nikolai Mokhov in 1974 and is developed since then in IHEP (Protvino), SSCL and Fermilab.

MERIT geometry in MARS

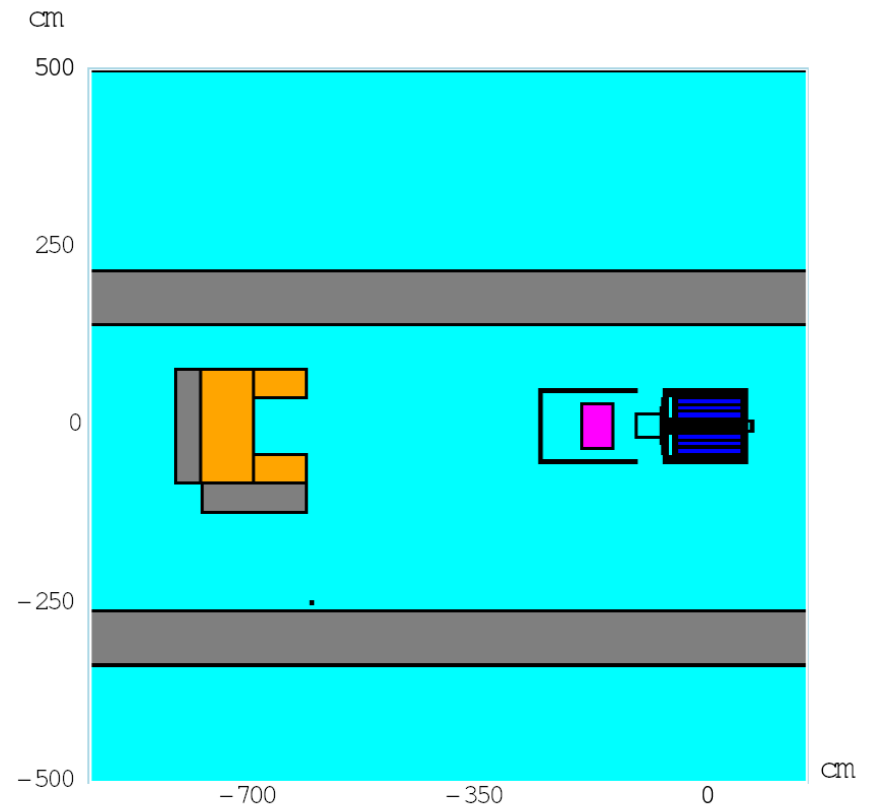
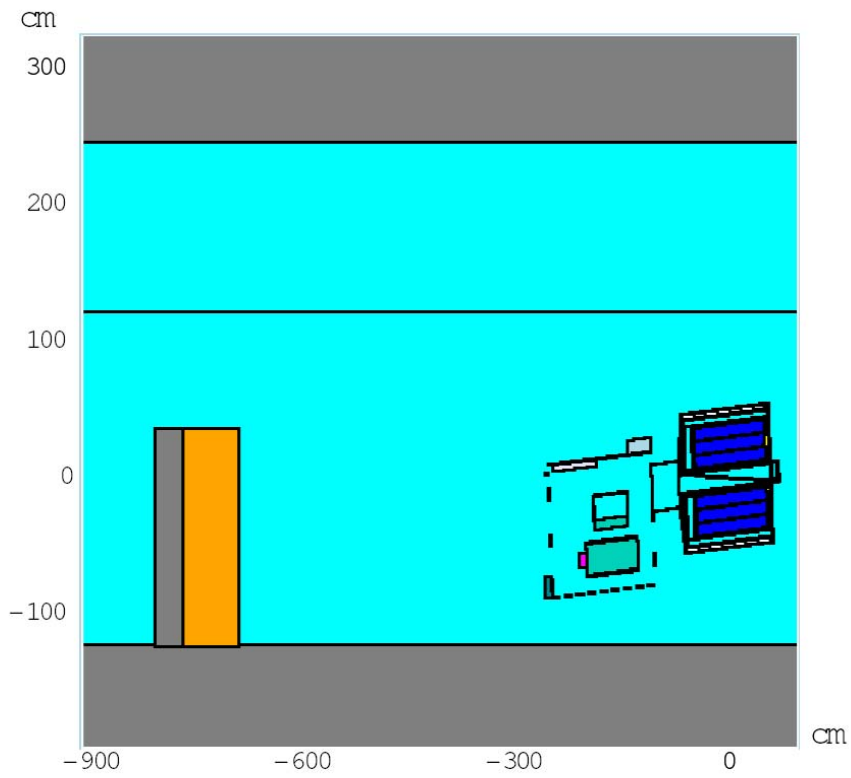

MERIT geometry in MARS

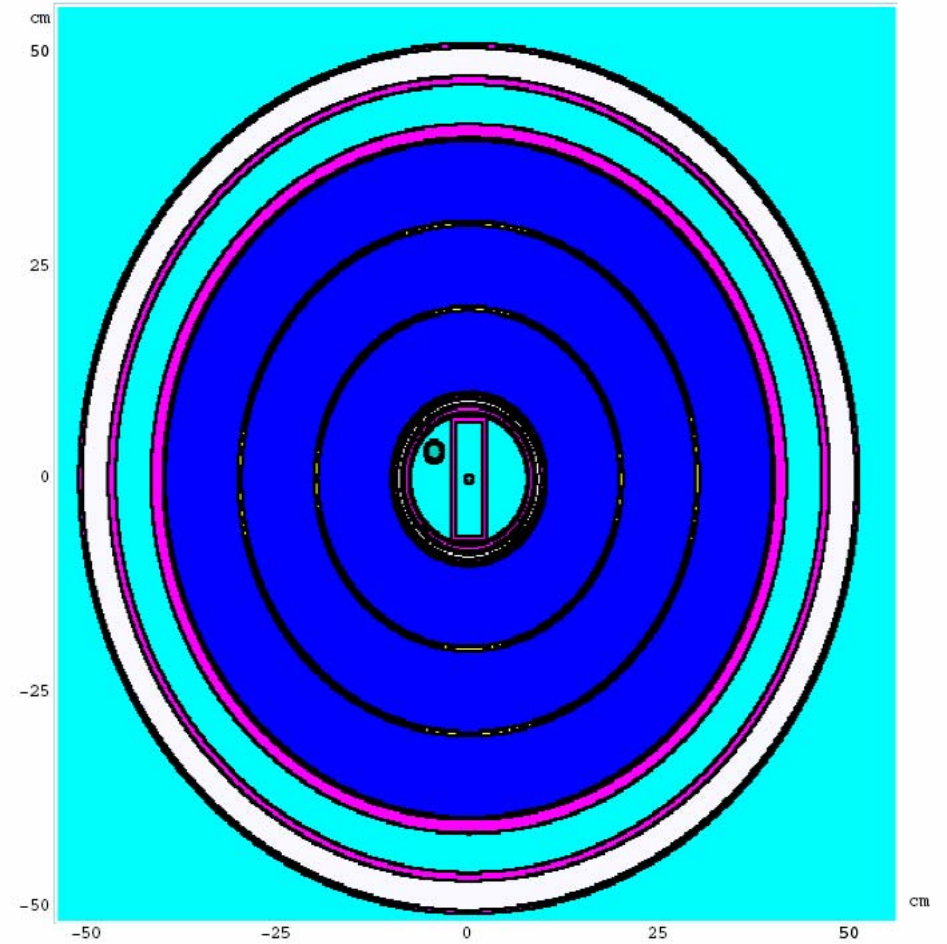
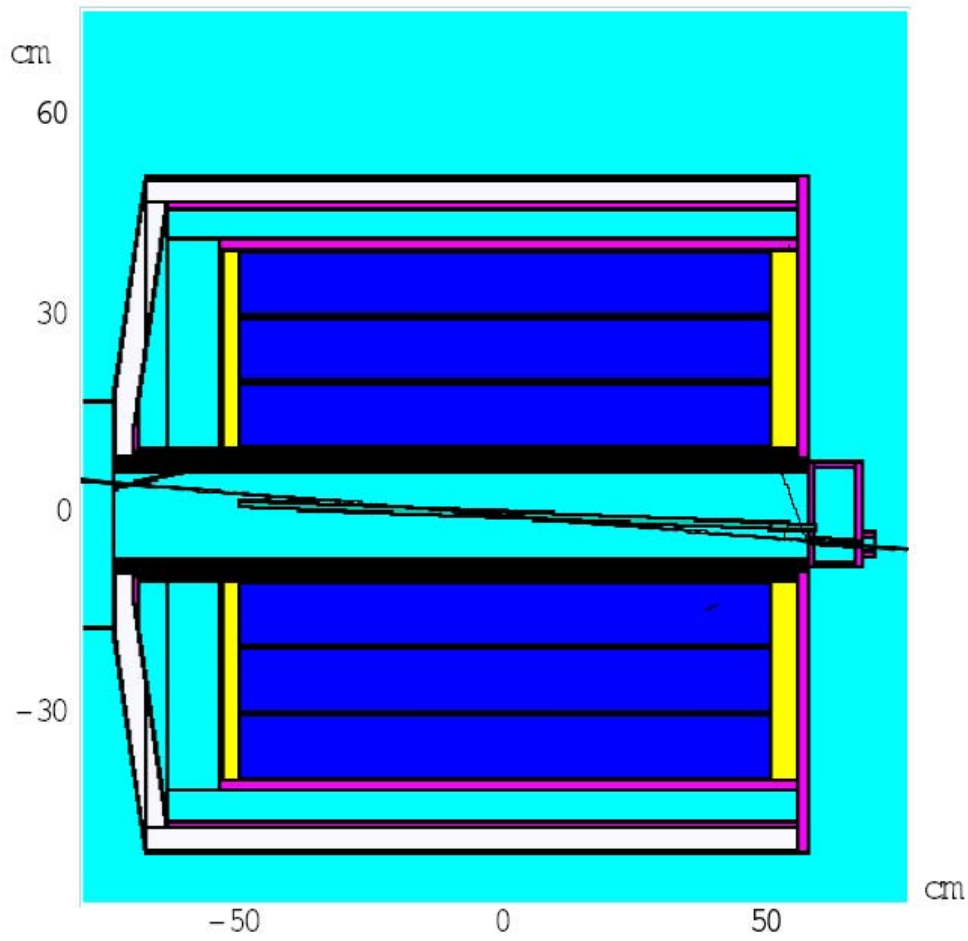

MERIT geometry in MARS

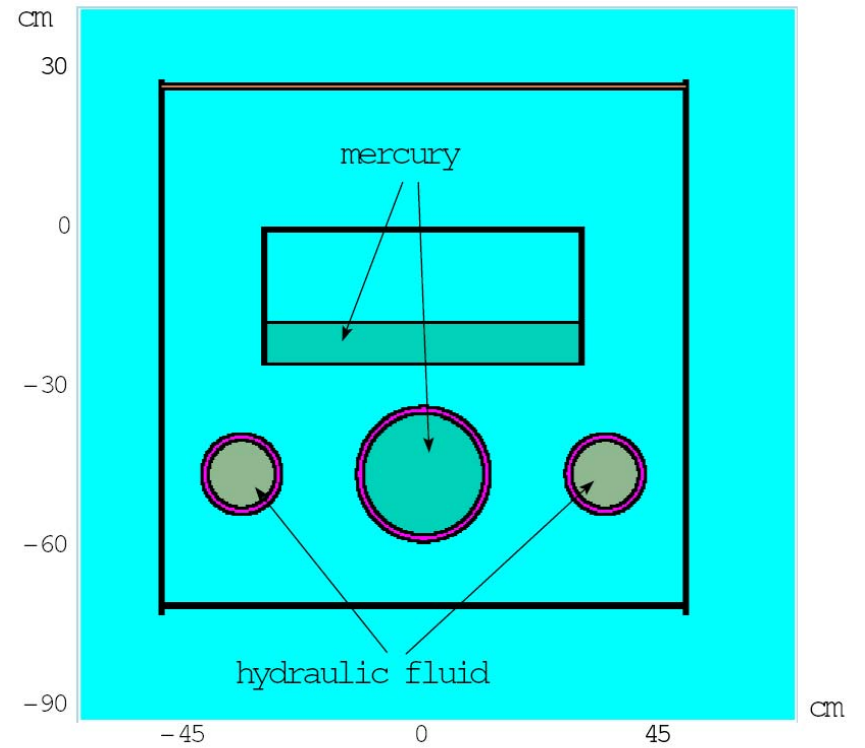
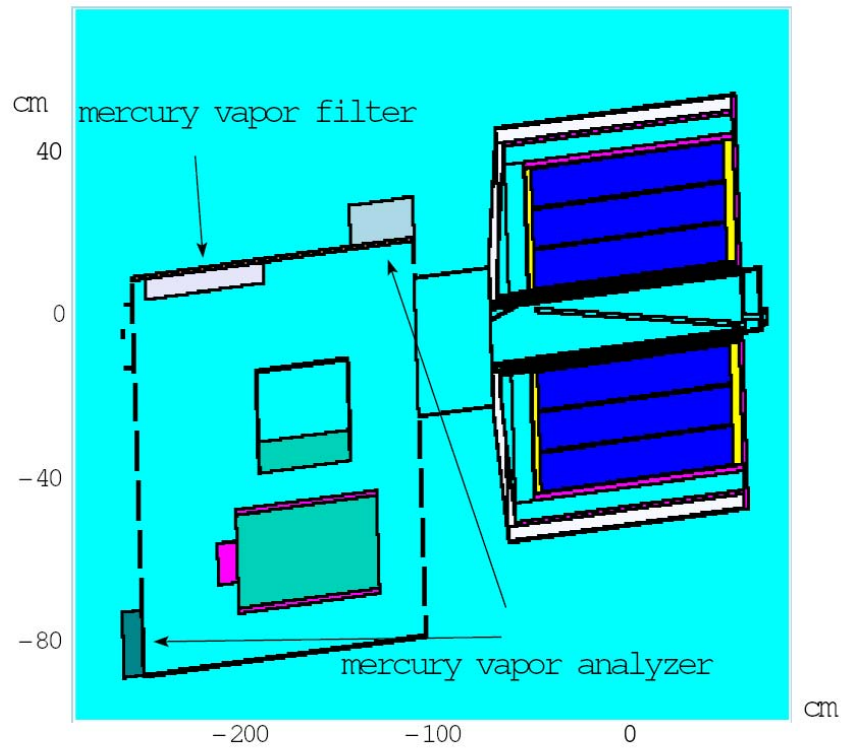

Beam description

Courant-Snyder parameters -
vertical direction:

$$\alpha_v = 0.26$$

$$\beta_v = 279 \text{ cm}$$

$$\sigma_v = 0.117 \text{ cm}$$

Courant-Snyder parameter -
horizontal direction:

$$\alpha_h = 0.53$$

$$\beta_h = 279 \text{ cm}$$

$$\sigma_h = 0.129 \text{ cm}$$

Momentum distribution:

$$\sigma_p = 480 \text{ MeV}/c$$

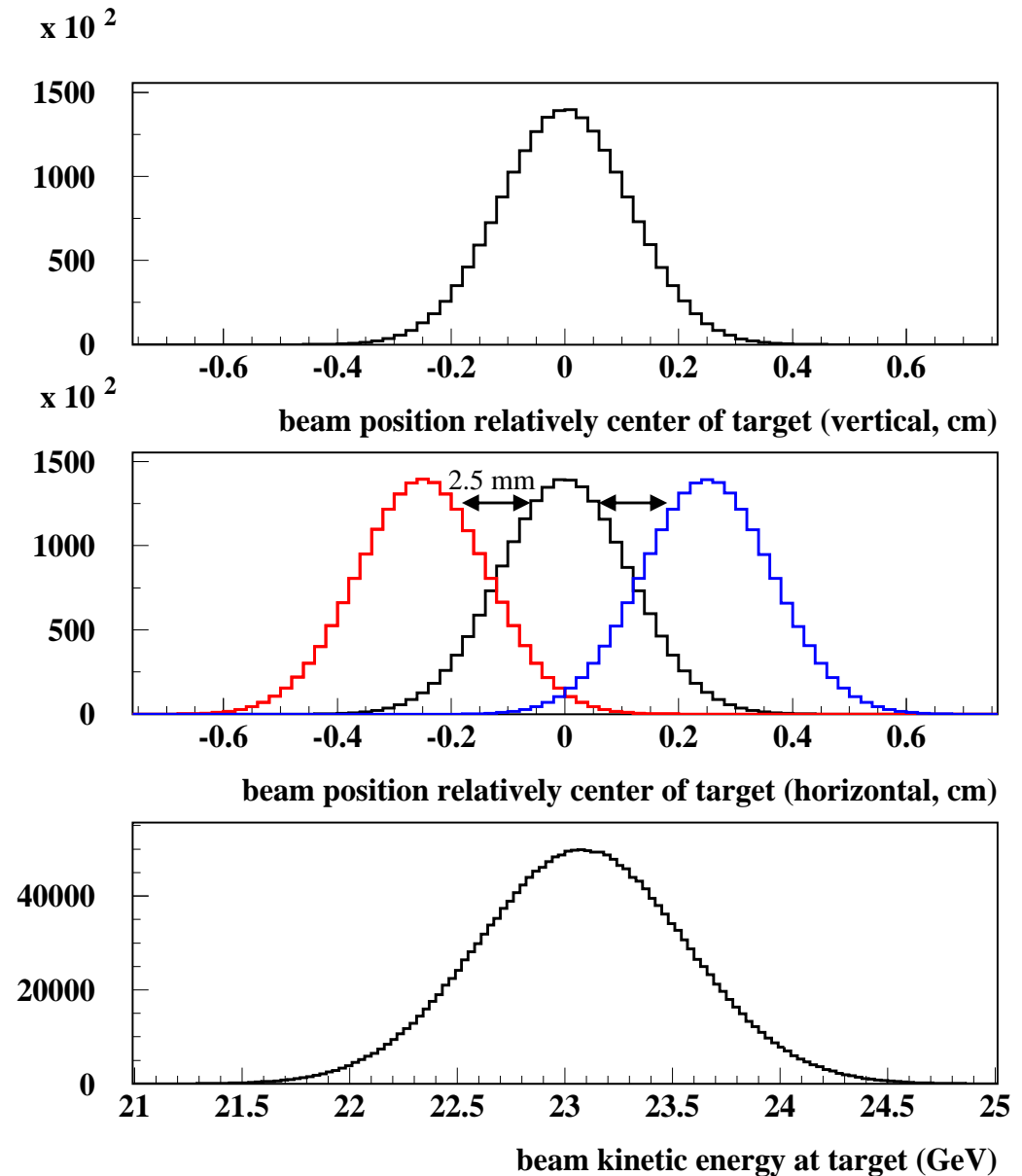

Simulations tasks

Particle fluxes, energy deposition, absorbed doses and residual activities in experimental hall

Absorbed dose and activation of mercury vapor analyzer

Activation of hydraulic fluid

Activation of mercury vapor filter

Secondary particles production

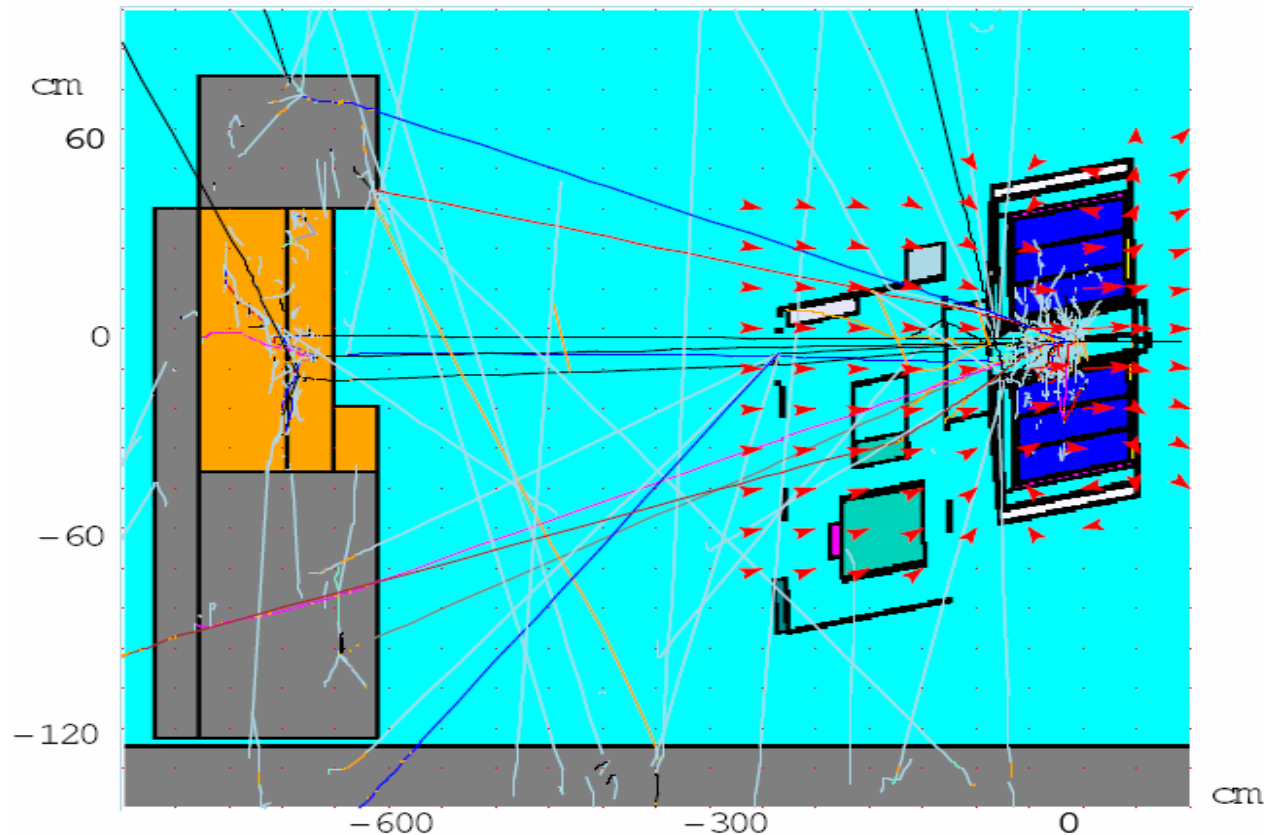

Absorbed dose in Gy per 3×10^{15} protons

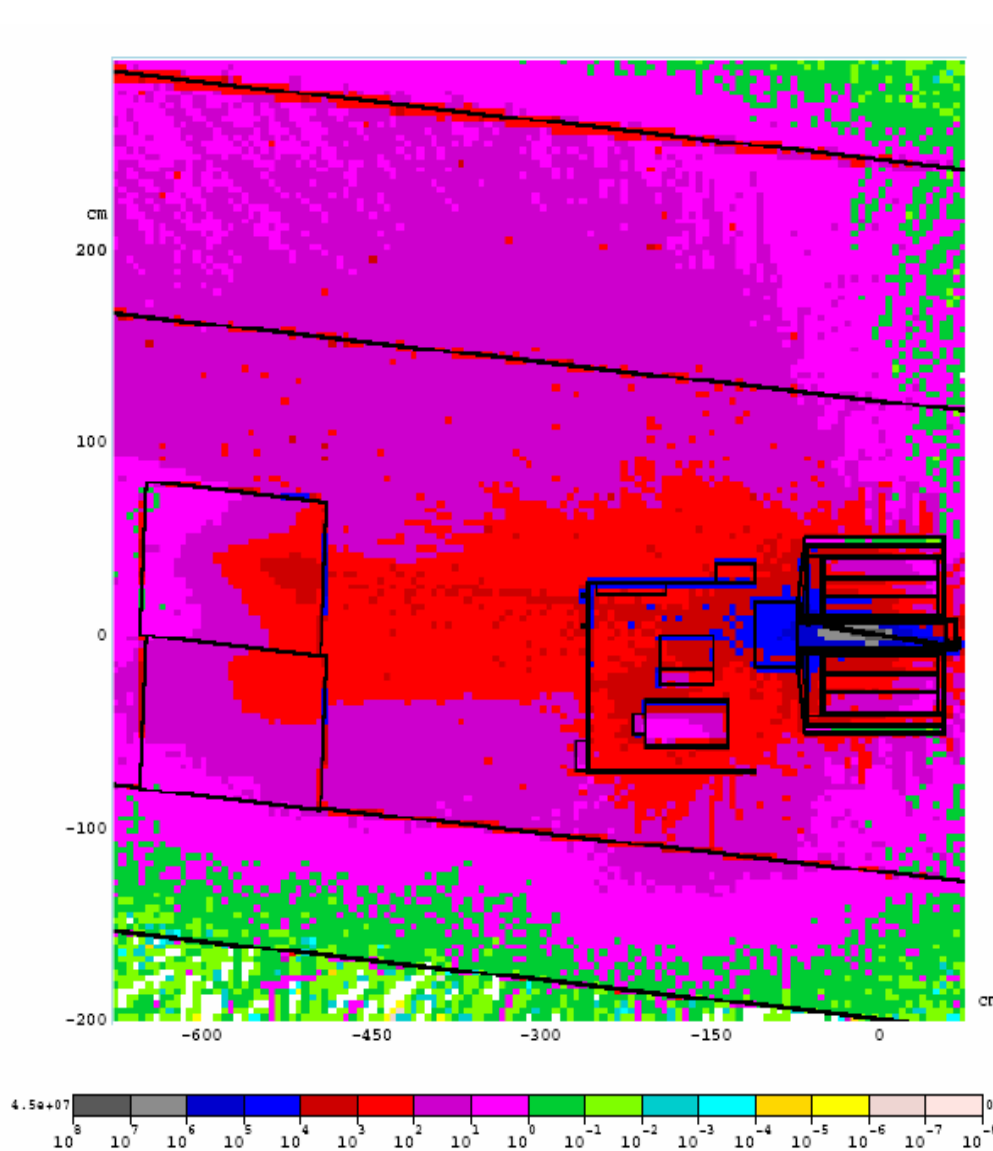

Acceptable level for electronic devices

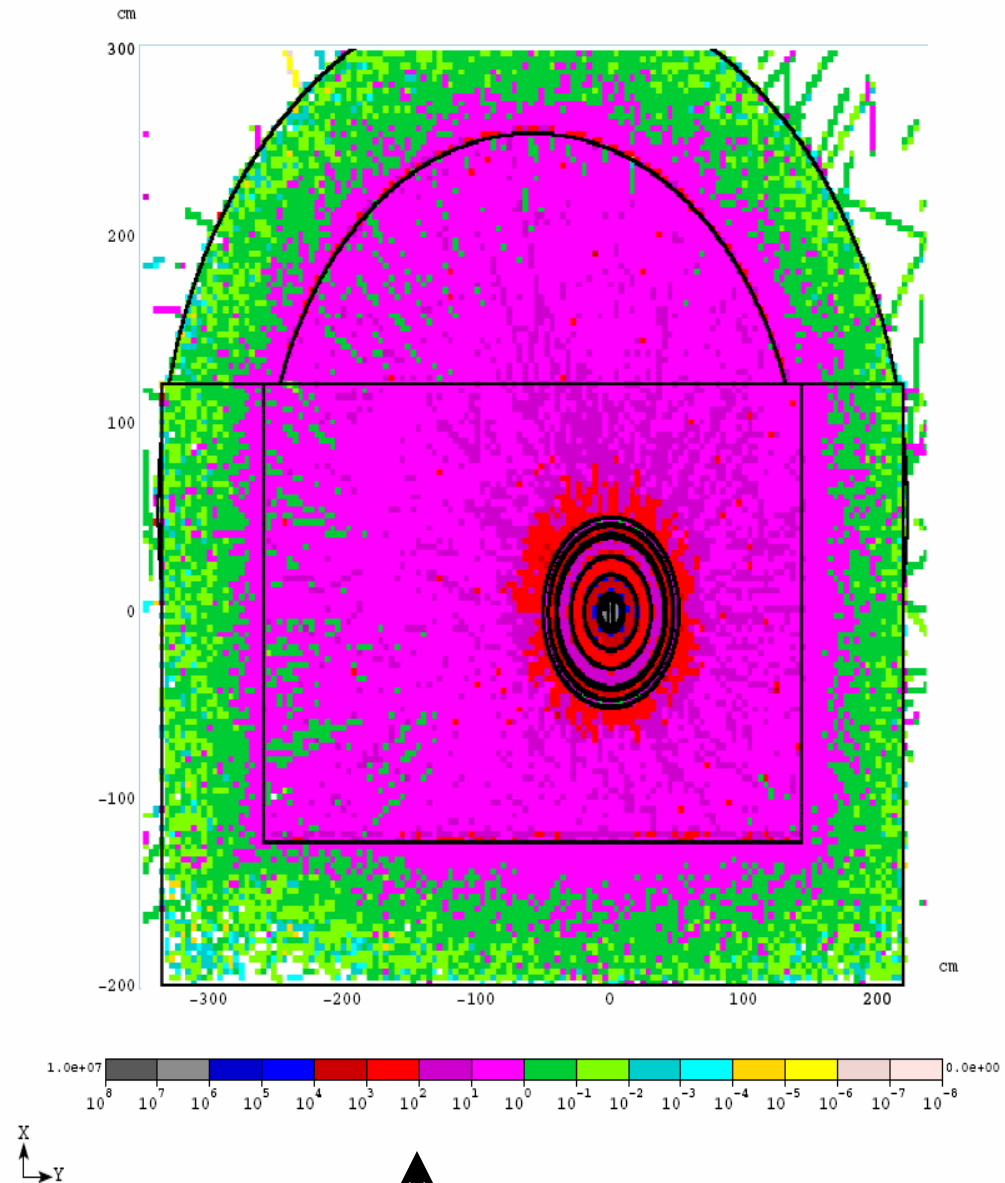

Acceptable level for electronic devices

Radiation levels in detector elements

Residual dose rate on contact after 5 day of irradiation and 1 hour of cooling: mercury vapor analyzer - 0.17 mSv/hr (top), 0.007 mSv/hr (back), hydraulic fluid - 0.021 mSv/hr, mercury vapor filter -0.18 mSv/hr.

Acceptable level is about 1 mSv/hr at FNAL, 0.1(?) mSv/hr at CERN.

Absorbed dose in mercury vapor analyzer is 630 Gy (top) and 14 Gy (back). Acceptable level is 50-100 Gy.

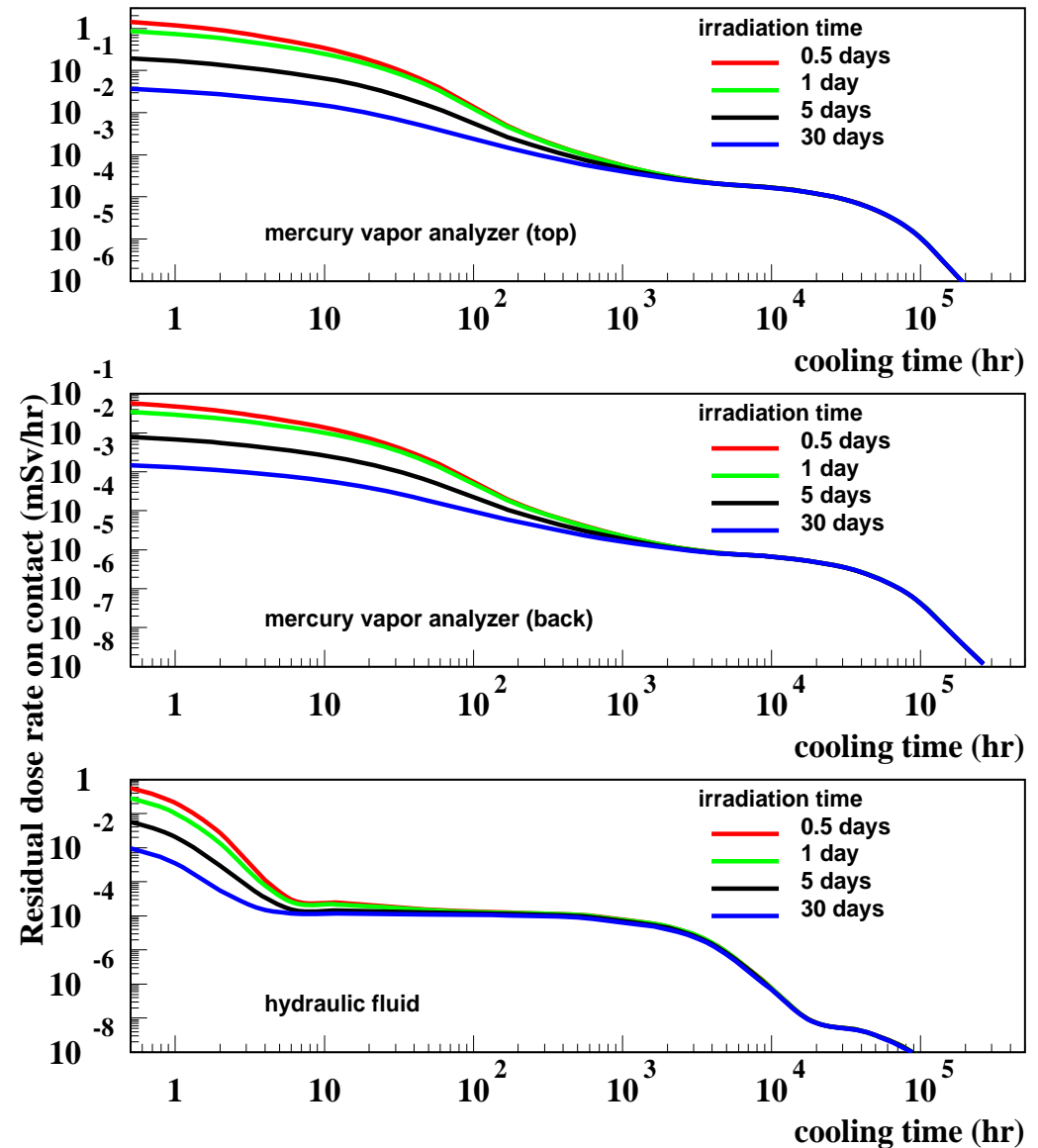

Particle production in MARS at 24 GeV/c

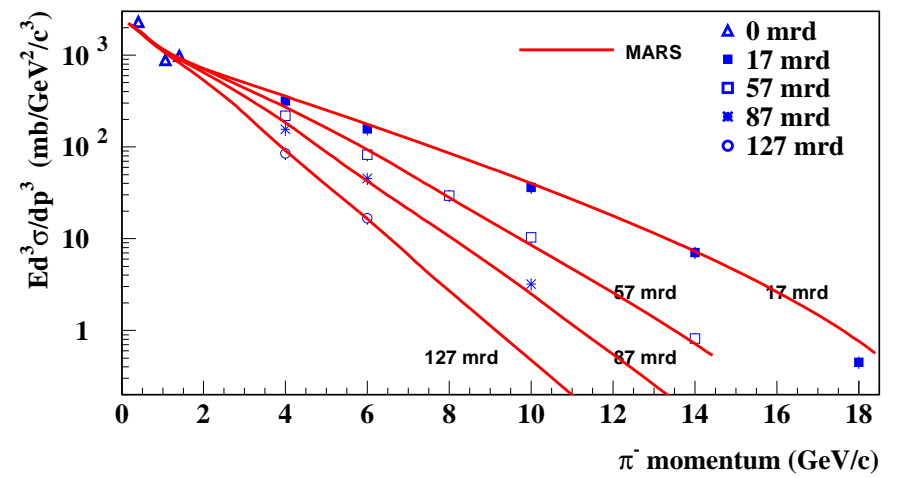
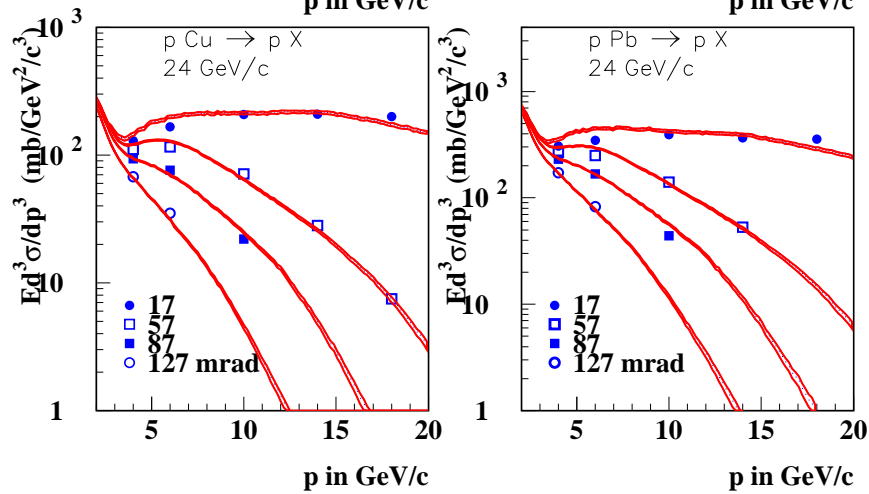
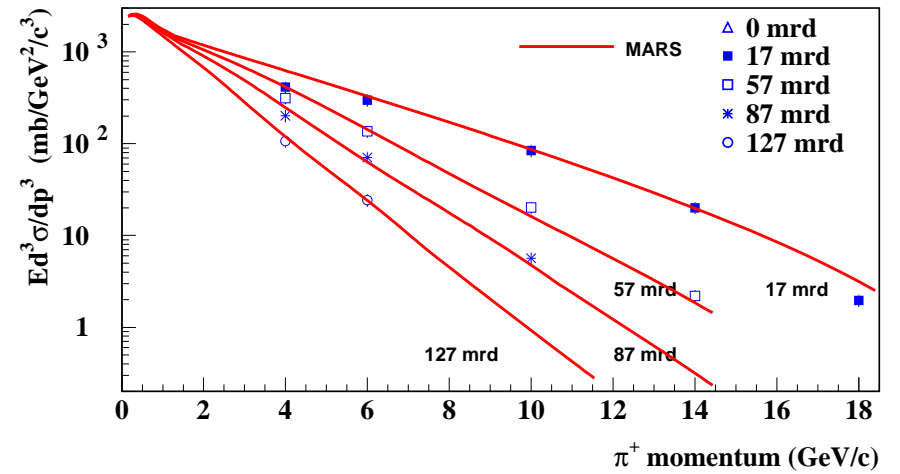
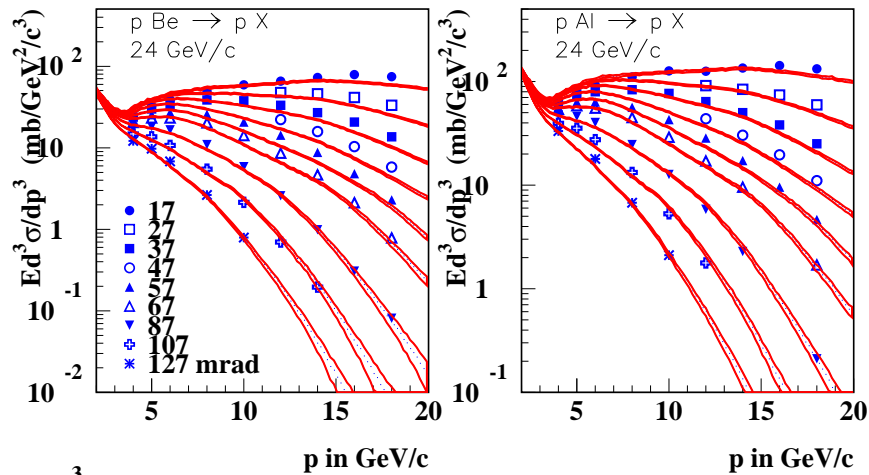

Proton copper interaction at 24 GeV/c

Detector positions and **charged hadron flux** ($1/\text{cm}^2$ per $3 \cdot 10^{13}$ protons on target)

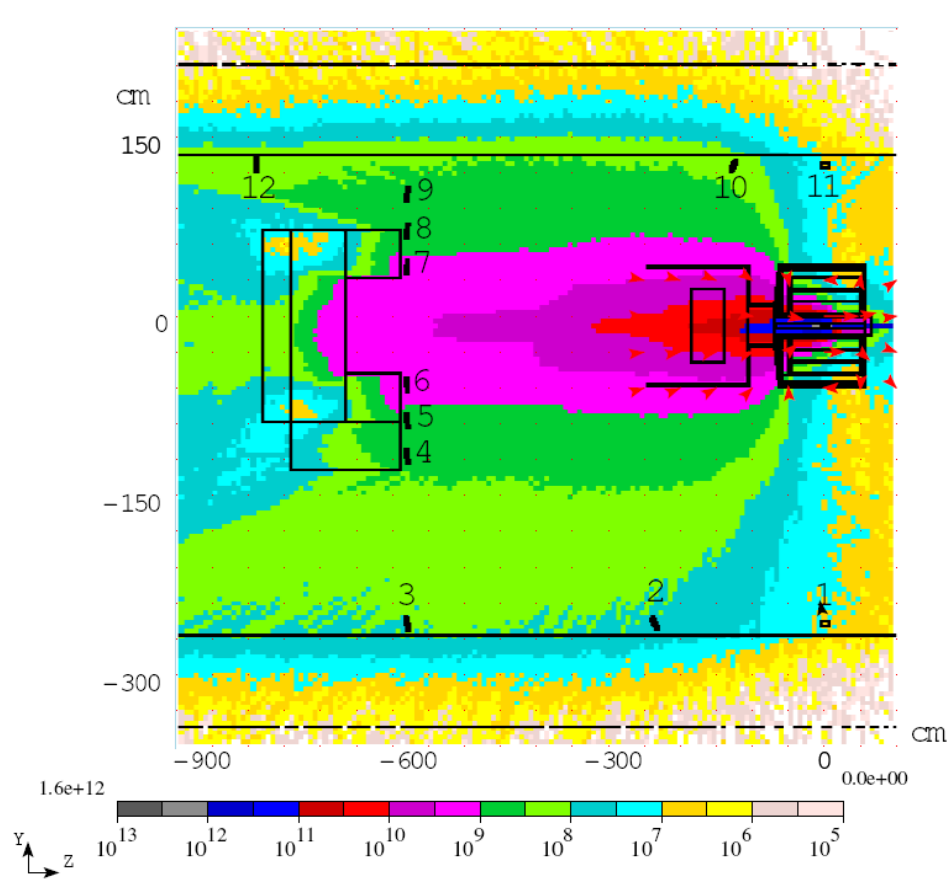

15 Tesla

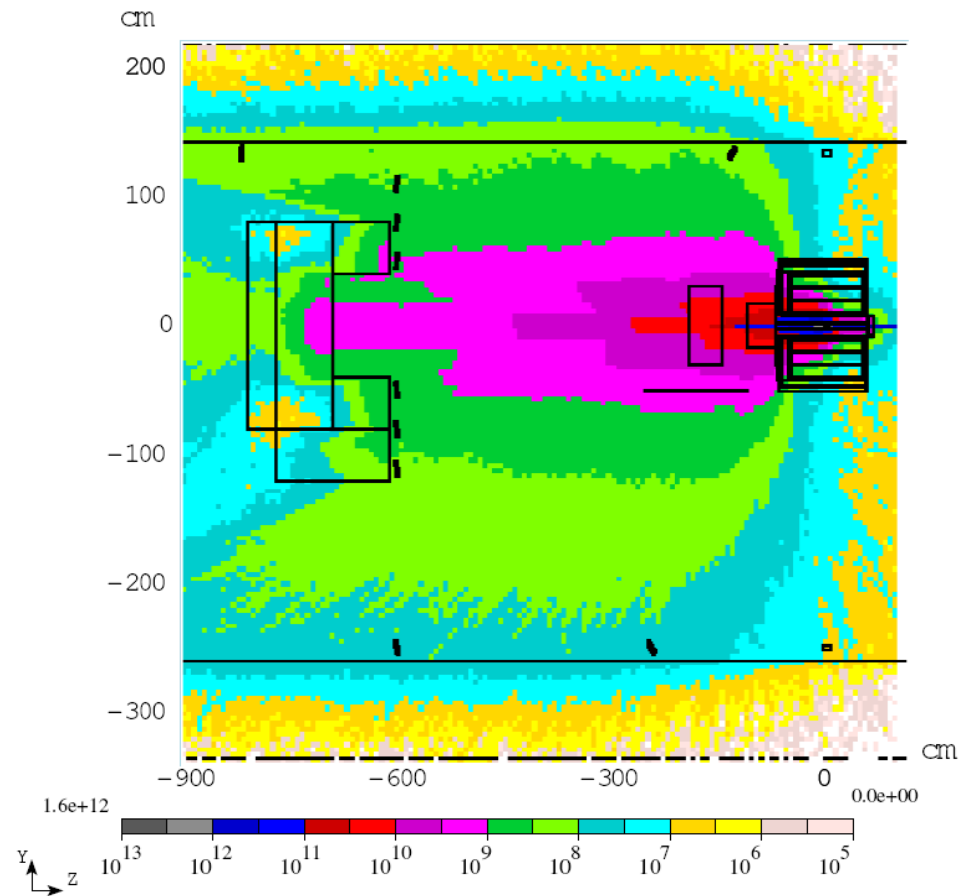

No magnetic field

Detector positions and **charged hadron flux** ($1/\text{cm}^2$ per $3 \cdot 10^{13}$ protons on target)

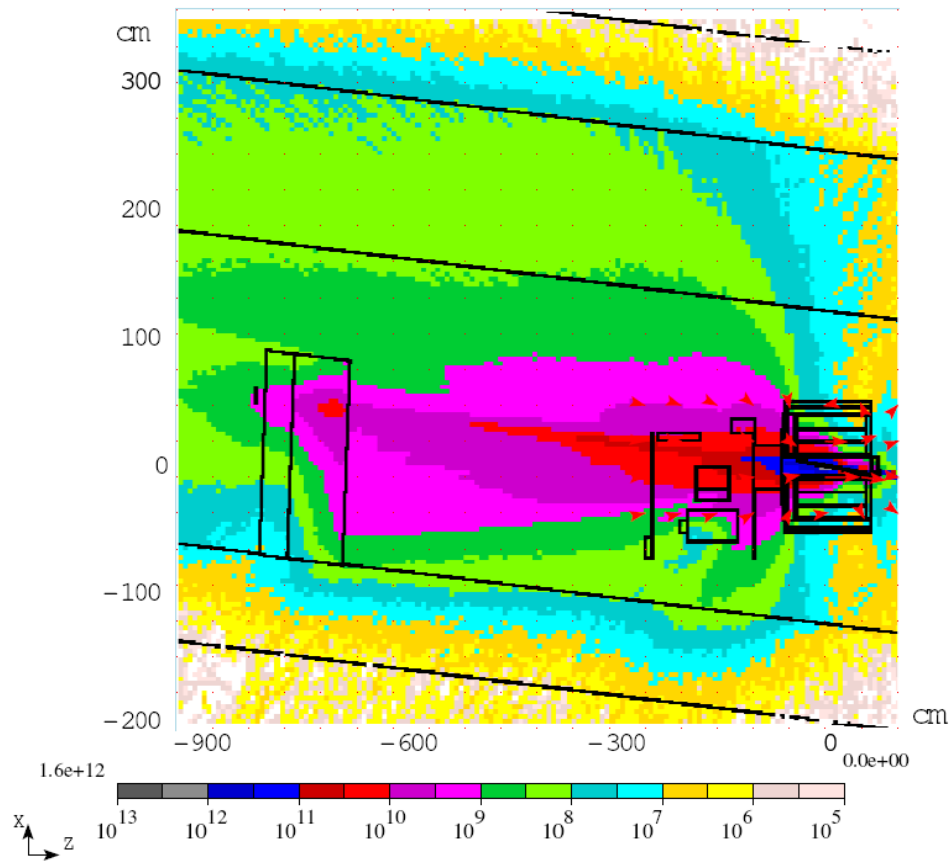

15 Tesla

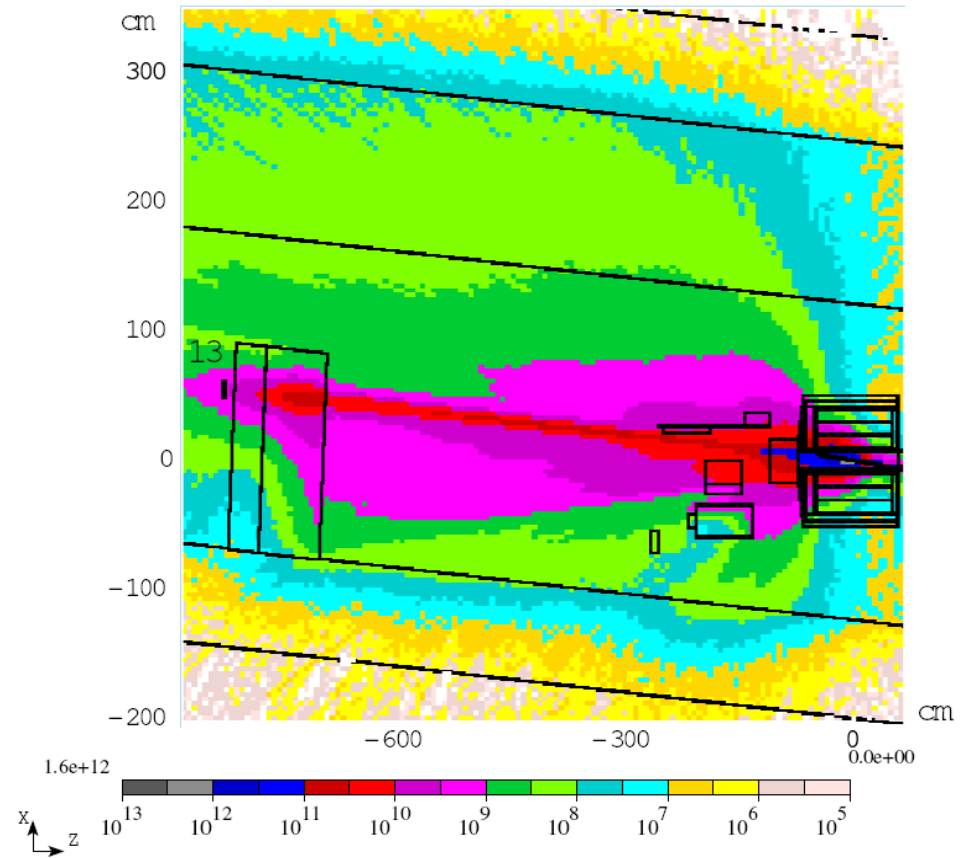

No magnetic field

Electron/positron flux (1/cm² per 3 10¹³ protons on target)

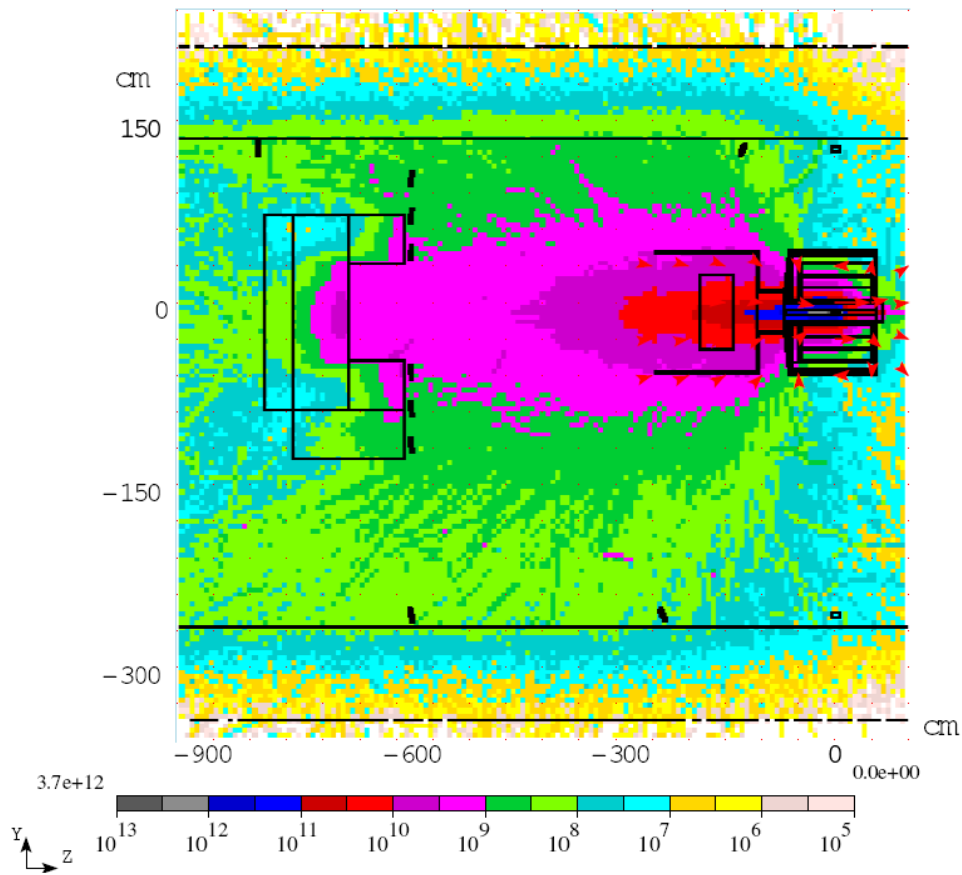

15 Tesla

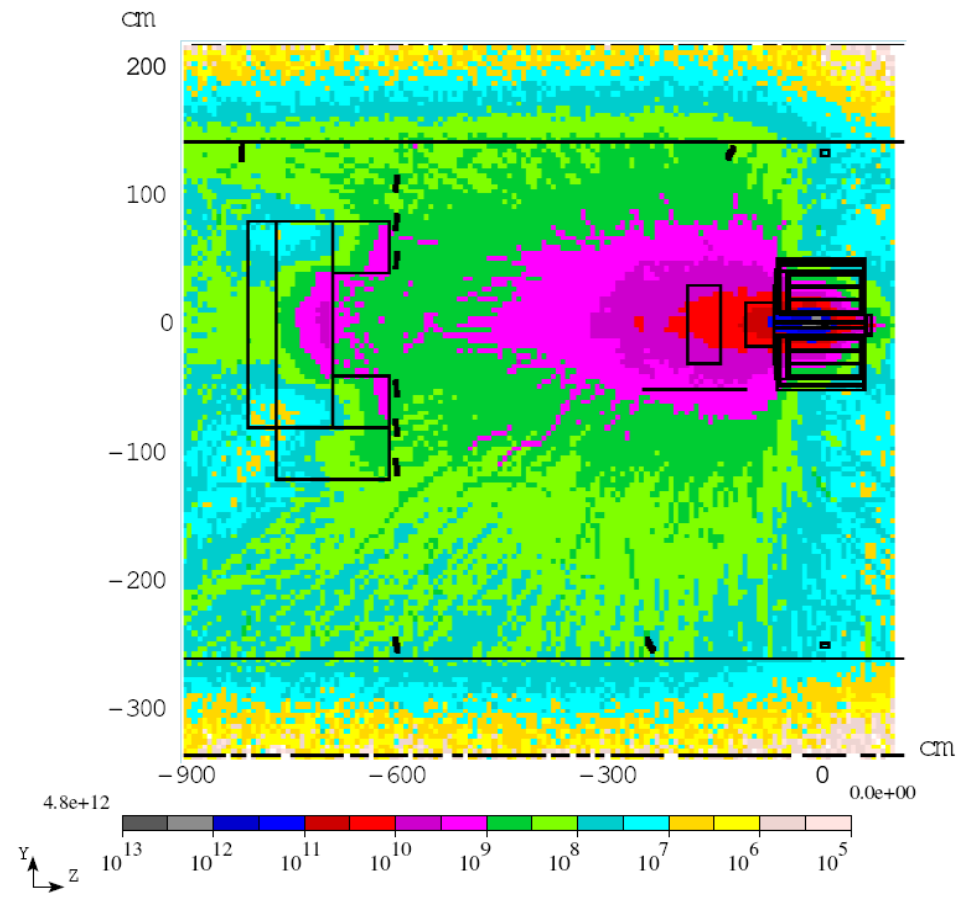

No magnetic field

Gamma flux (1/cm² per 3 10¹³ protons on target)

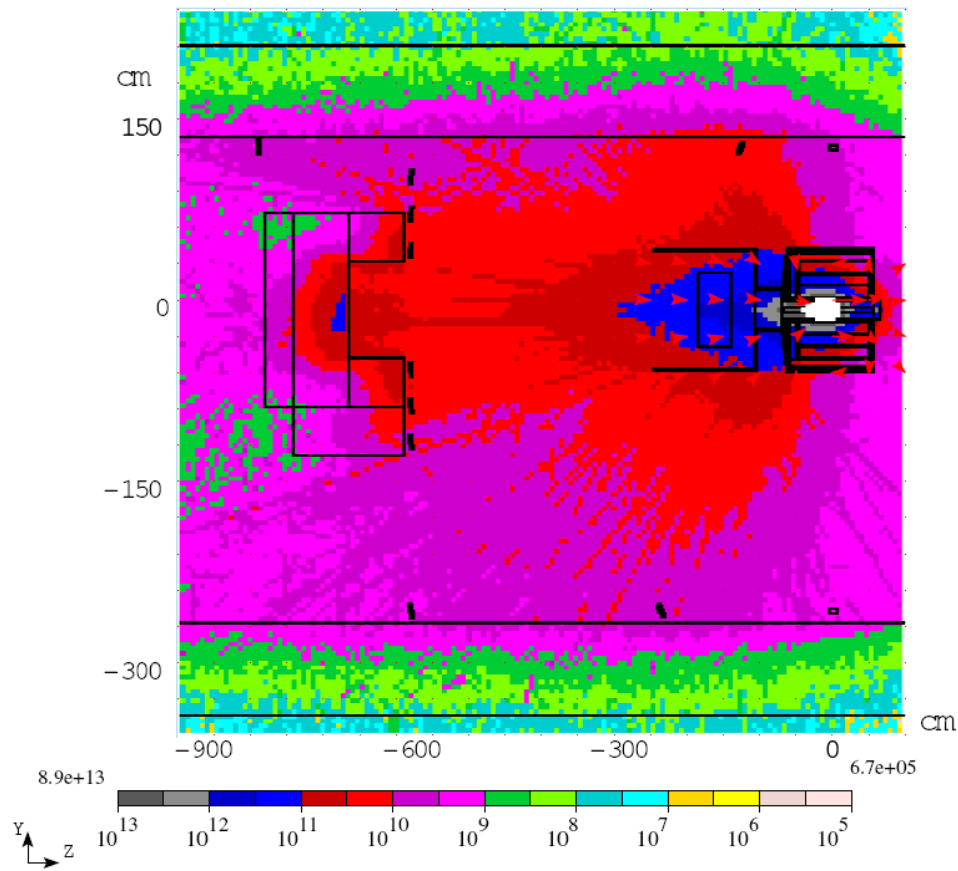

15 Tesla

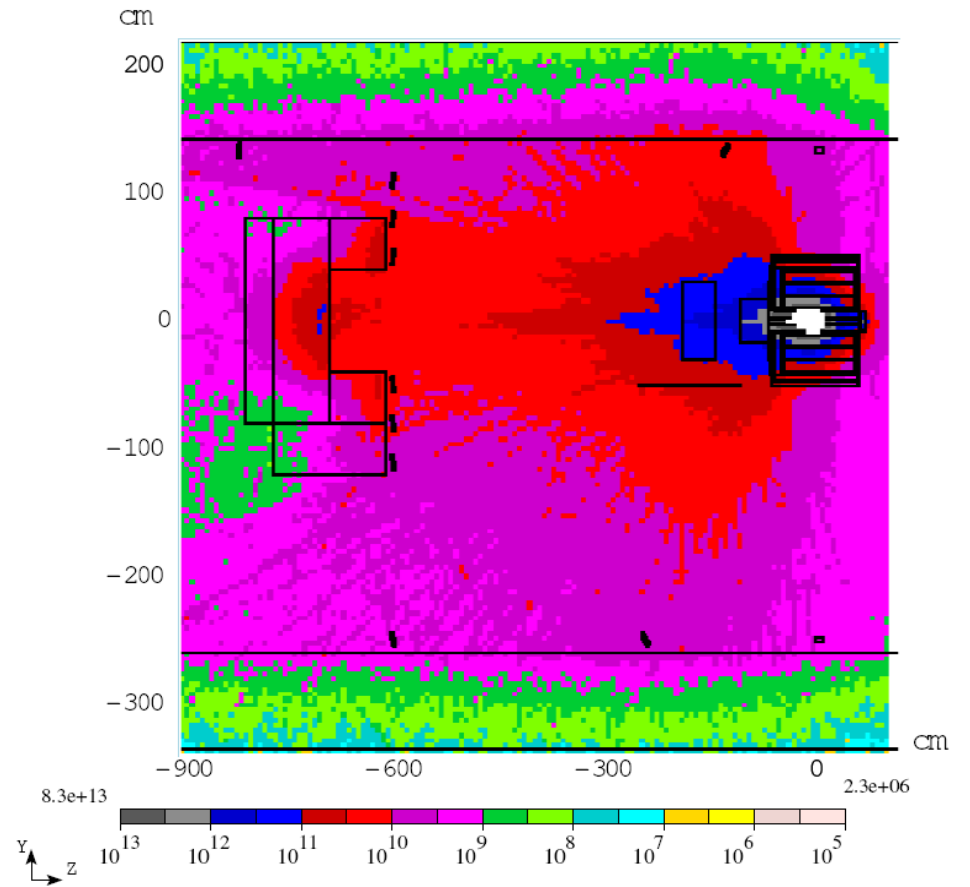

No magnetic field

Energy spectra (12 degree detector). Blue lines - all particles, red lines- particles created in attenuator

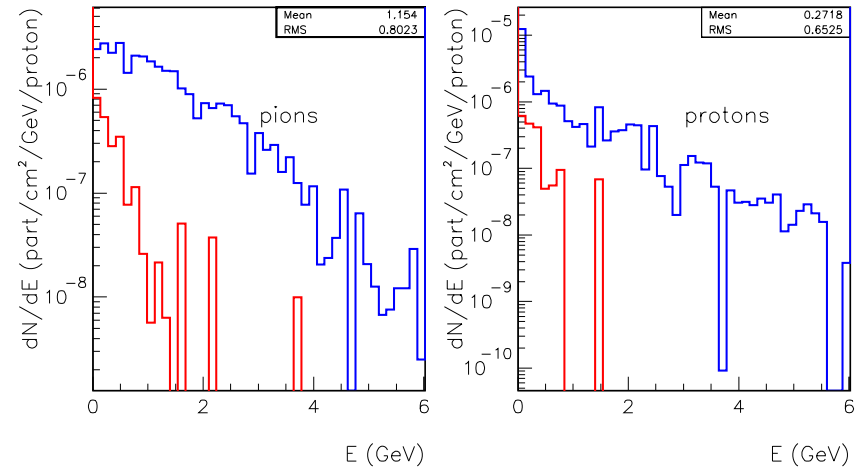
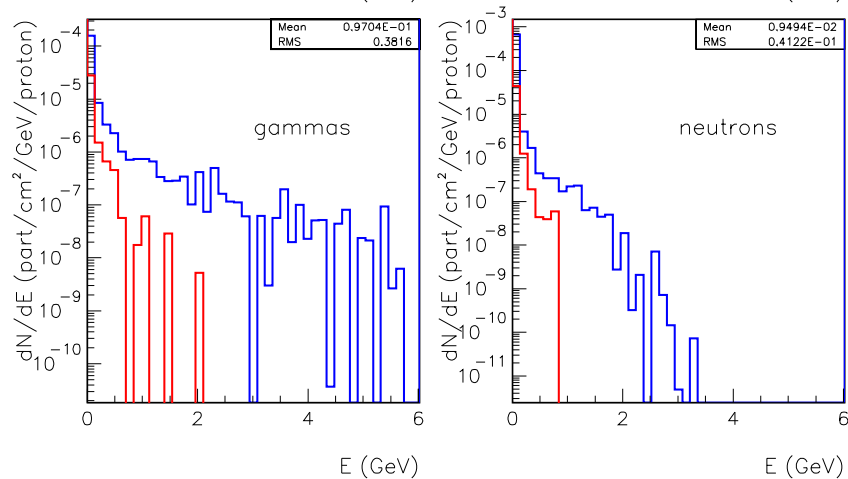
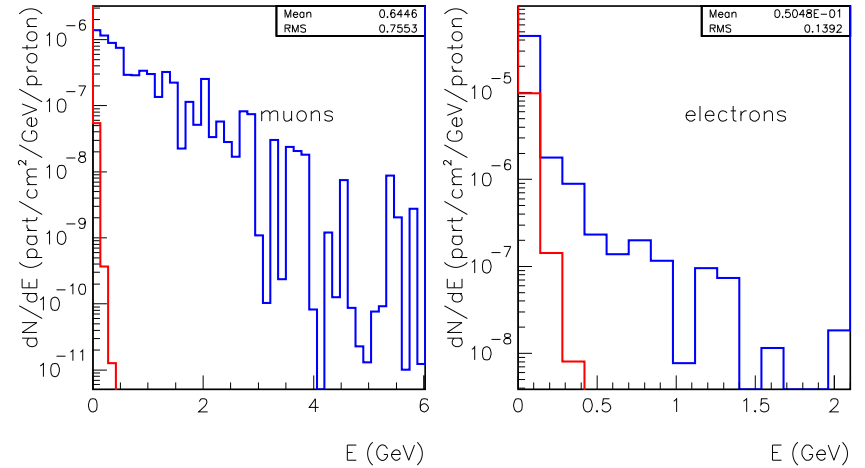
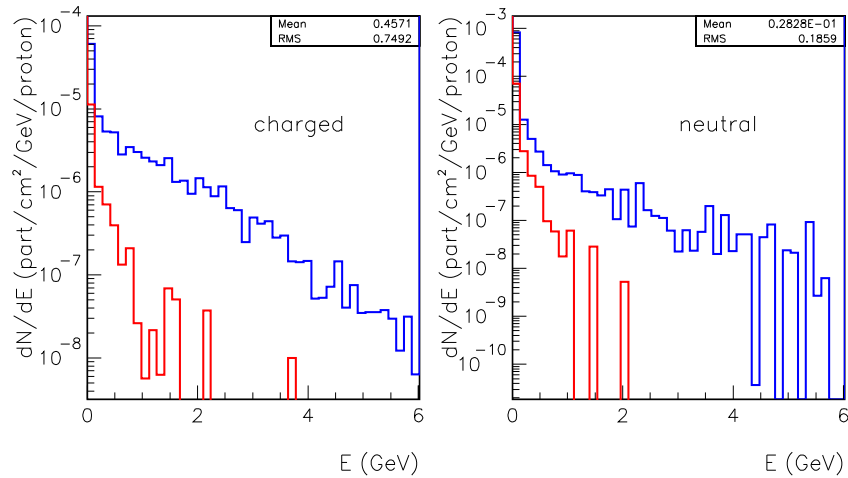

Energy spectra at 12 degree (detector 3)

Energy spectra of charged particles at 12 degree (detector 3)

Time distributions in 12 degree detector

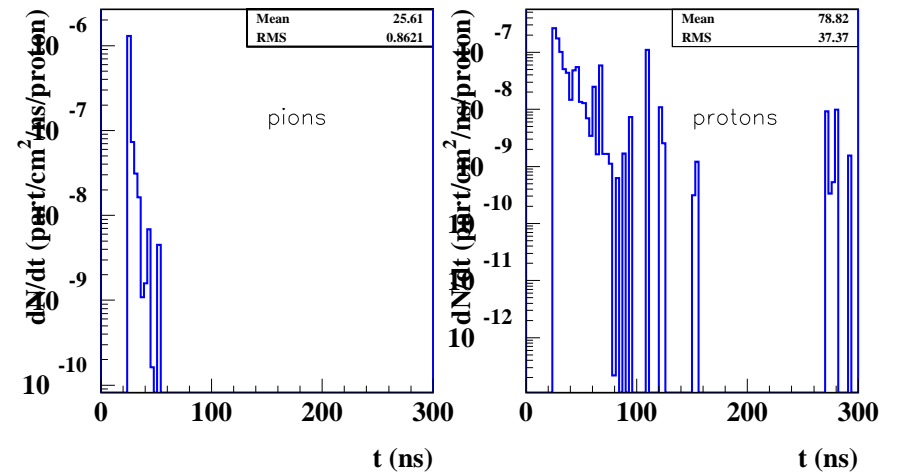
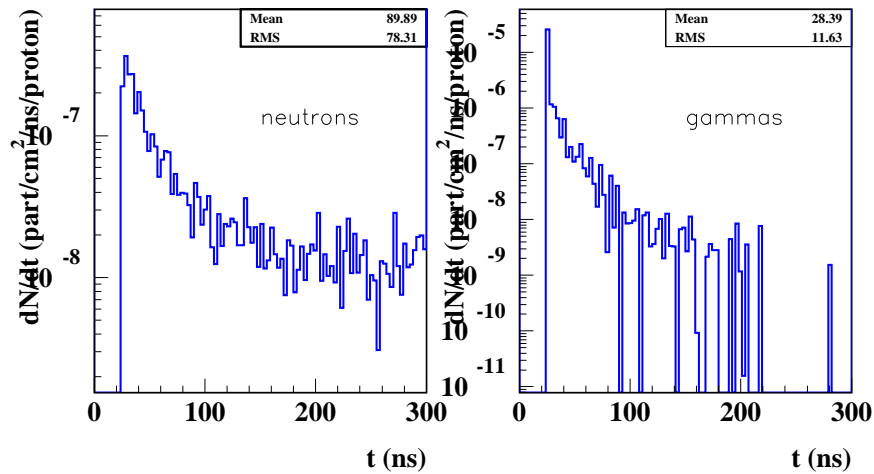
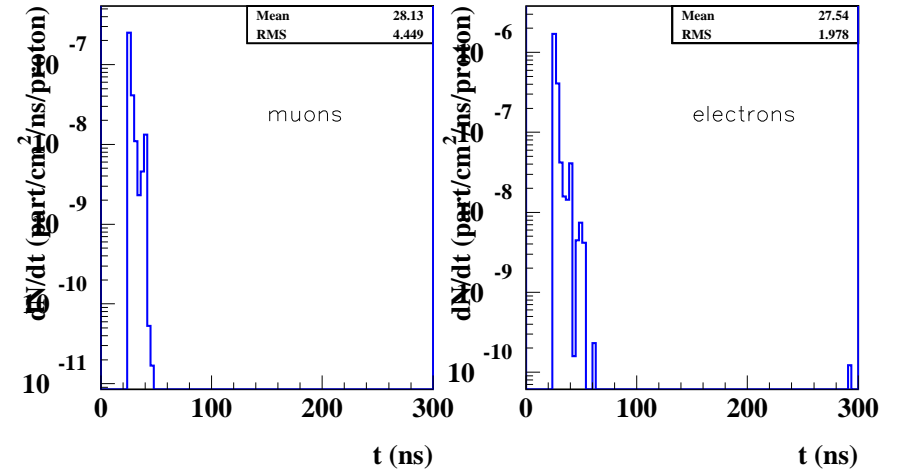
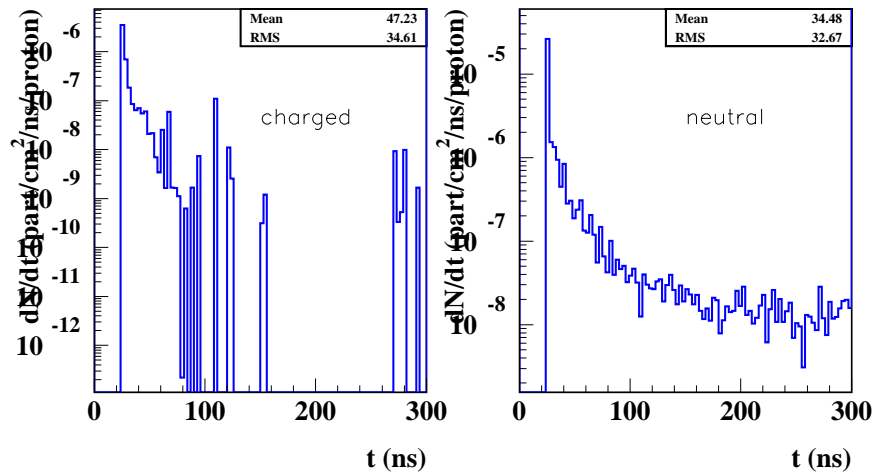

Time distribution at 12 degree (detector 3)

Time distribution of charged particles at 12 degree (detector 3)

Energy depositions in detectors for 15 Tesla field

pCVD diamond detectors were chosen to measure secondary particle production. Charged particles create electron-hole pair in a voltage biased diamond, inducing a current in the circuit. Energy to create one electron-hole pair is about 14 eV. Detector area is 7.5x7.5 mm, thickness - 0.5 mm.

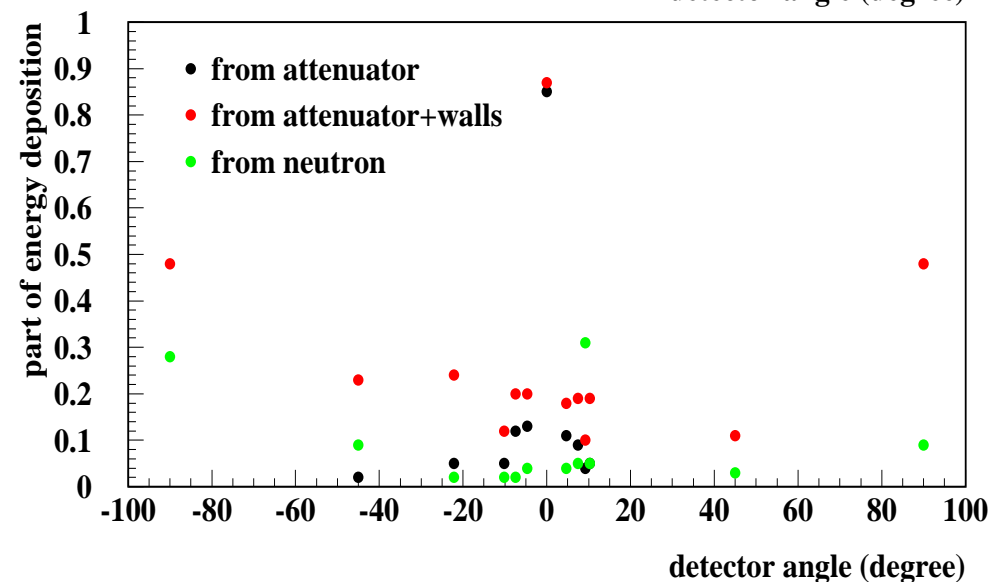
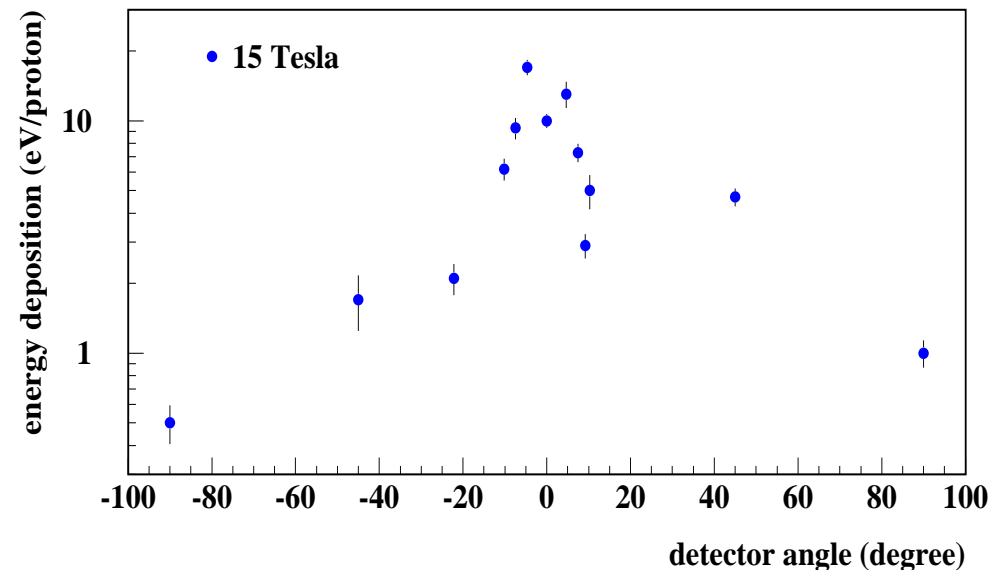

Energy depositions in detectors for different magnetic field in solenoid

- Detector 1: -90 degree
- Detector 2: -45 degree
- Detector 3: -22 degree
- Detector 4: -10 degree
- Detector 5: -7.5 degree
- Detector 6: -4.7 degree
- Detector 7: 4.7 degree
- Detector 8: 7.5 degree
- Detector 9: 10 degree
- Detector 10: 45 degree
- Detector 11: 90 degree
- Detector 12: 9 degree
- Detector 13: 0 degree

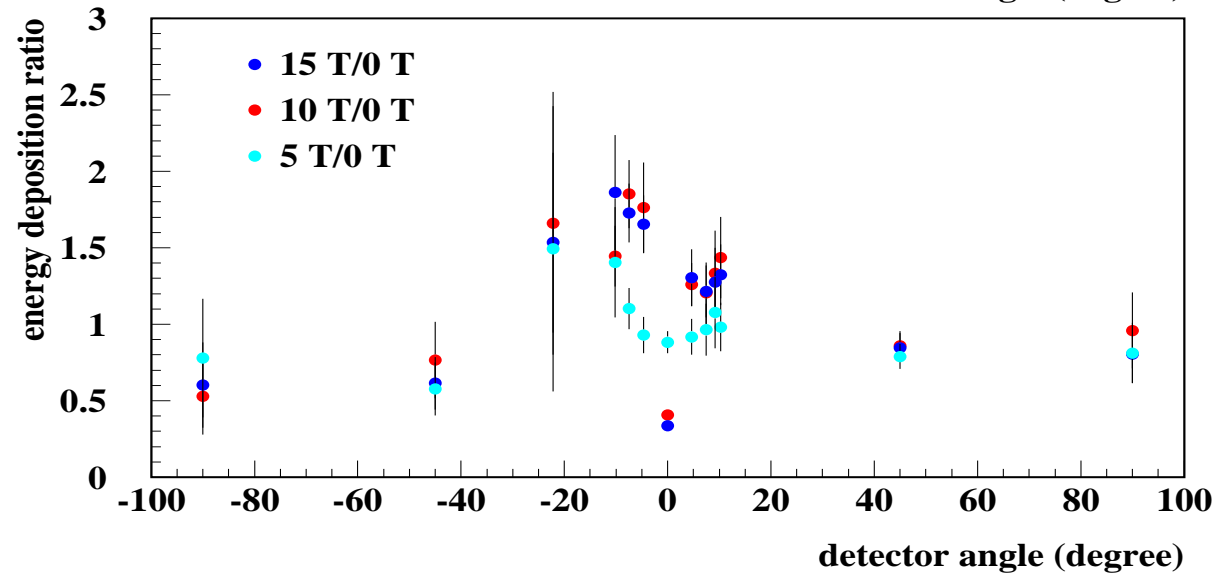
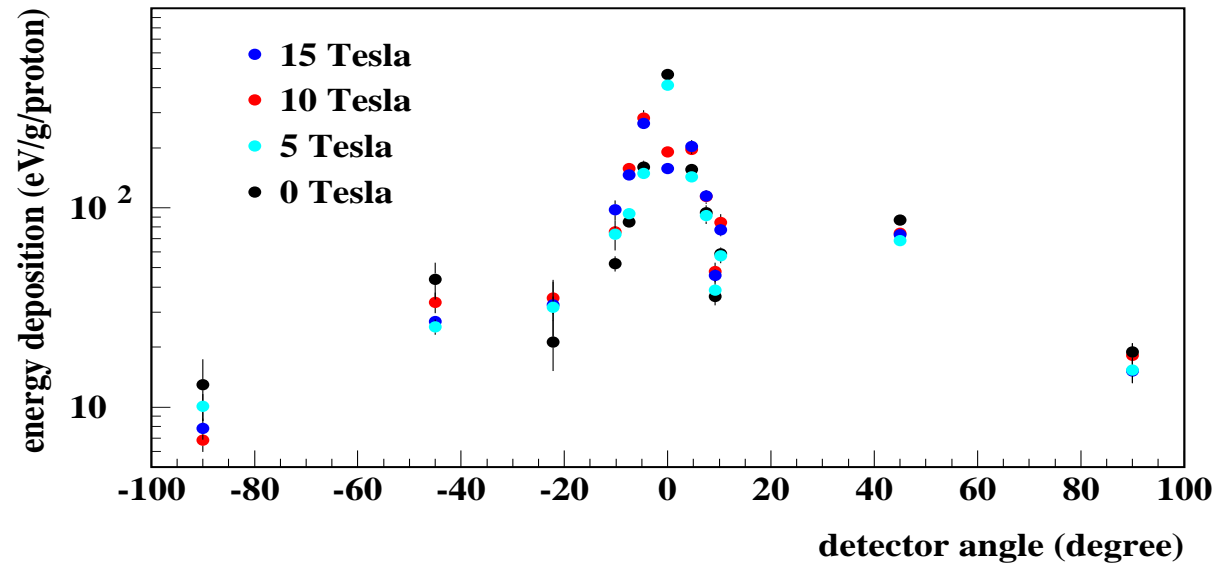

Energy depositions in detectors for different beam position at the target

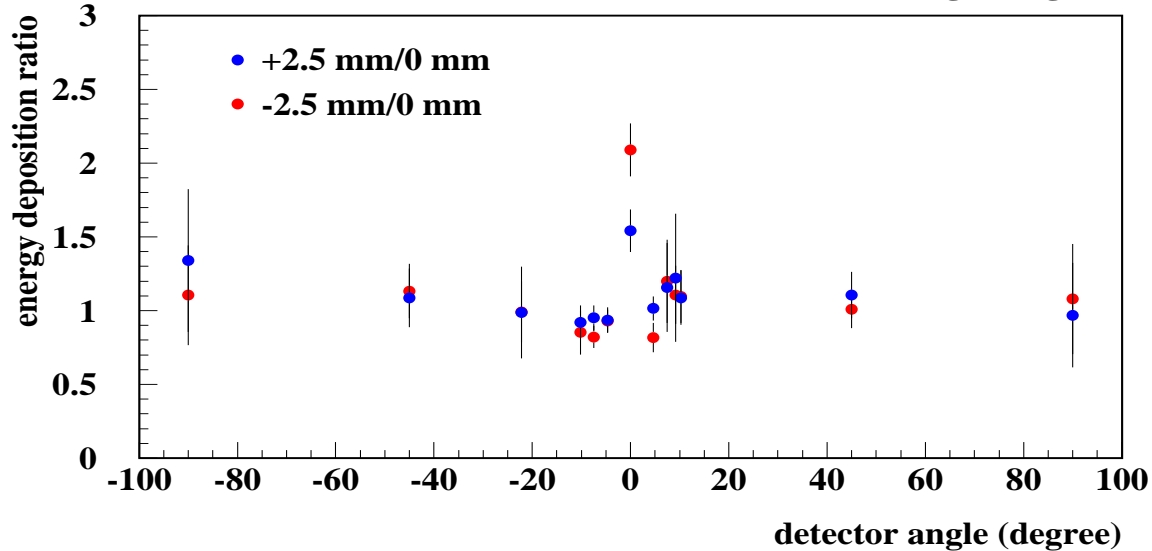
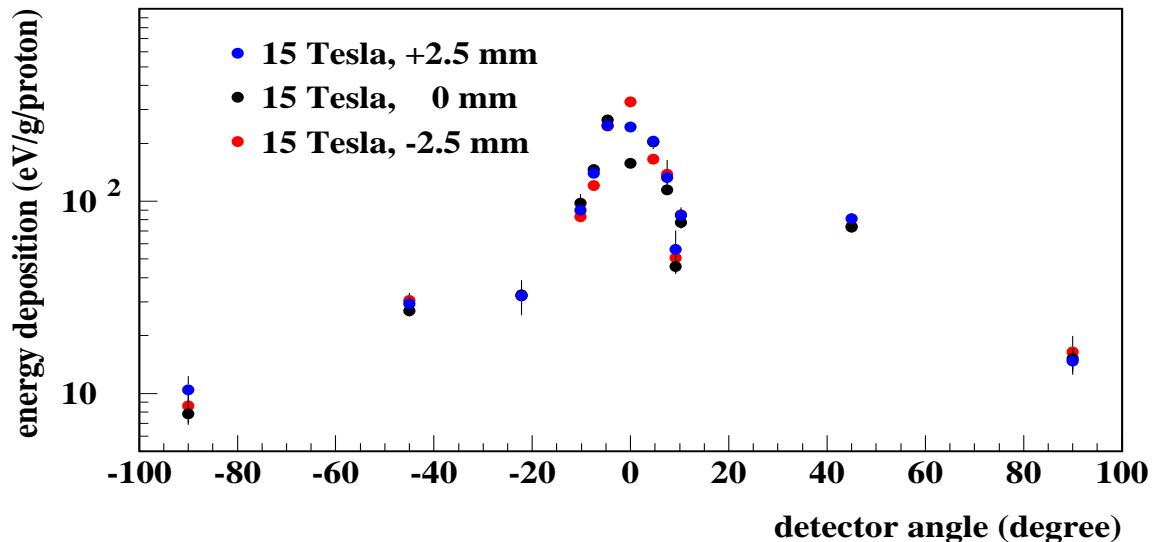
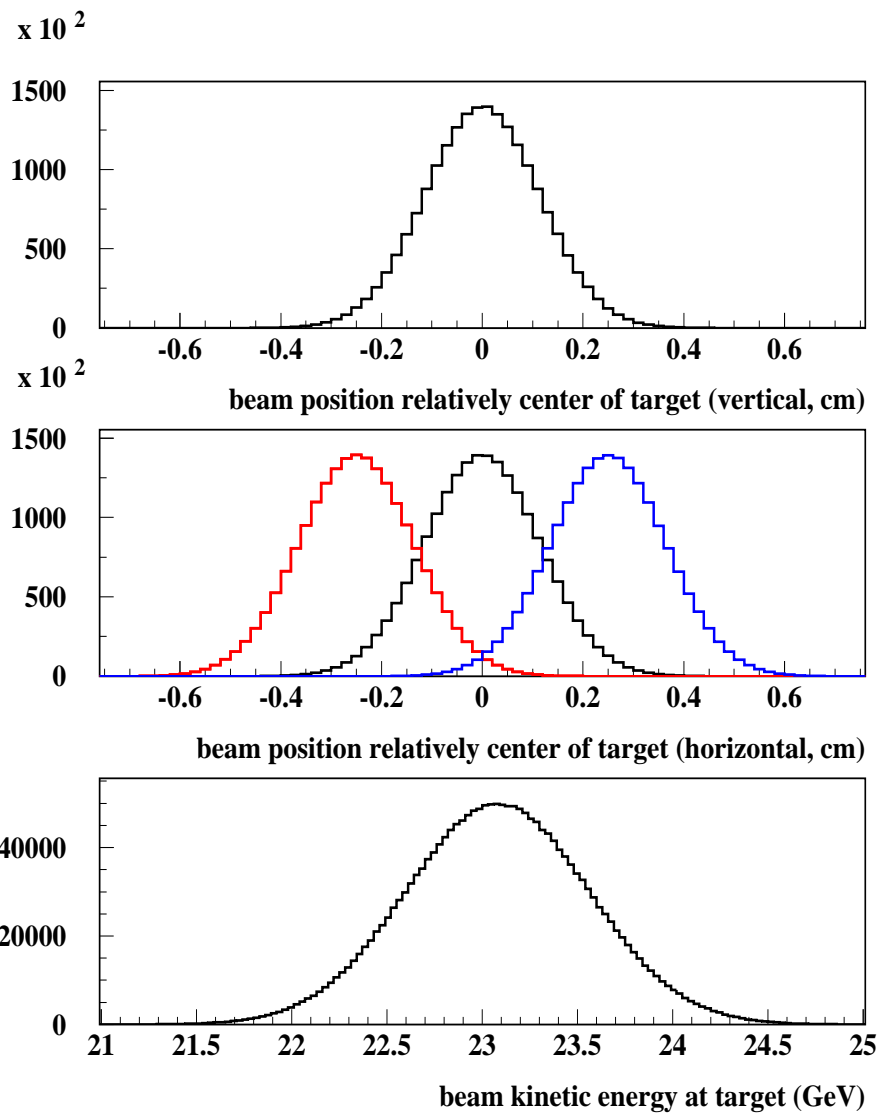

Detector positions in experiment

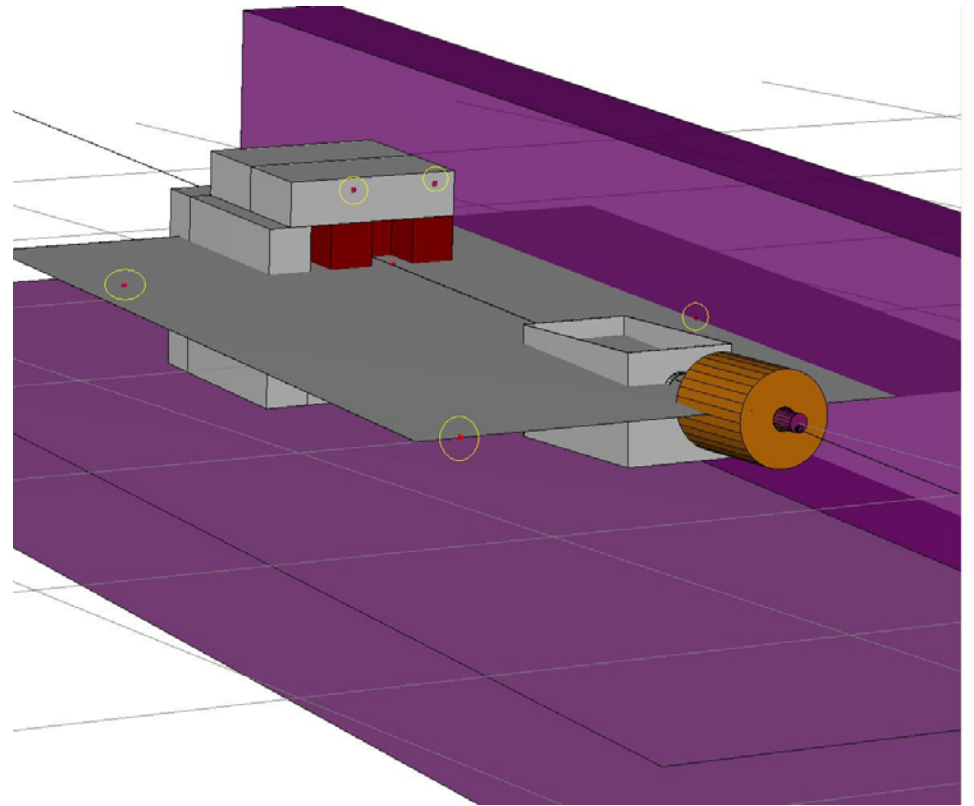
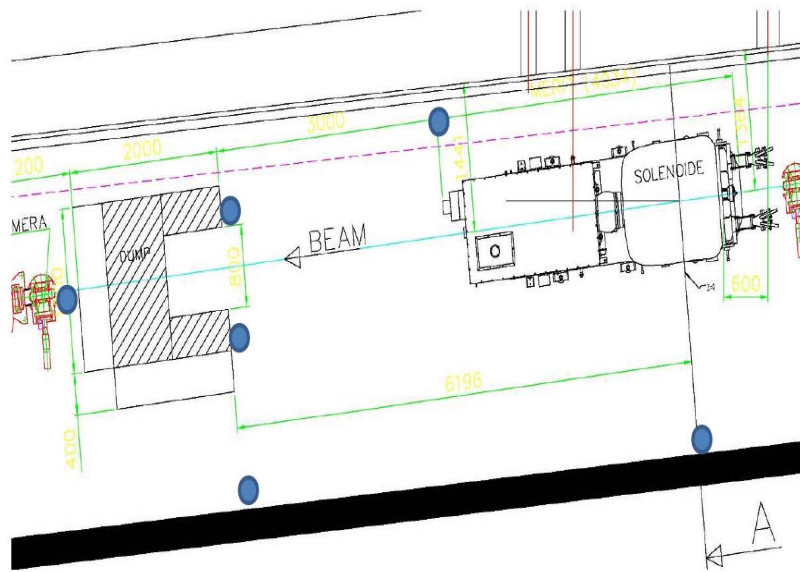

Charged particle flux [cm⁻²] - Hg out

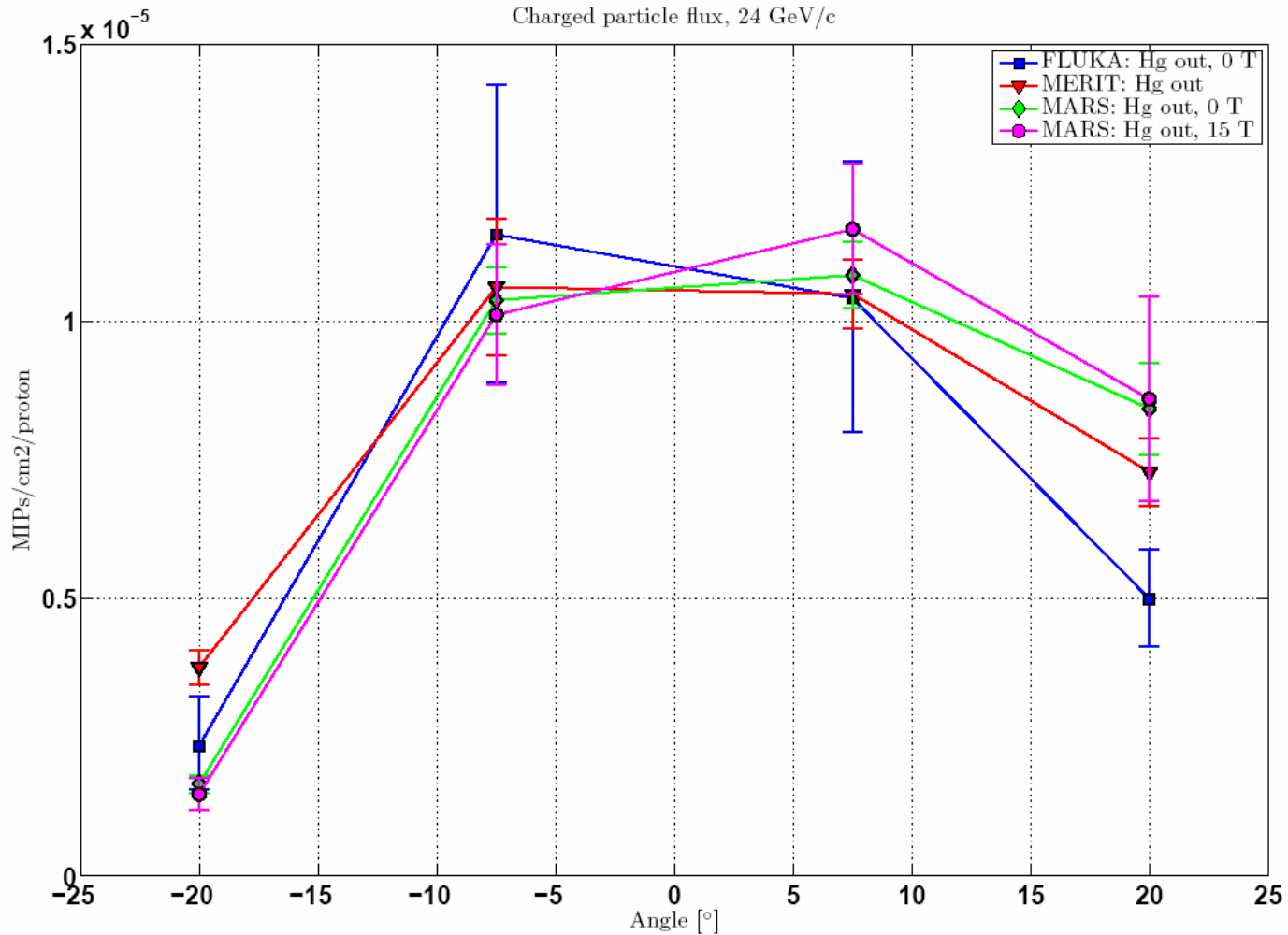

Charged particle flux [cm⁻²] - Hg in

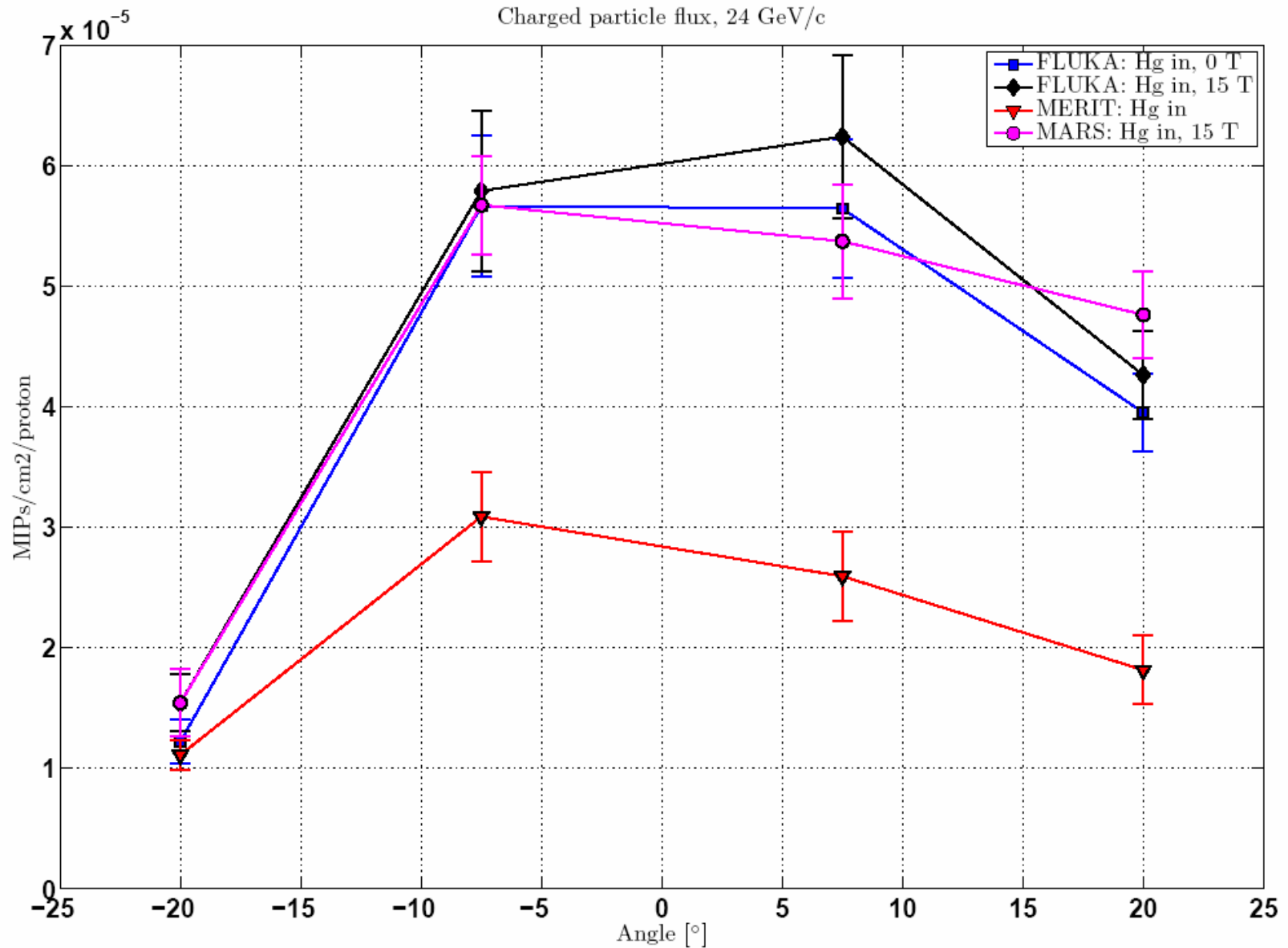

Energy deposition in Hg jet

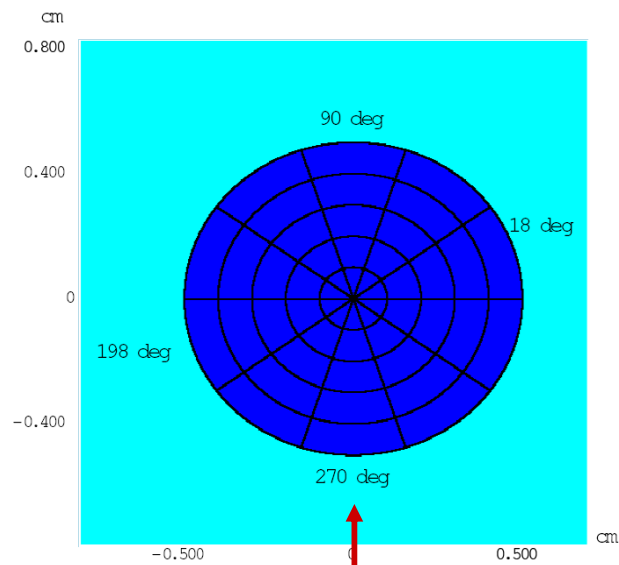
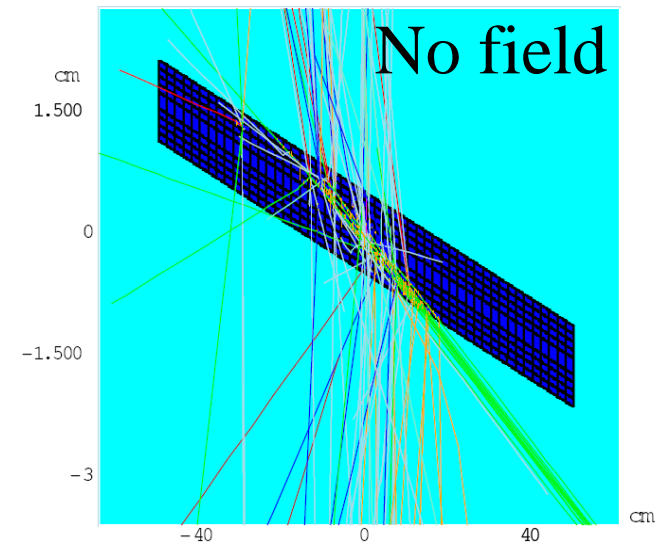
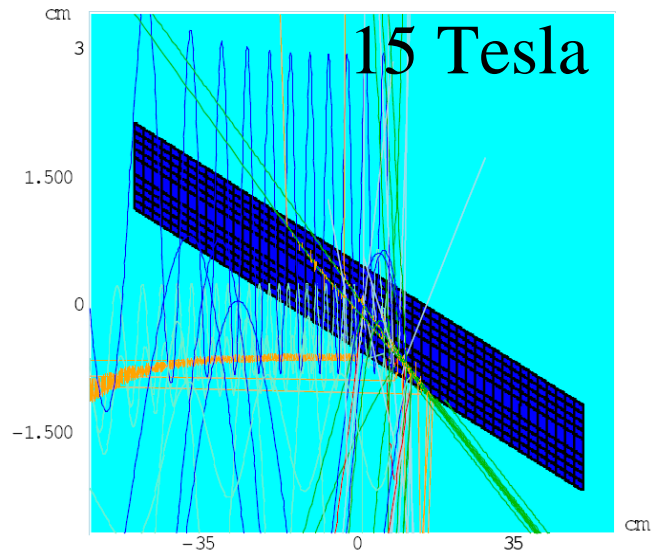

beam

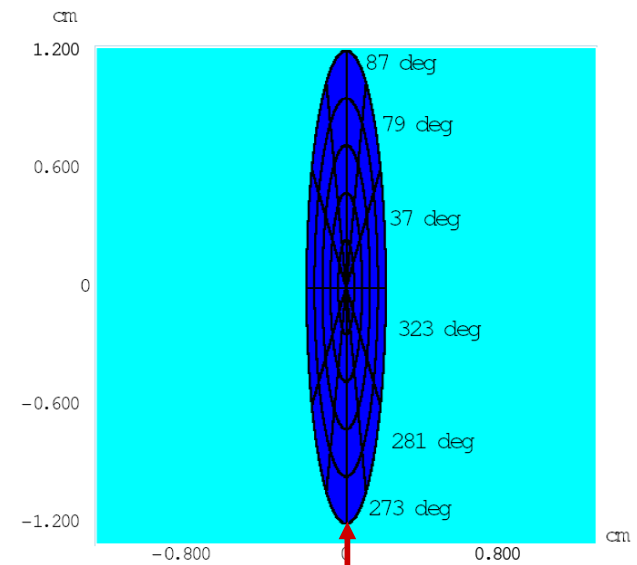

beam

Energy deposition in Hg jet at 24 GeV/c 15 Tesla, circle

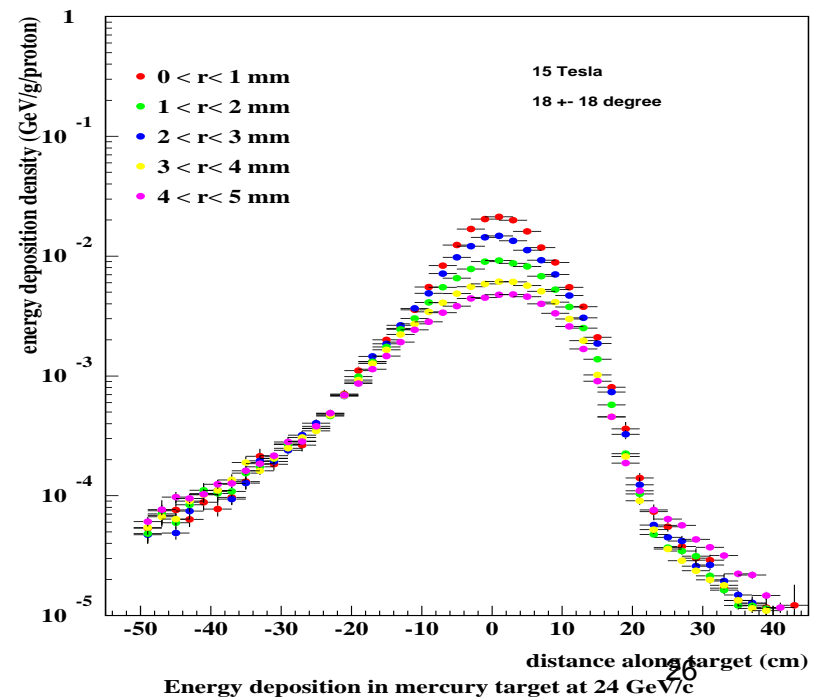
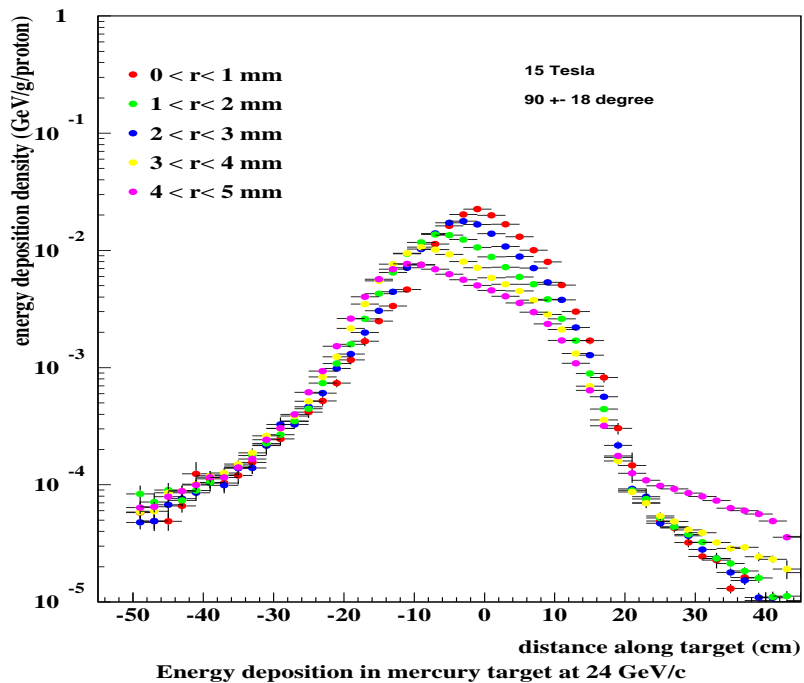
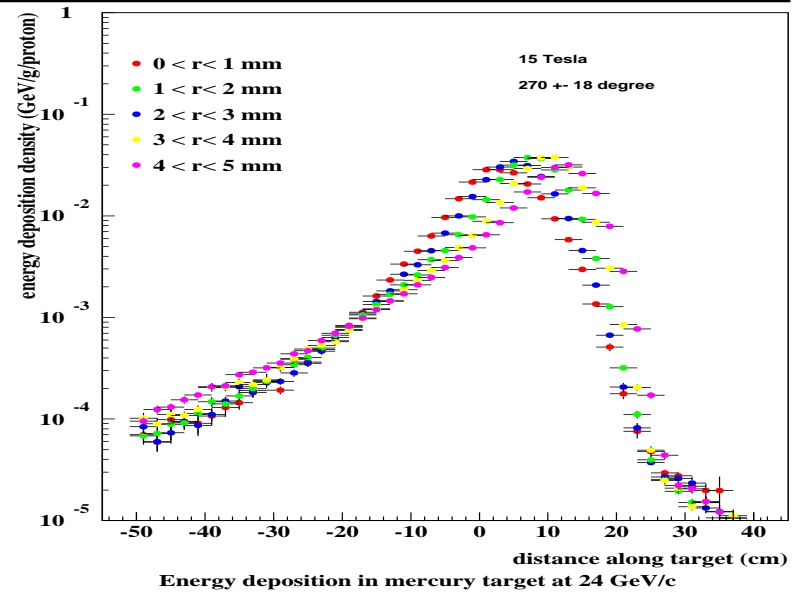
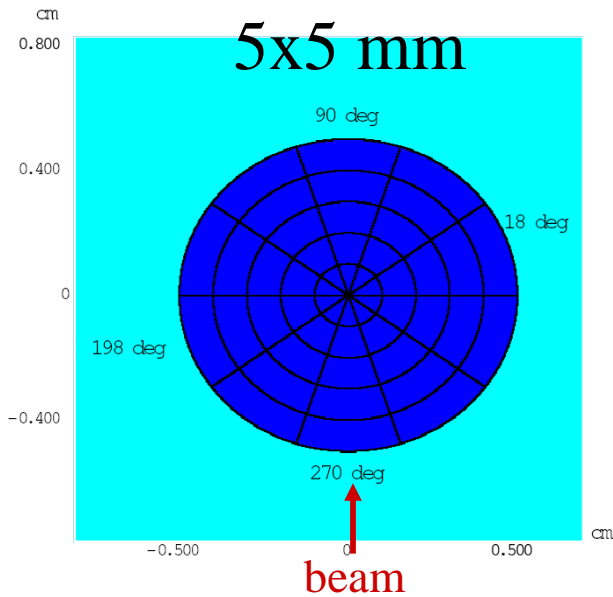

Energy deposition in Hg jet at 24 GeV/c, 0 and 15 Tesla, circle

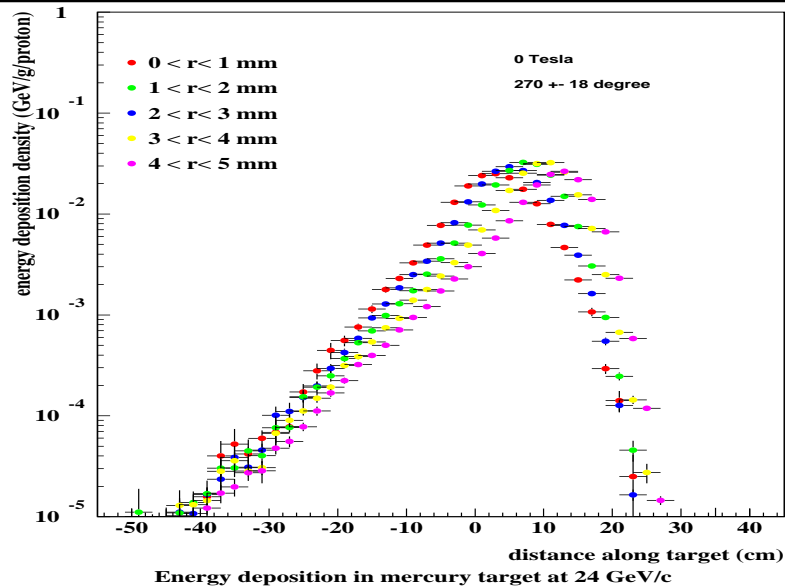

0 Tesla

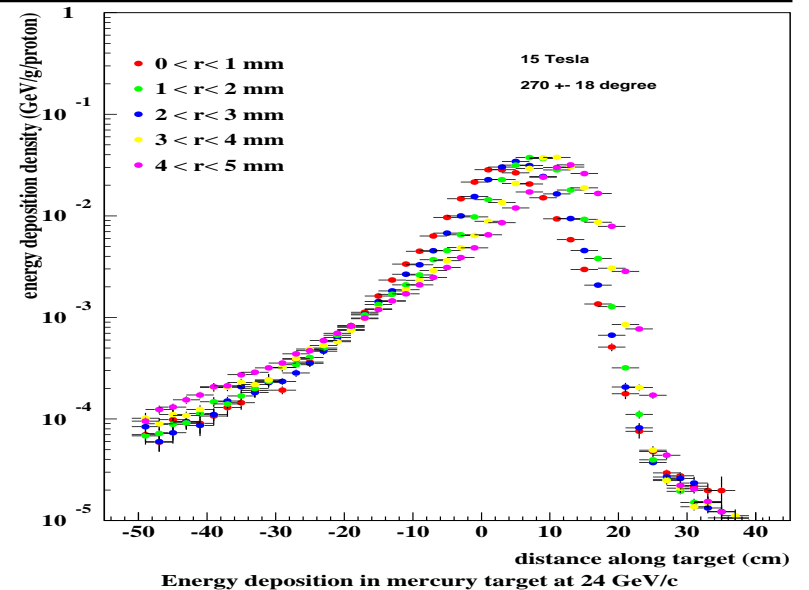

15 Tesla

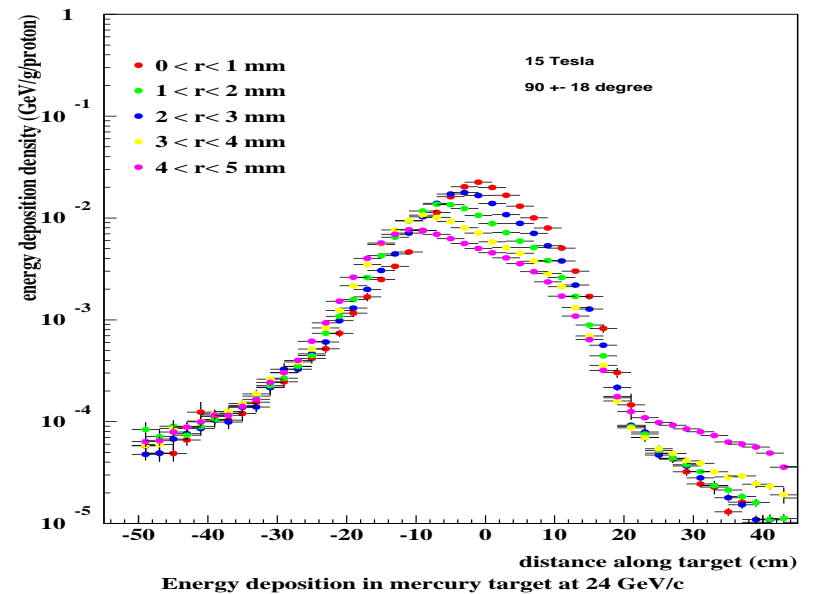
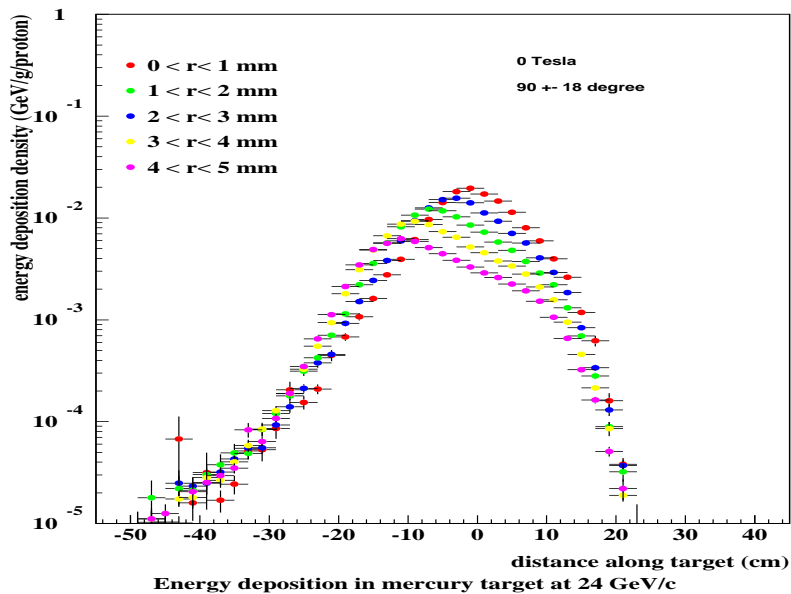

Energy deposition in Hg jet at 24 GeV/c 15 Tesla, ellipse

12x2 mm

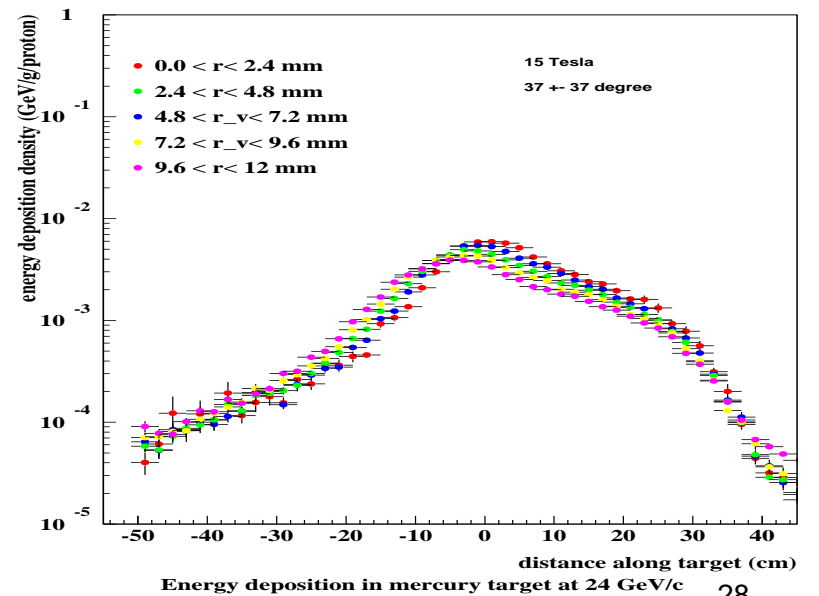
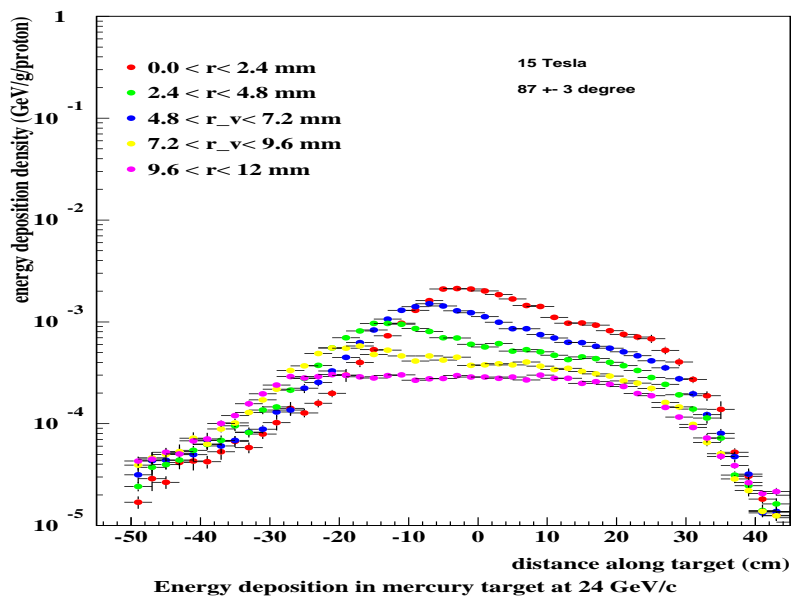
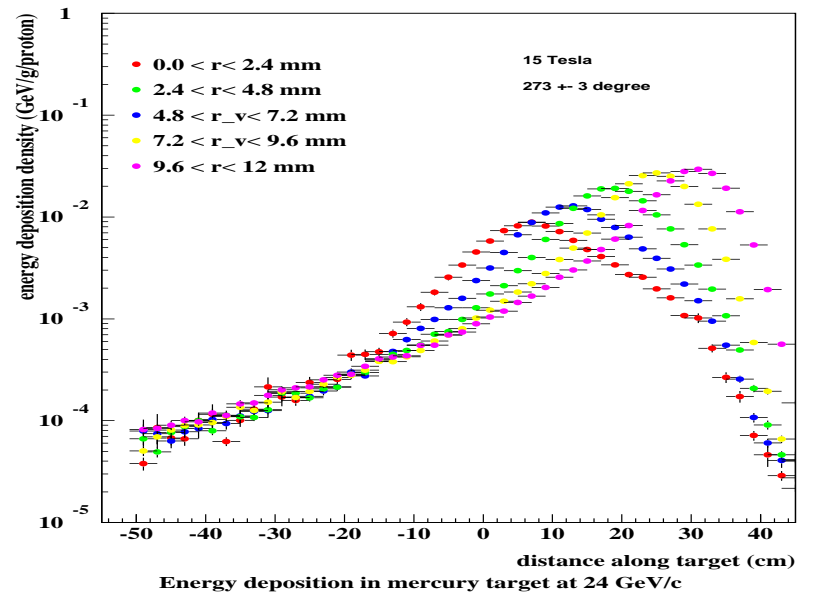
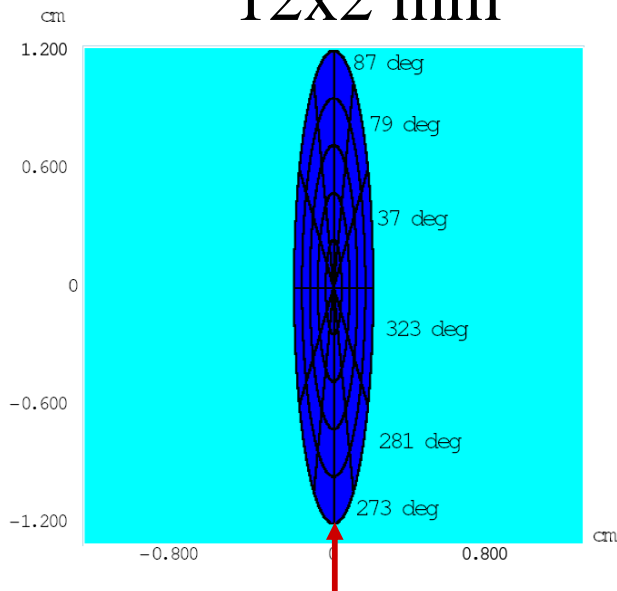

Energy deposition in Hg jet at 24 GeV/c 0 and 15 Tesla, ellipse

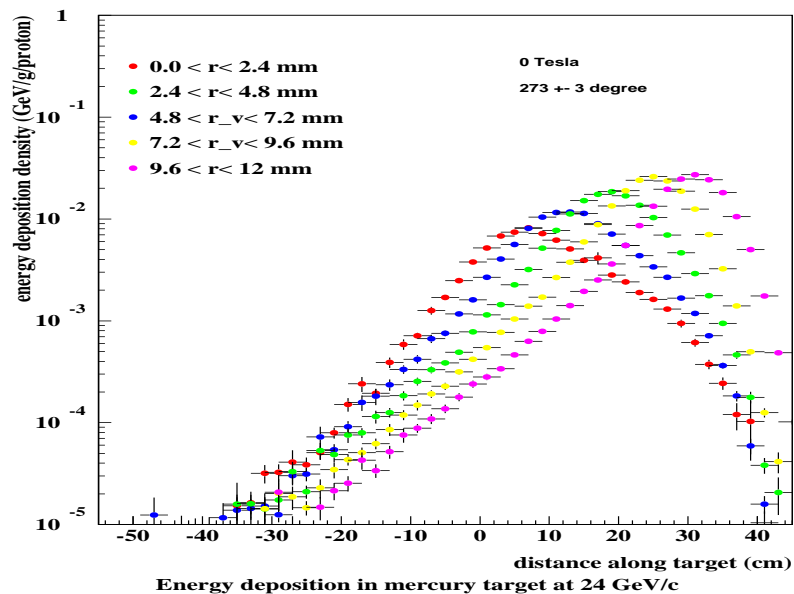

0 Tesla

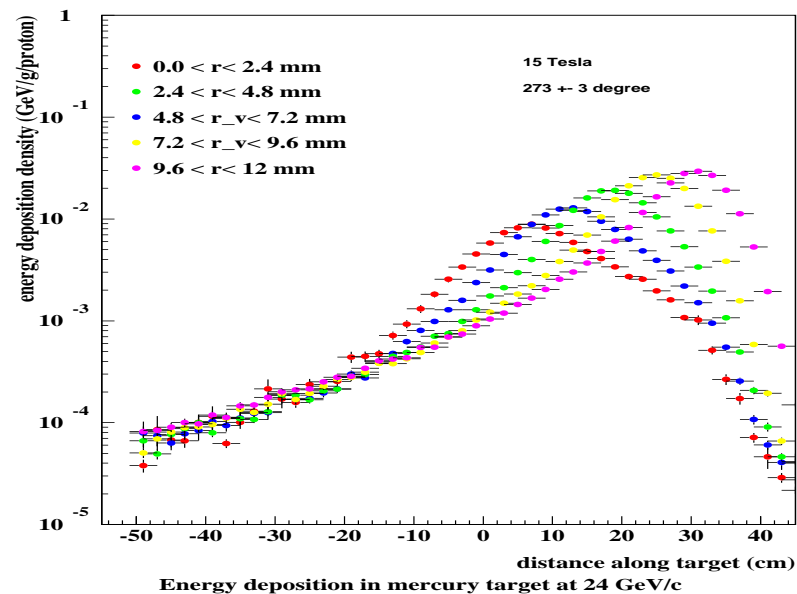

15 Tesla

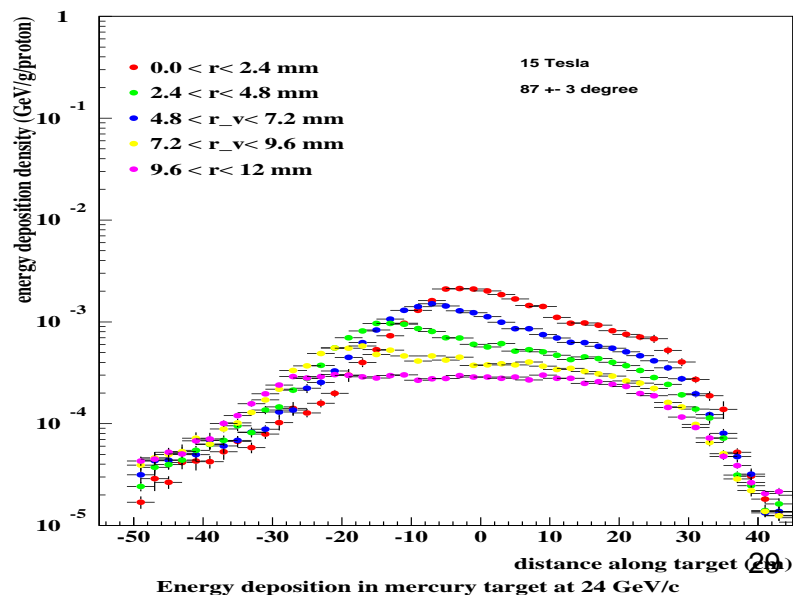
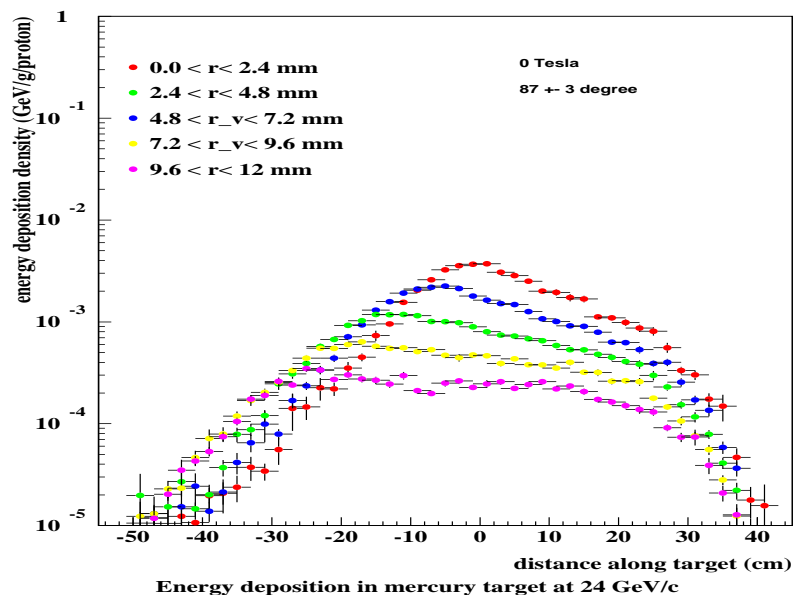

Energy deposition in Hg jet

❖ Energy deposition density in Hg target was calculated for MERIT momenta 14 and 24 GeV/c (3×10^{13} proton/pulse) and new muon collider baseline 56 GeV/c (4×10^{13} proton/pulse) for circular and elliptical shapes. Beam spot size on target had radial rms of 1.6 mm

❖ Peak energy deposition densities (15T, 5x5 mm) are 125, 182, 655 J/g/pulse

❖ Total energy depositions in jet (15T, 5x5 mm) are 6.7, 12 and 46 kJ/pulse

❖ Total energy deposition is about 30% higher at 15 Tesla than at 0 Tesla for circular and elliptical jets

❖ Peak energy deposition in elliptical target is practically independent of magnetic field value

❖ Peak energy deposition in cylindrical jet is about 15% higher at 15 Tesla than at 0 Tesla

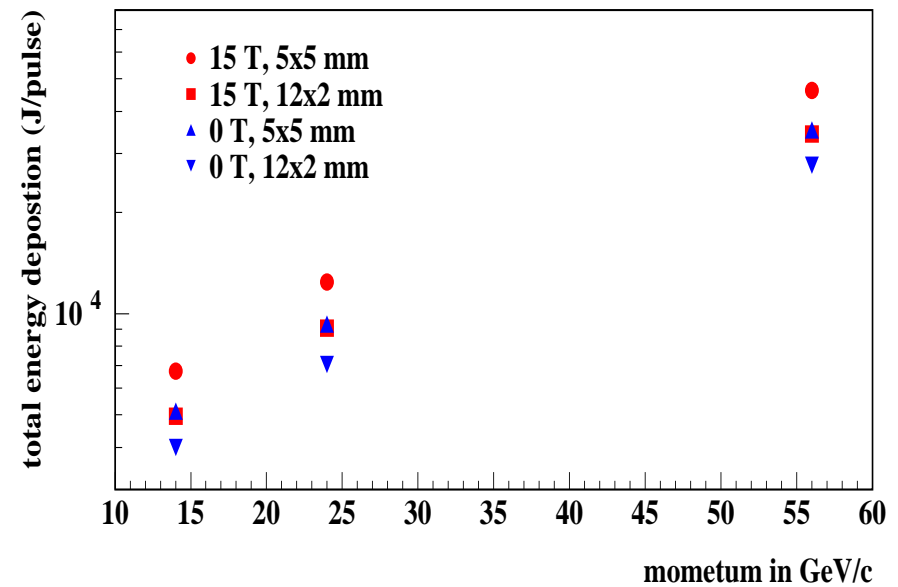
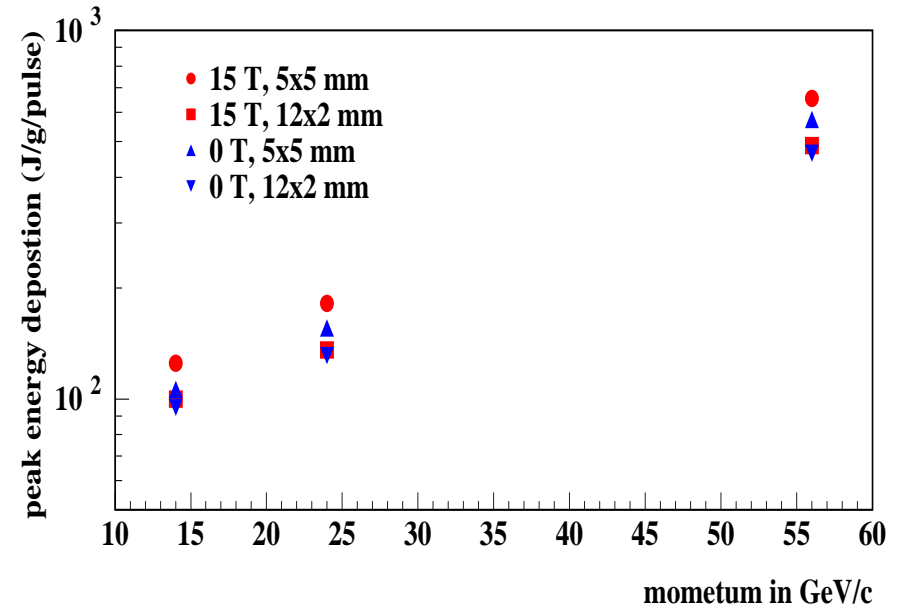

Backup slides

Neutron flux (1/cm² per 3 10¹³ protons on target)

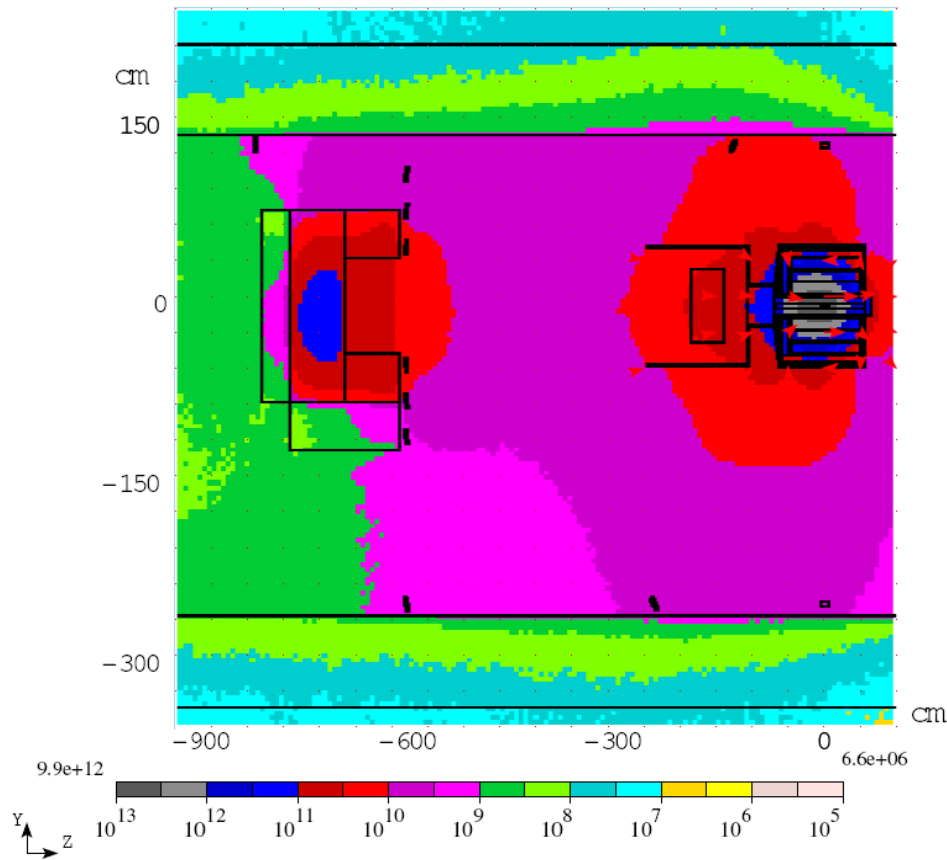

15 Tesla

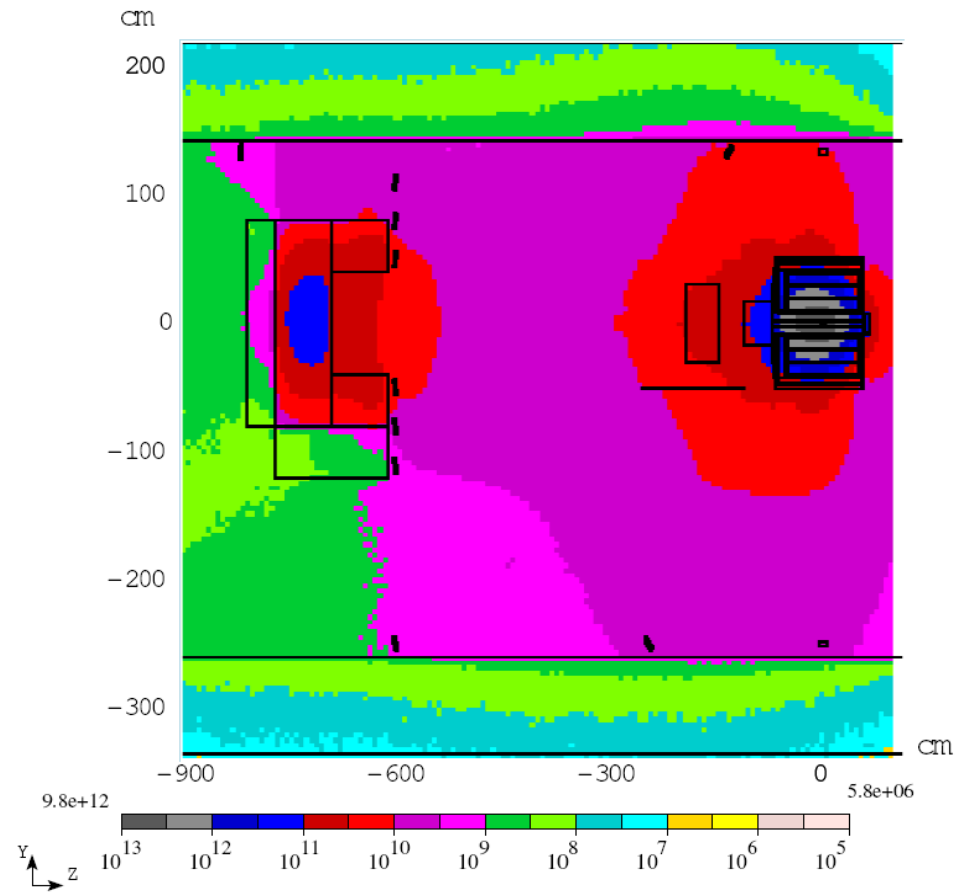

No magnetic field

Muon flux (1/cm² per 3 10¹³ protons on target)

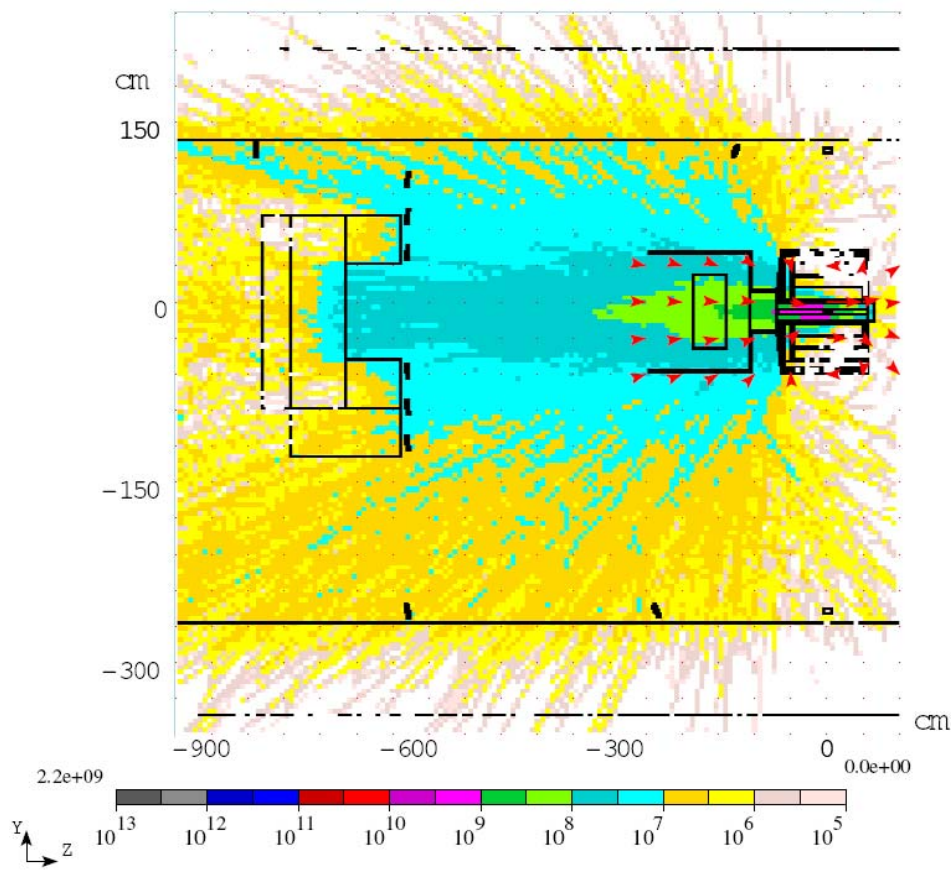

15 Tesla

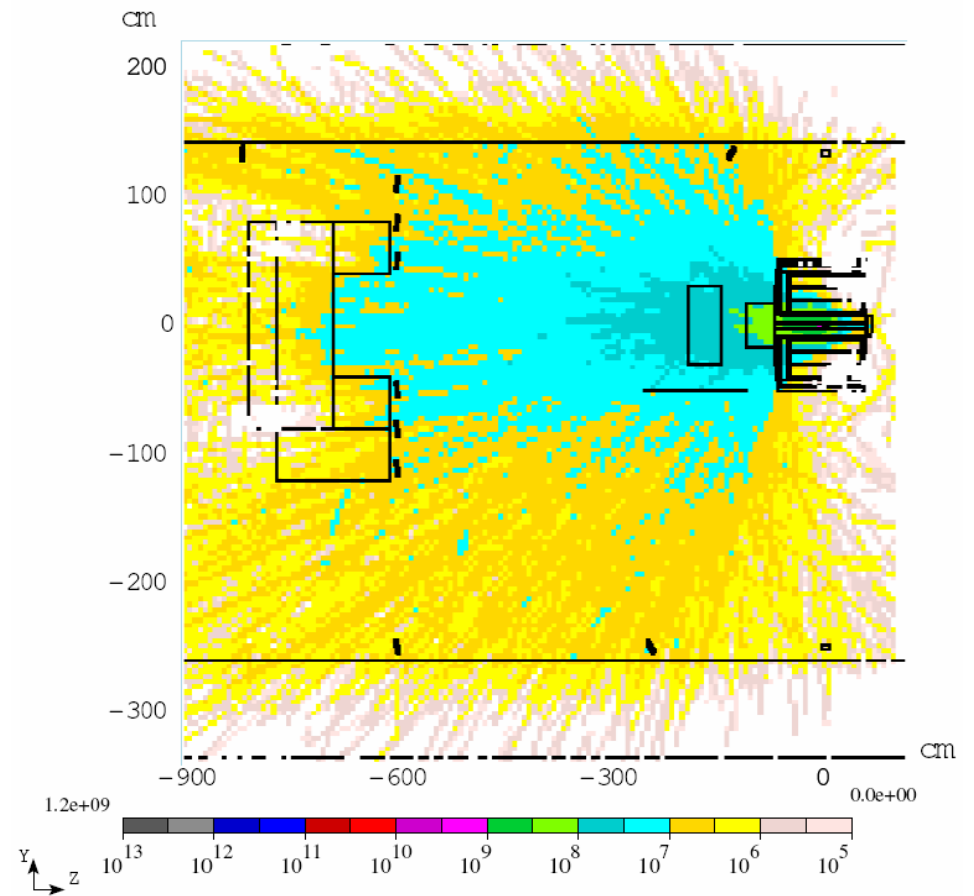

No magnetic field

Proton flux (1/cm² per 3 10¹³ protons on target)

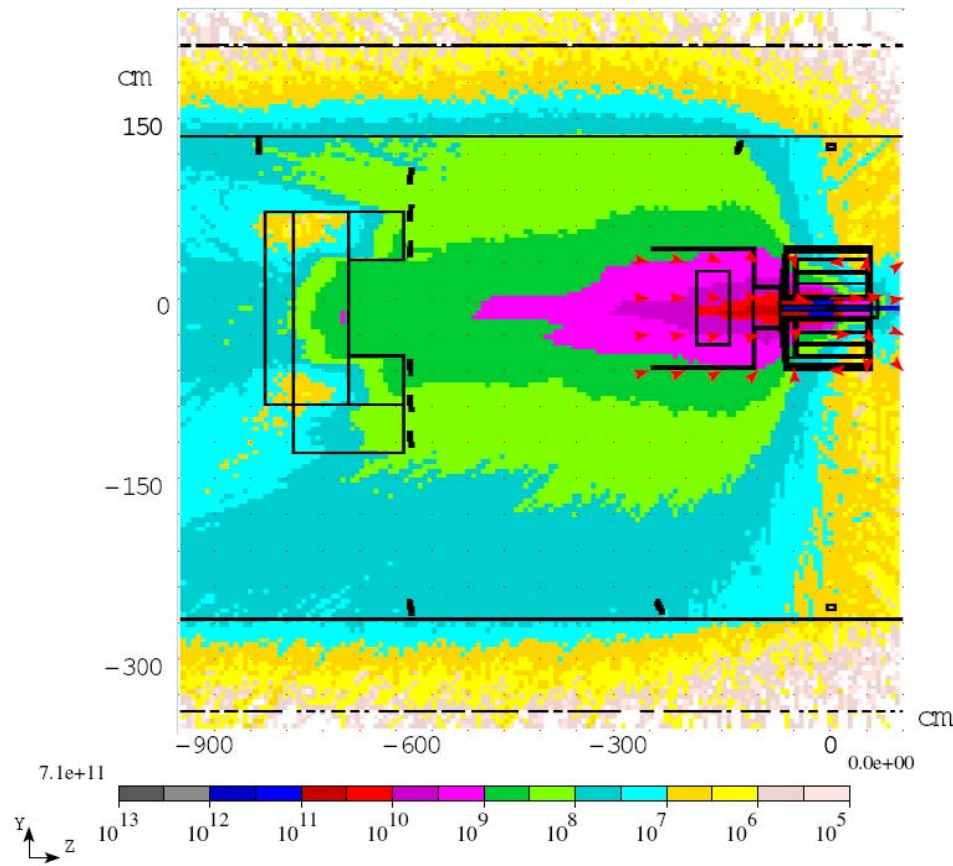

15 Tesla

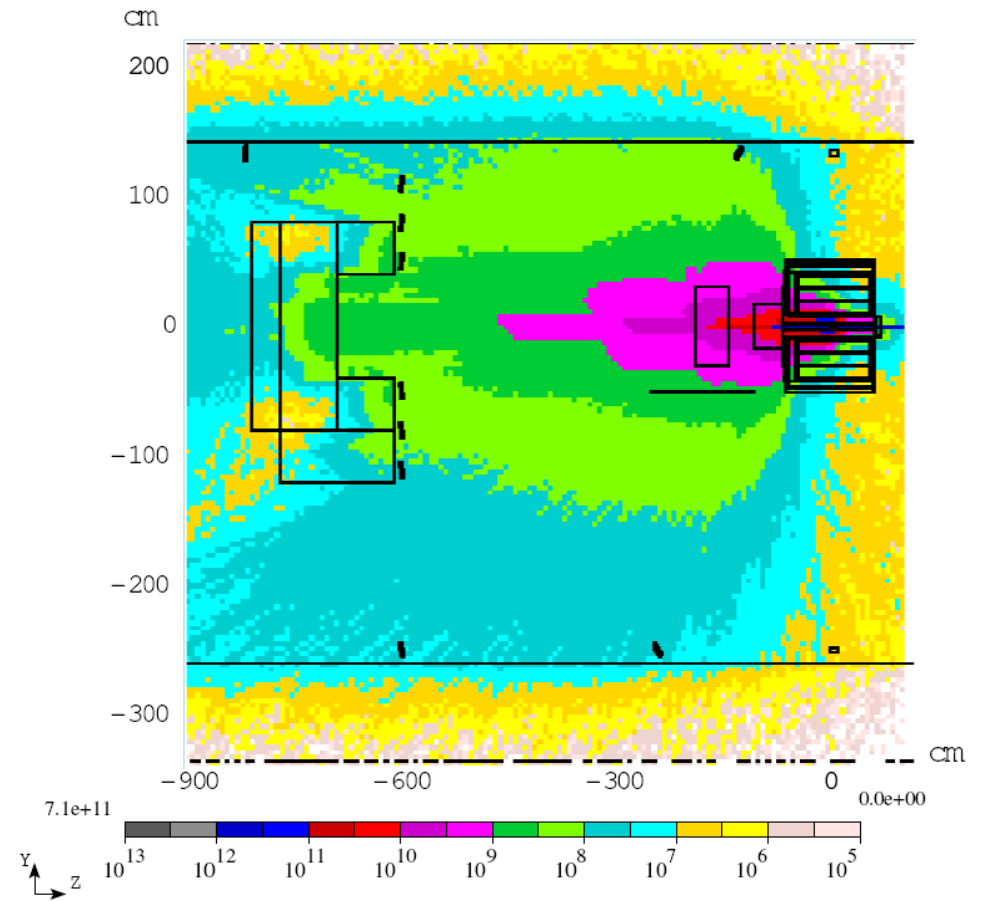

No magnetic field

Charged pion/kaon flux (1/cm² per 3 10¹³ protons on target)

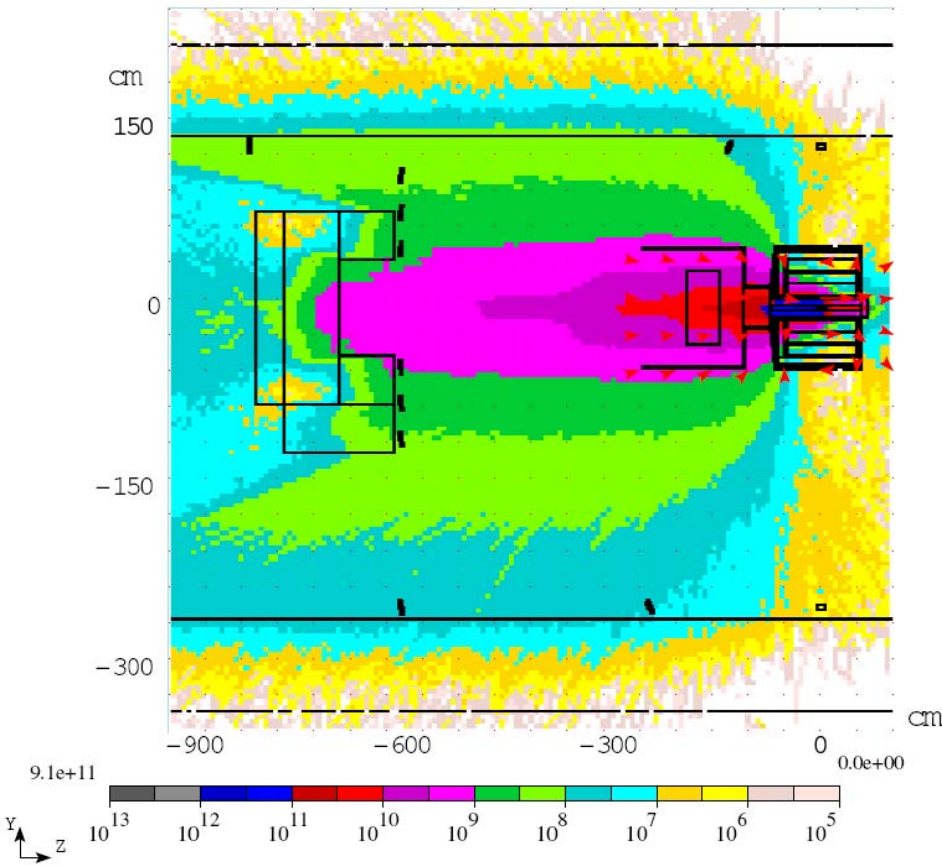

15 Tesla

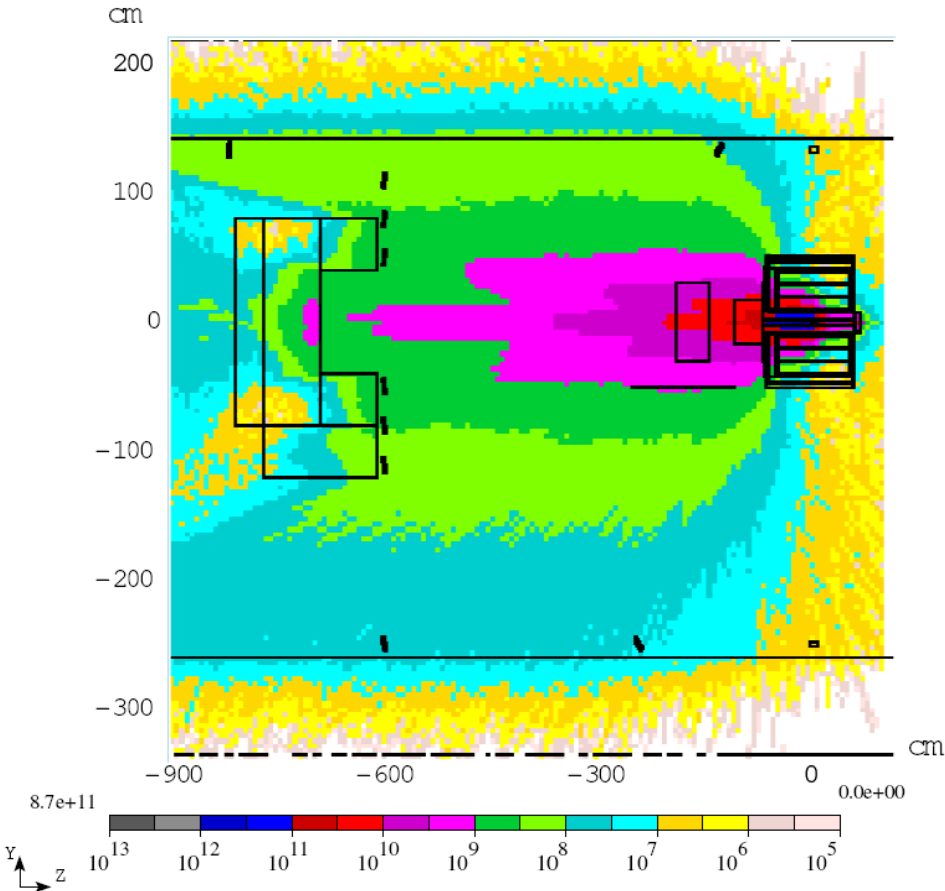

No magnetic field

Energy deposition in detectors. No target.

Detector 1: -90 degree
Detector 2: -45 degree
Detector 3: -22 degree
Detector 4: -10 degree
Detector 5: -7.5 degree
Detector 6: -4.7 degree
Detector 7: 4.7 degree
Detector 8: 7.5 degree
Detector 9: 10 degree
Detector 10: 45 degree
Detector 11: 90 degree
Detector 12: 9 degree
Detector 13: 0 degree

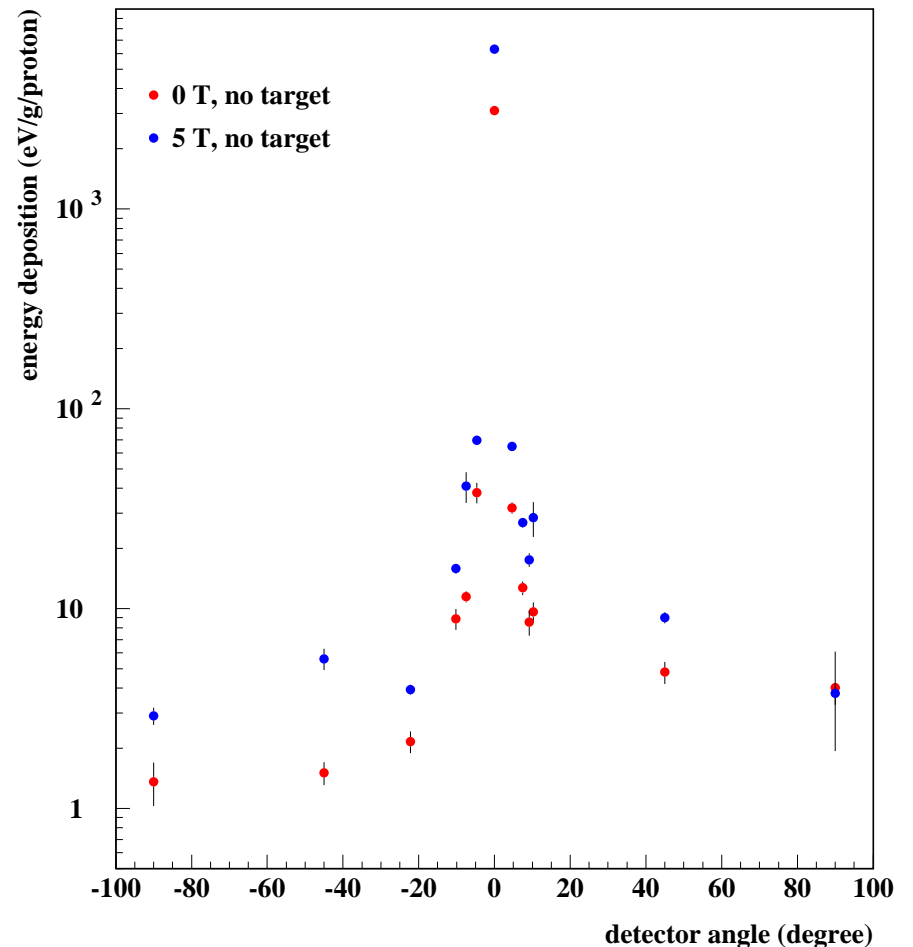

24 GeV/c - Hg out

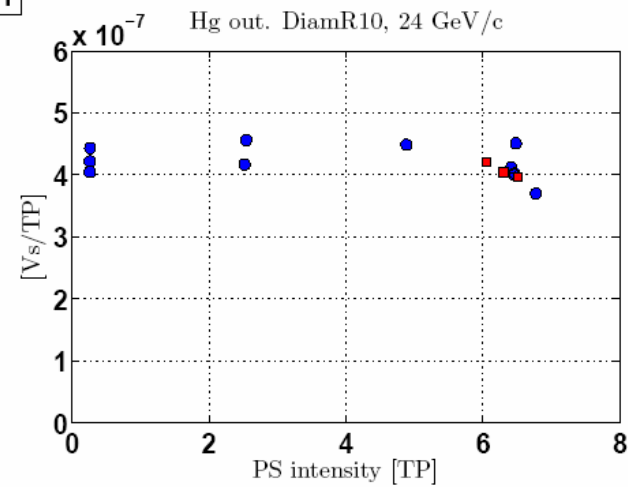
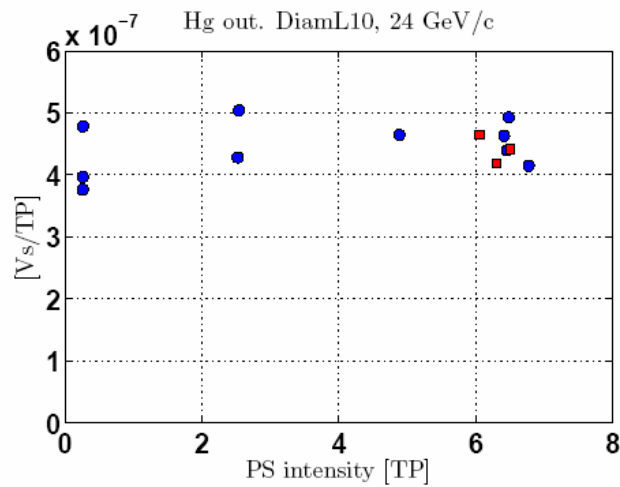
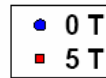
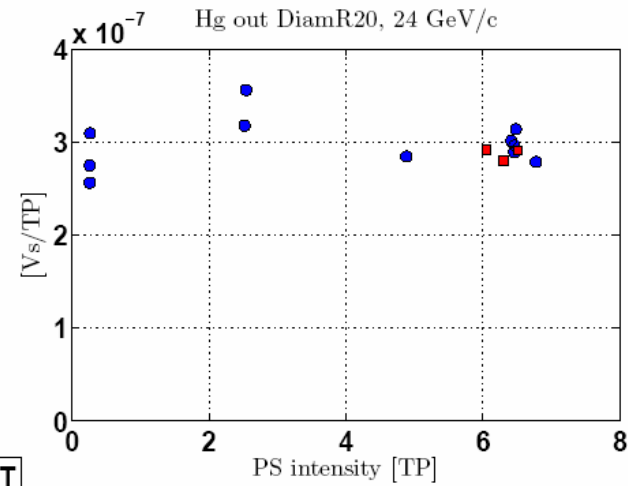
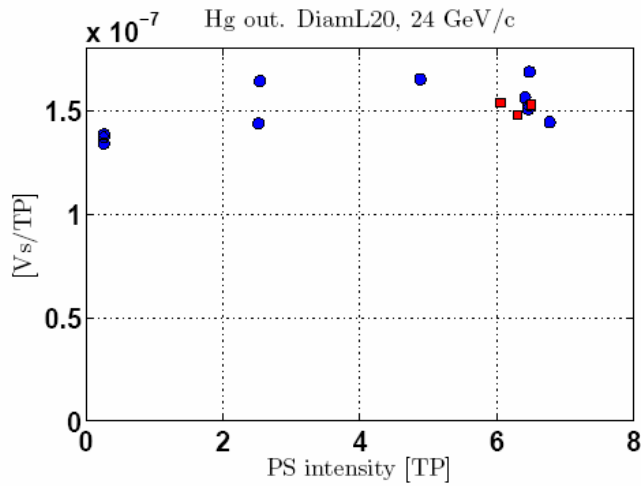

24 GeV/c - Hg in

