

DESIGN OF THE MERCURY HANDLING SYSTEM FOR A MUON COLLIDER/NEUTRINO FACTORY TARGET*

V.B. Graves[†], *Oak Ridge National Laboratory, Oak Ridge, TN 37830, USA*
 H.K. Sayed[‡], J.S. Berg, H.G. Kirk, *Brookhaven National Laboratory, Upton, NY 11973, USA*
 X. Ding, *UCLA, Los Angeles, CA 90095, USA*
 N. Souchlas, R.J. Weggel, *Particle Beam Lasers, Northridge, CA 91324, USA*
 K.T. McDonald, *Princeton University, Princeton, NJ 08544, USA*

Abstract

The baseline target concept for a Muon Collider or Neutrino Factory is a free mercury jet within a 20-T magnetic field being impacted by an 8-GeV proton beam. A pool of mercury serves as a receiving reservoir for the mercury and a dump for the unexpended proton beam. Modifications to this baseline are discussed in which the field at the target is reduced from 20 to 15 T, and in which the magnetic field drops from its peak value down to 1.5 T over 7 rather than 15 m.

INTRODUCTION

The baseline target concept for a Muon Collider or a Neutrino Factory is a free jet of mercury impacted by a 4-MW, 8-GeV proton beam at 50 Hz within a 20-T magnetic field [1]. The magnetic field is produced by a coaxial array of cryogenically cooled superconducting (SC) coils and water-cooled resistive magnets. During operation, the Target Module resides within a shielding module that protects the SC coils from the impinging radiation. The arrangement of these modules inside a cryostat is shown in Fig. 1.

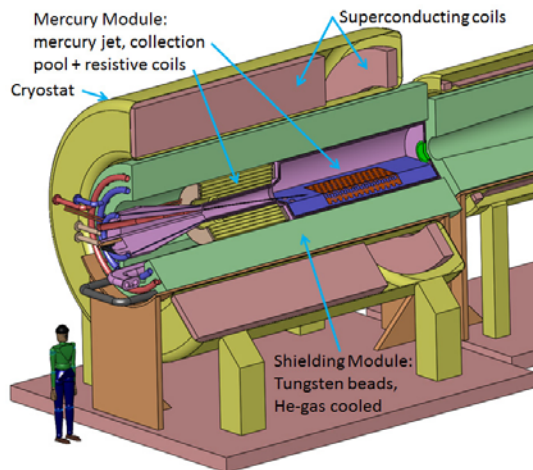

Figure 1: Neutrino Factory/Muon Collider Target System.

* Work supported by the US DOE Contract No. DE-AC02-98CH110886 and DE-AC05-00OR22725.

[†] gravesvb@ornl.gov

[‡] hsayed@bnl.gov

A preliminary vision of the relation of the target modules to their external mercury-handling services, and of the assembly procedure of the Mercury Target Module into the surrounding cryostat, was presented in [2], as is illustrated in Figs. 2 and 3.

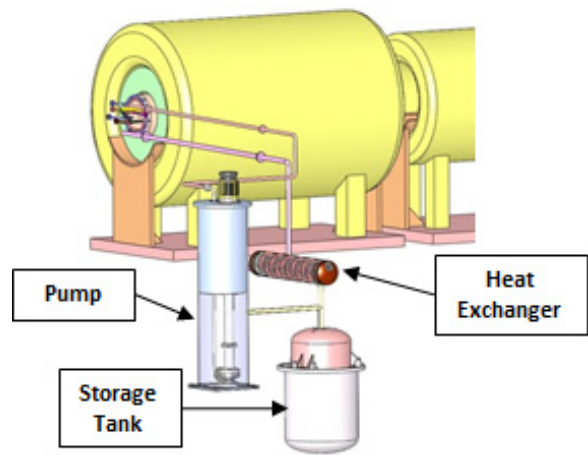

Figure 2: The external components of the mercury-flow loop.

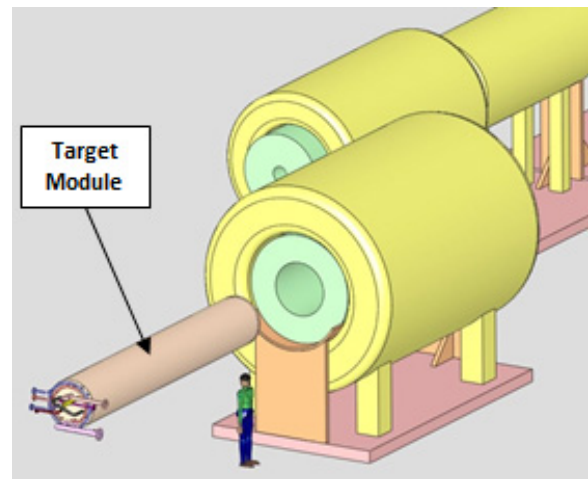

Figure 3: Mercury Target Module extracted from the Shielding Module and surrounding cryostat.

The baseline target module, sketched in Fig. 1, has the

complexity that the mercury double-containment vessel must pass through the small bore of the 5-T resistive coil that augments the 15-T field from the outer superconducting coils to bring the field on target to 20 T. Recent studies [4] have showed that the target system can still deliver a good yield of pions/muons with only a 15-T magnetic field around the target, provided the transition magnets between the high field on the target and the low (1.5 T) field in the subsequent beam transport is reoptimized. This paper presents configurations of the Mercury Target Module and of the surrounding magnet cryostat that are compatible with this revised scenario.

NEW TARGET SYSTEM CONFIGURATIONS

The baseline configuration of the Target-System magnets has 20 T on the target but only 1.5 T in the solenoids of the constant-field Decay Channel (with superconducting coils) that begins 15 m downstream of the target [3], as shown in the top of Fig. 4.

Alternative configurations in which the constant-field Decay Channel begins only 7 m downstream of the target, to improve the longitudinal phase-space distribution of the muon beam [4], are shown in the middle and bottom of Fig. 4, with peak fields of 20 and 15 T, respectively.

These alternative configurations require modifications to the Mercury Module, as sketched in Fig. 5. The top figure is for baseline configuration, with 20-T field at the target. The middle figure is for a configuration with 20 T at the target, and the constant-field Decay-Channel beginning only

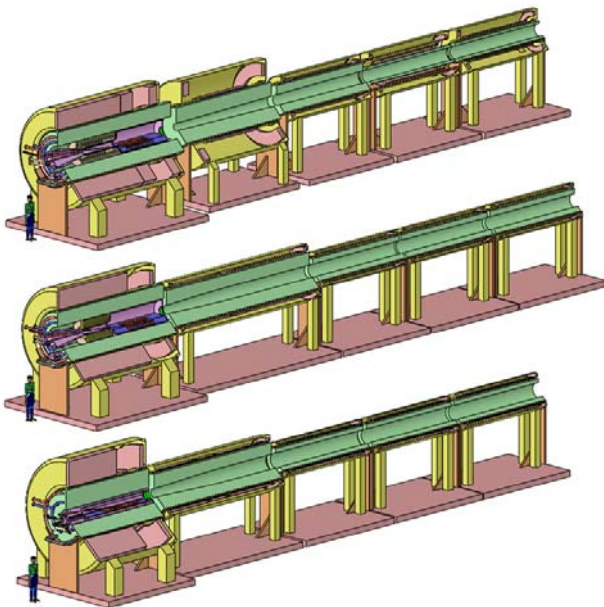

Figure 4: Target-System magnet configurations with 20 T (top, middle) or 15 T (bottom) at the target, which ramp the magnetic field down to 1.5 T over 15 m (top) or 7 m (middle, bottom).

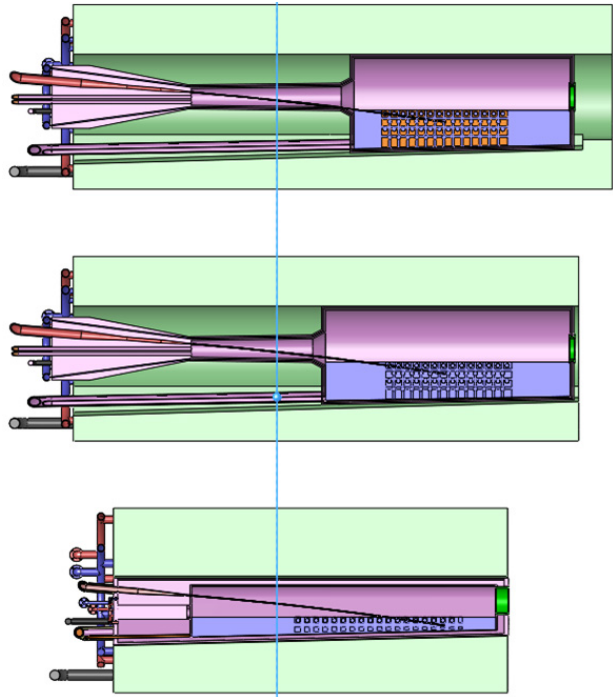

Figure 5: Mercury Modules (inside the He-gas-cooled, tungsten-bead Shielding Modules) of Target-System magnet configurations with 20 T (top, middle) or 15 T (bottom) at the target, which ramp the magnetic field down to 1.5 T over 15 m (top) or 7 m (middle, bottom). The vertical line is at $z = 0$ = downstream end of the beam-target interaction region.

7 m downstream of the target, which permits a shorter Mercury Module. However, both of the 20-T configurations require resistive coils closely surrounding the target, which leads to the awkward “neck” in the Mercury Module seen in the figure.

These 20-T configurations significantly increase the complexities associated with the design and fabrication of the Mercury Modules. It is expected that the mercury loop (pump, heat exchanger, piping, nozzle and mercury pool containment vessel) be a closed system with no flanges (and their associated seals) within the Mercury Module itself. Thus, final fabrication of the Mercury Module would need to be performed with the resistive coils in place. This arrangement combines the resistive coils and the mercury vessel into a single Target Module that would be remotely handled as a single unit. Structural support of the coils in this Target Module would further complicate its design and ultimately increase the modules size, thus reducing the amount of tungsten shielding available to protect the superconducting coils. No provision for shielding the resistive coils was included in these concepts, which again further increases complexity and likely the overall module size. Finally, having a dual-function Target Module means that a failure, or reaching an end-of-life condition due to radiation damage, of either part of the module would necessitate

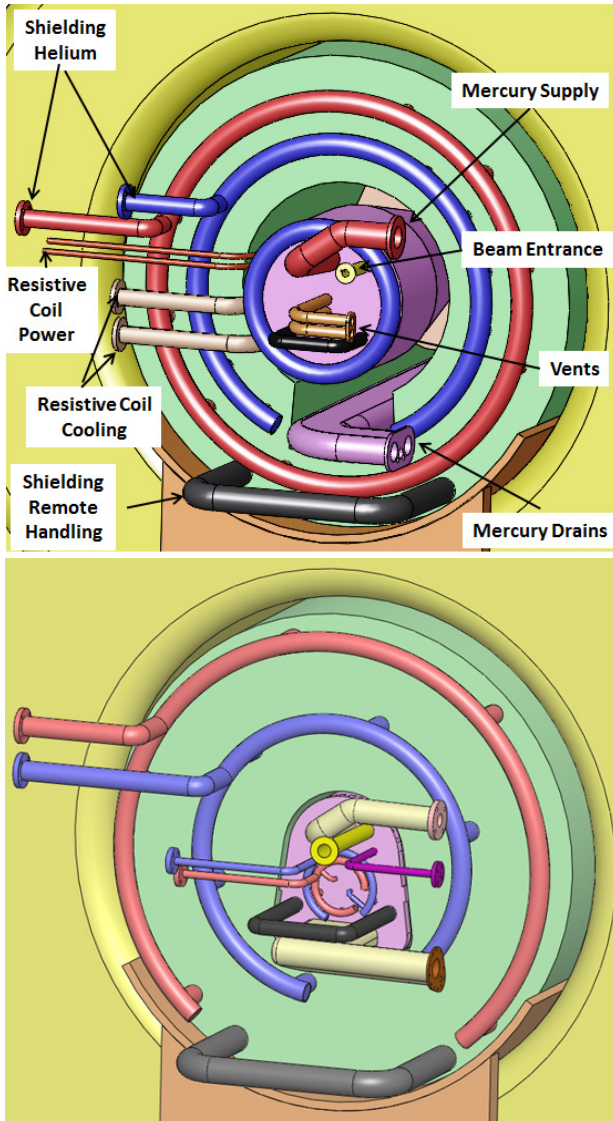

Figure 6: Services on the upstream faces of the Mercury Modules for configurations with 20 T (top) and 15 T (bottom) at the target.

disposal of the entire module, since remote assembly and disassembly of such a complex module is highly unlikely.

The alternative configuration with 15 T at the target permits a much simpler design of the Mercury Module, as sketched in the bottom of Fig. 5, and also in Fig. 7. This relative simplicity is also exhibited in the layout of the services on the upstream face of the Mercury and Shielding Modules, as sketched in Fig. 6. Inlets and outlets are required on the face of the Shielding Module for the high-pressure He-gas that cools the tungsten beads that comprise the shielding; a handle at the bottom of the Shielding Module is for use during (dis)assembly. The Mercury Module has inlets and outlets for the mercury, as well as vent lines needed during full draining; a proton beam port; and inlet and outlets for He-gas cooling of the walls of the mercury double-containment vessels. In addition, the Mercury

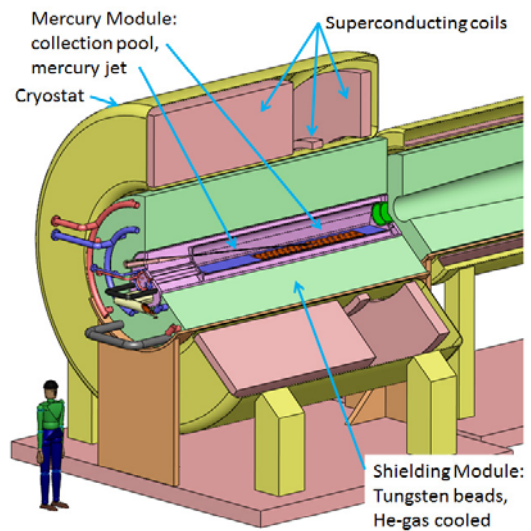

Figure 7: Target System with 15T on target (no resistive coils).

Module for the 20-T configuration has power leads for the 5-T resistive coils, and inlets and outlets for water cooling of those coils.

REFERENCES

- [1] M.M. Alsharo'a *et al.*, *Status of Neutrino Factory and Muon Collider Research and Development and Future Plans*, Phys. Rev. ST Accel. Beams **6**, 081001 (2003).
- [2] V.B. Graves *et al.*, *Mercury Handling for the Target System for a Muon Collider*, IPAC12, WEPPD038.
- [3] R.J. Weggel *et al.*, *Shielding of Superconducting Coils for a 4-MW Muon-Collider Target System*, IPAC12, WEPPD037.
- [4] H.K. Sayed *et al.*, *Optimizing Muon Capture and Transport for a Neutrino Factory/Muon Collider Front End*, IPAC13, THPFI075.