

# The Potential of Fluidised Powder Target Technology in High Power Accelerator Facilities

Chris Densham, Ottone Caretta, Peter Loveridge  
(Rutherford Appleton Laboratory),  
Richard Woods (Gericke Ltd),  
Tom Davies (Exeter University)

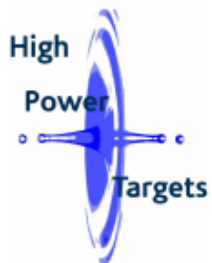

# Motivations: what are the limits for solid targets? E.g. T2K Graphite target for 750 kW operation?

Pion production target inside magnetic horn for 'conventional' neutrino beam ( $\nu_\mu \rightarrow \nu_e$  oscillations)

First Beam: 23<sup>rd</sup> April 2009

Phase I :30 GeV, 750 kW beam

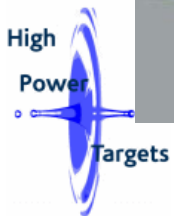
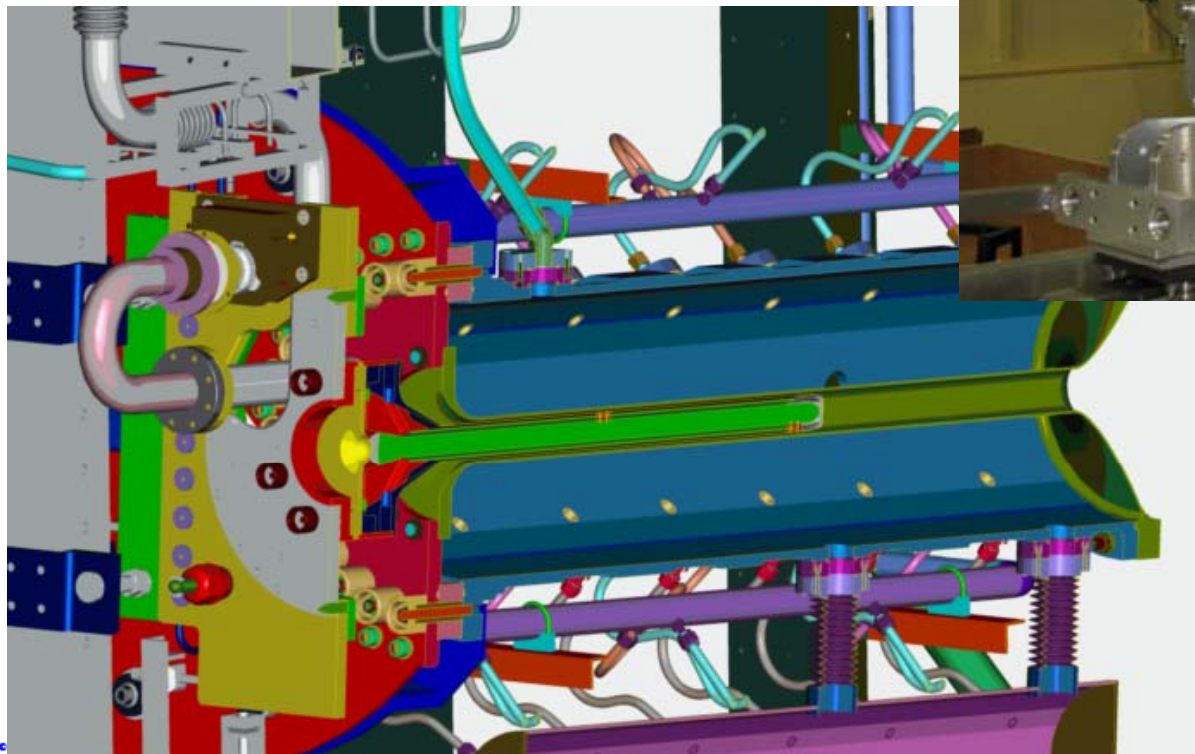

Chris Densham

5 year roadmap: 1.66 MW

Ultimate: 3-4 MW

**Target options?**



# Powers and power densities in a few target systems using proton accelerator drivers

	Material	Proton beam energy	Power in target kW	Peak power density J/cc/pulse	Pulse length
T2K (JPARC) Phase 1	Graphite	30-50 GeV	30	344	$5 \times 10^{-6}$ s
Neutrino Factory	Hg jet or tungsten	5-15 GeV	1000	300	Few $\times 10^{-9}$ s
SNS (ORNL)/ J-SNS (JPARC)	Contained Liquid Hg	1 GeV  3 GeV	1400  1000	10  17	$10^{-6}$ s
Pbar (FNAL)	Ni, ++	120 GeV	200	25000	$5 \times 10^{-9}$ s

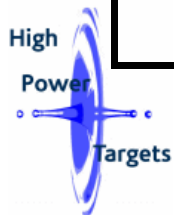

Chris Densham



Science & Technology Facilities Council  
Rutherford Appleton Laboratory

# Broken graphite targets / samples from existing accelerator facilities

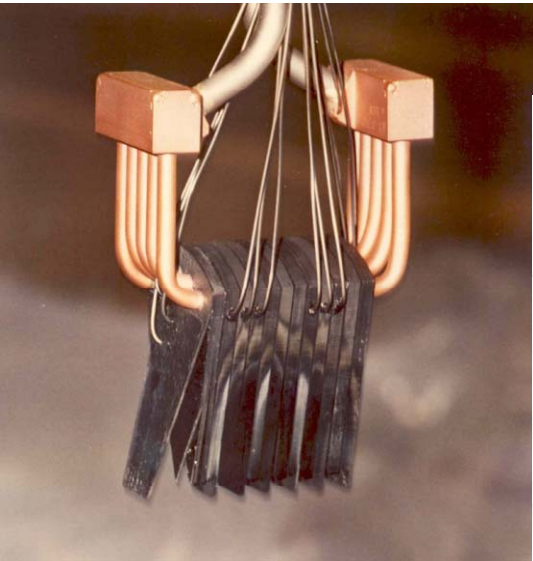

LAMPF



PSI

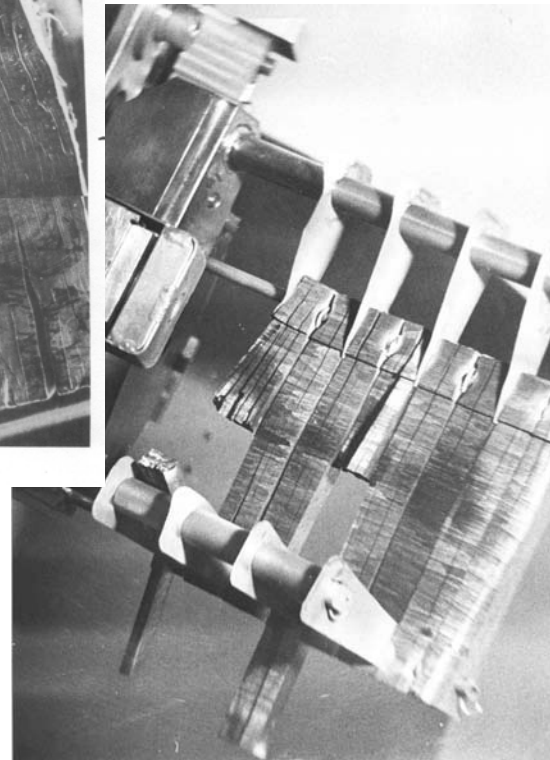

BNL

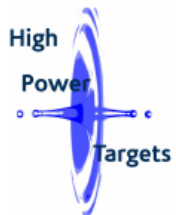
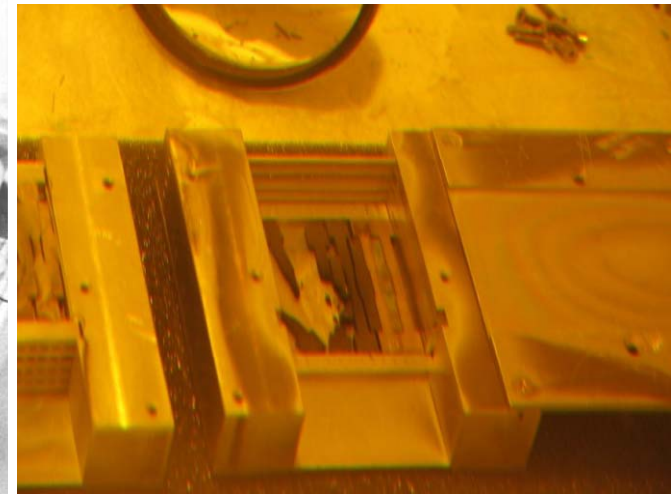

Chris Densham

# Target technology progression:

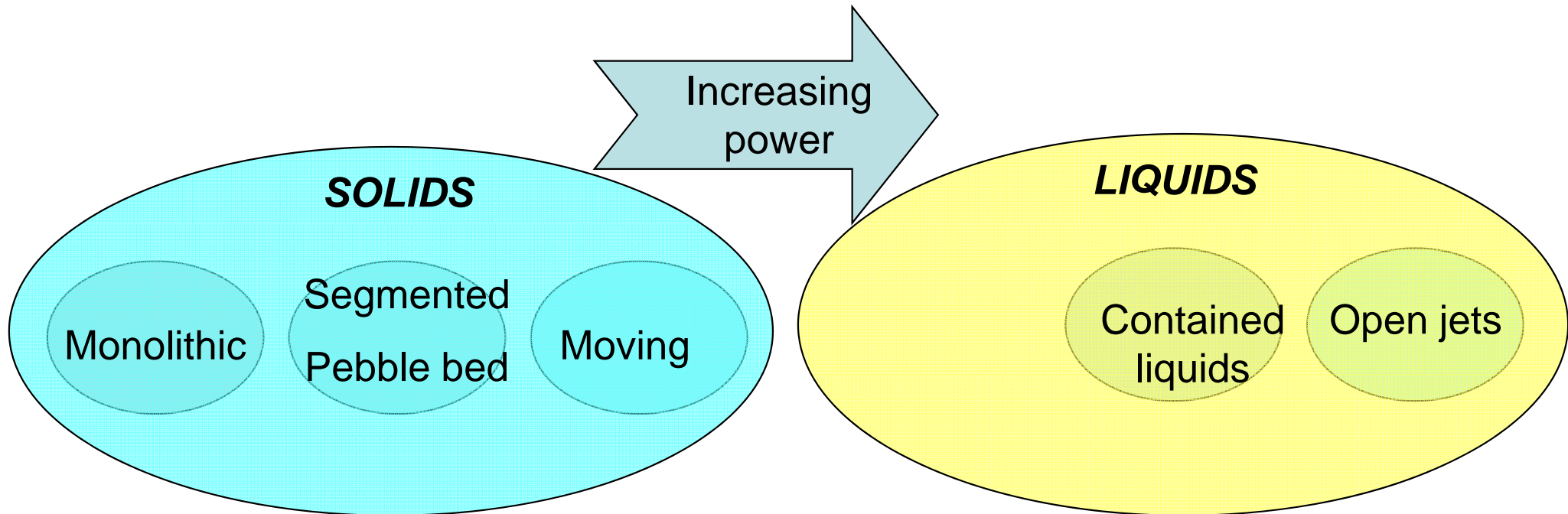

## Challenges:

Power dissipation,  
Radiation damage,  
Shock waves/  
thermal stress

Power limits,  
Low density

Cooling,  
Lubrication / tribology,  
Reliability

Shock waves,  
Cavitation  
Corrosion  
Radiochemistry

Splashing,  
radiochemistry,  
corrosion

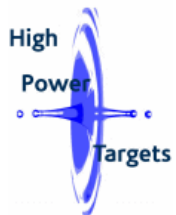

Chris Densham



Science & Technology Facilities Council  
Rutherford Appleton Laboratory

# Mercury jet target is 'already broken' - Neutrino Factory / Muon Collider baseline

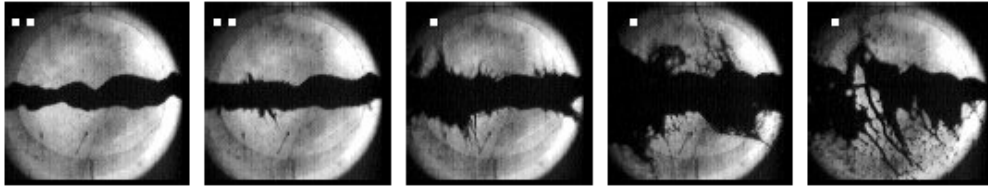

... pulsed beam 'splash' mitigated by solenoidal magnetic field (ref. MERIT talk by Kirk MacDonald)

ORNL/VG  
Mar2009

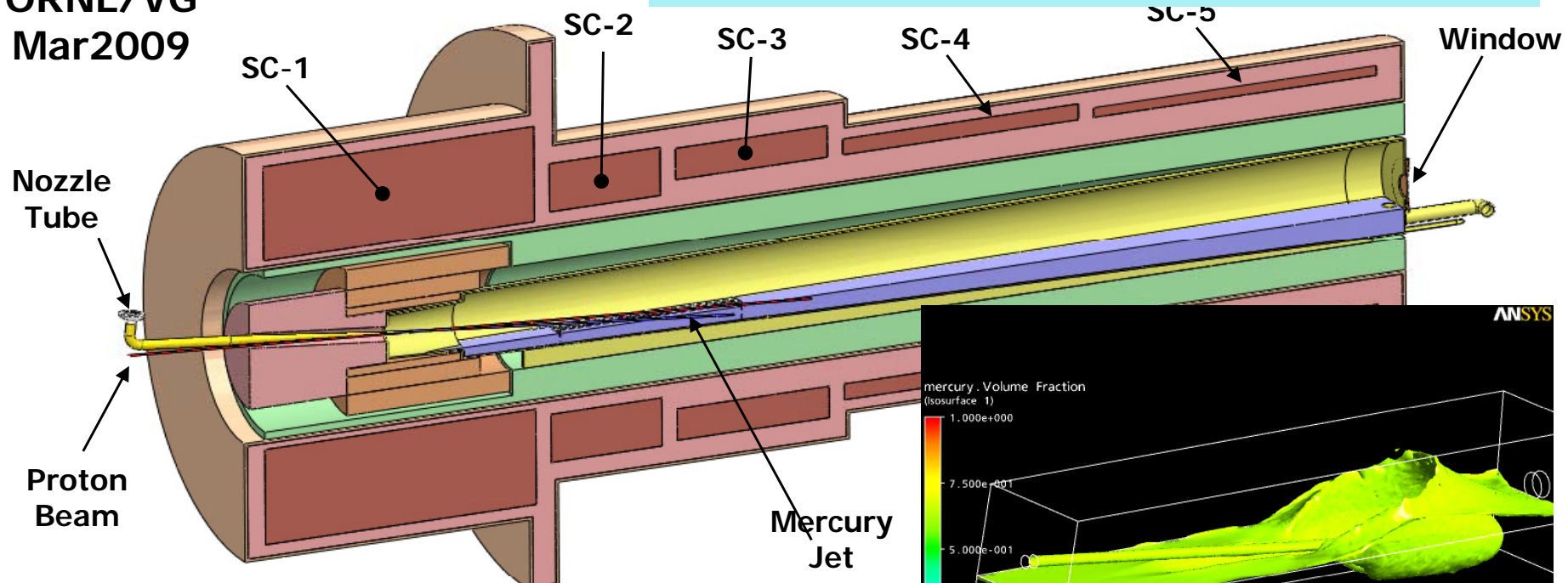

Some issues remain  
e.g. interaction of jet  
with mercury pool

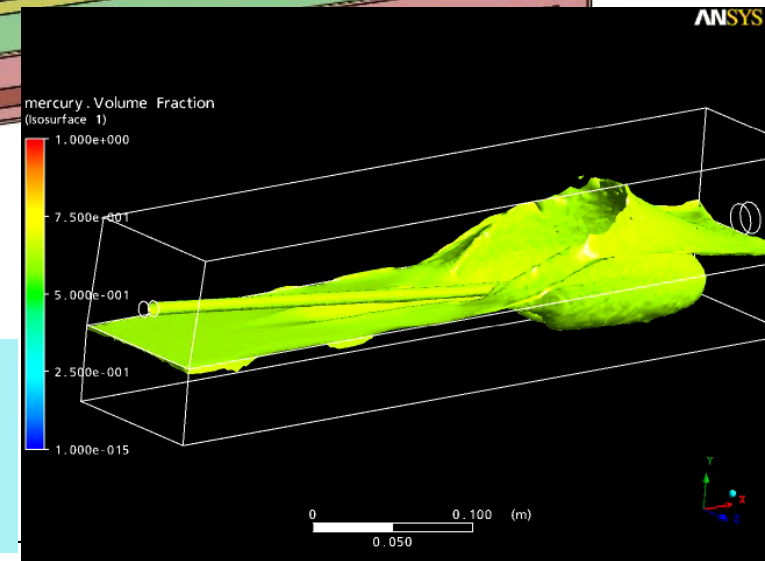

# Liquid metal jets with magnetic horns? Probably not...

2.2 GeV  
at 4MW  
50 Hz  
operation

Protons

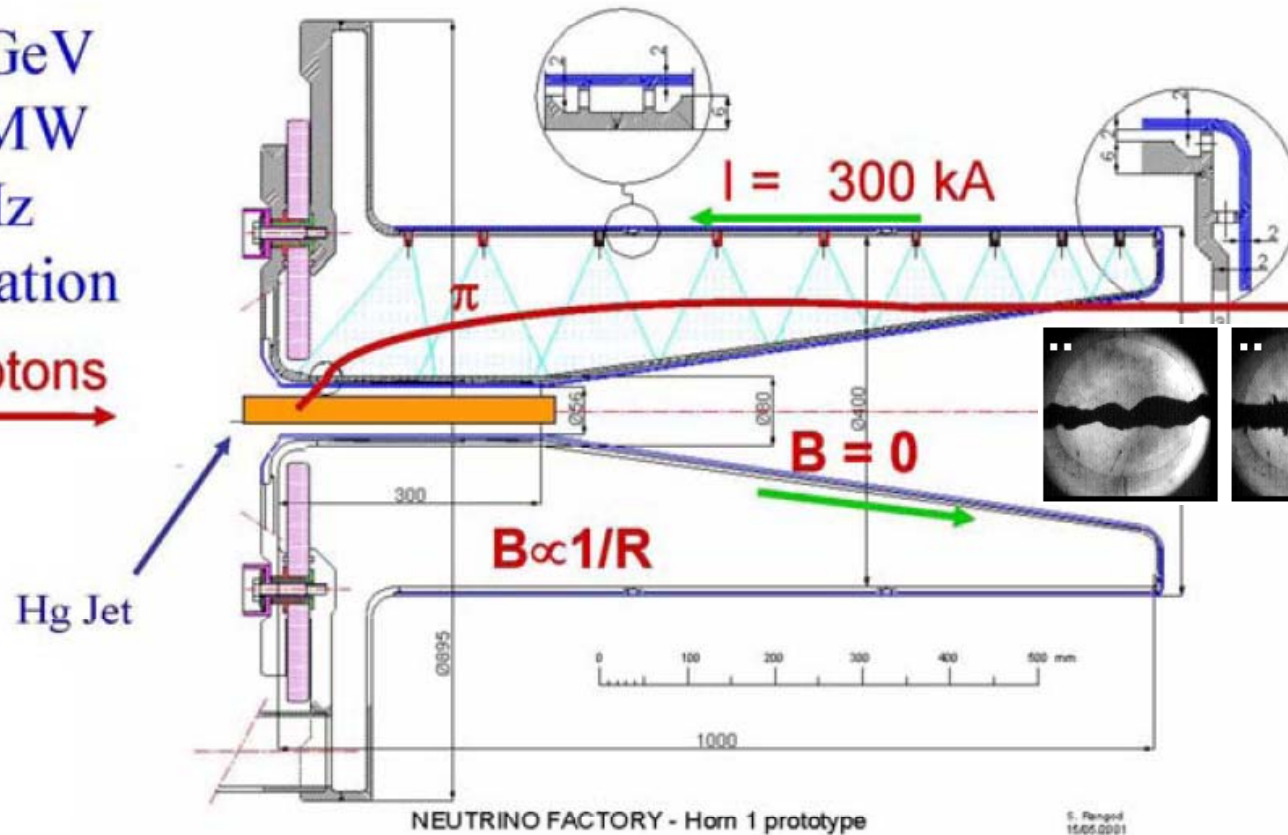

No magnetic field  
inside a magnetic  
horn, so  
no damping of  
splashes

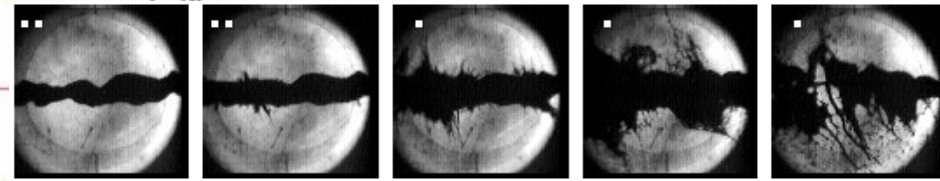

Cavitation Damage  
Erosion from SNS/JSNS  
research

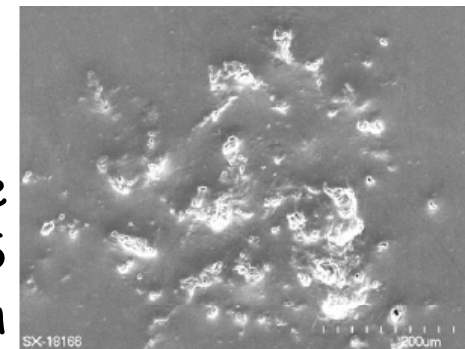

Chris Densham



Science & Technology Facilities Council  
Rutherford Appleton Laboratory

# Is there a 'missing link' target technology?

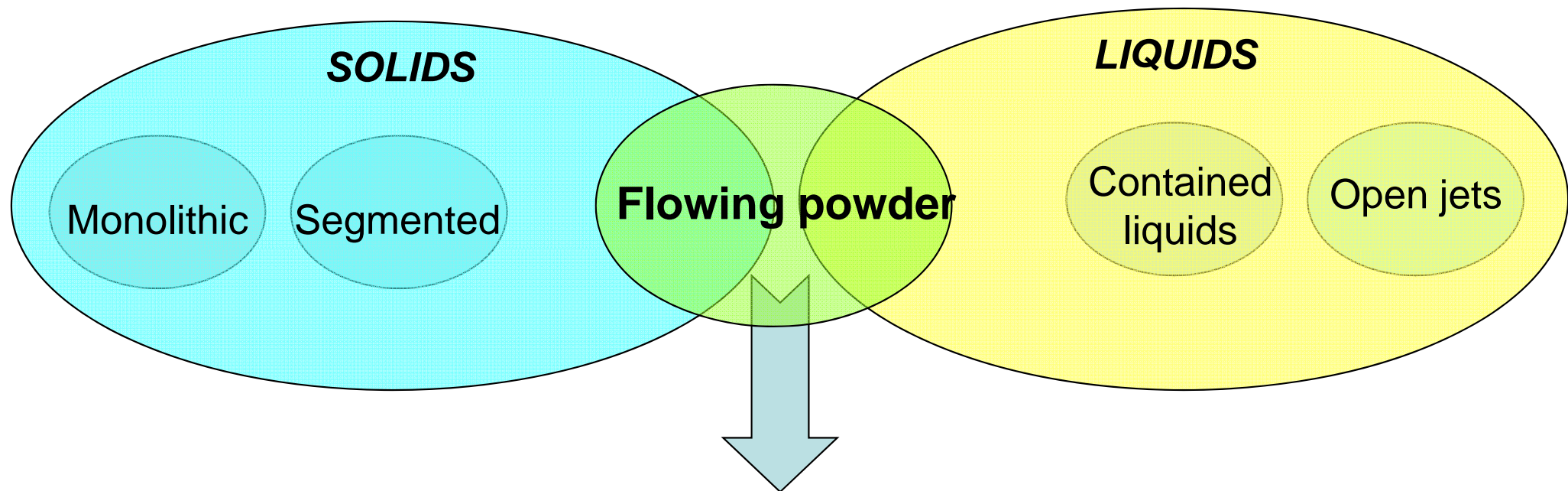



# Flowing powder targets: some potential advantages

- **Shock waves**
  - Material is already broken - intrinsically damage proof
  - No cavitation, splashing or jets as for liquids
  - high power densities can be absorbed without material damage
  - Shock waves constrained within material grains, c.f. sand bags used to absorb impact of bullets
- **Heat transfer**
  - High heat transfer both within bulk material and with pipe walls - so the bed can dissipate high energy densities, high total power, and multiple beam pulses
- **Quasi-liquid**
  - Target material continually reformed
  - Can be pumped away, cooled externally & re-circulated
  - Material easily replenished
- **Other**
  - Can exclude moving parts from beam interaction area
  - Low eddy currents i.e. low interaction with NF solenoid field
  - Fluidised beds/jets are a mature technology
  - Most issues of concern can be tested off-line i.e. cheaply!

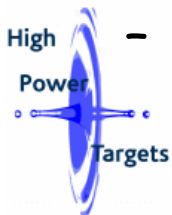

Chris Densham



Science & Technology Facilities Council  
Rutherford Appleton Laboratory

# Schematic layouts of flowing powder targets for neutrino facilities

**Superbeam target - contained within pipe**

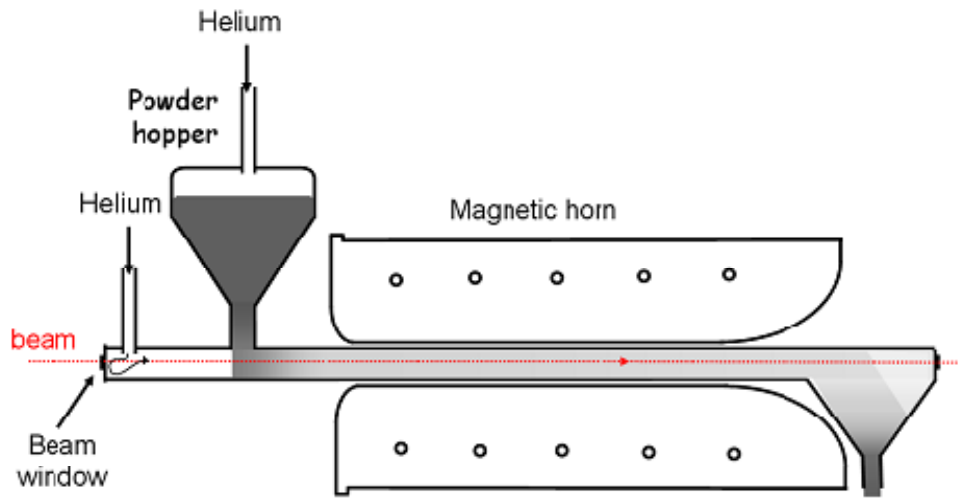

**Neutrino factory target - open jet configuration used in test rig on day 1**

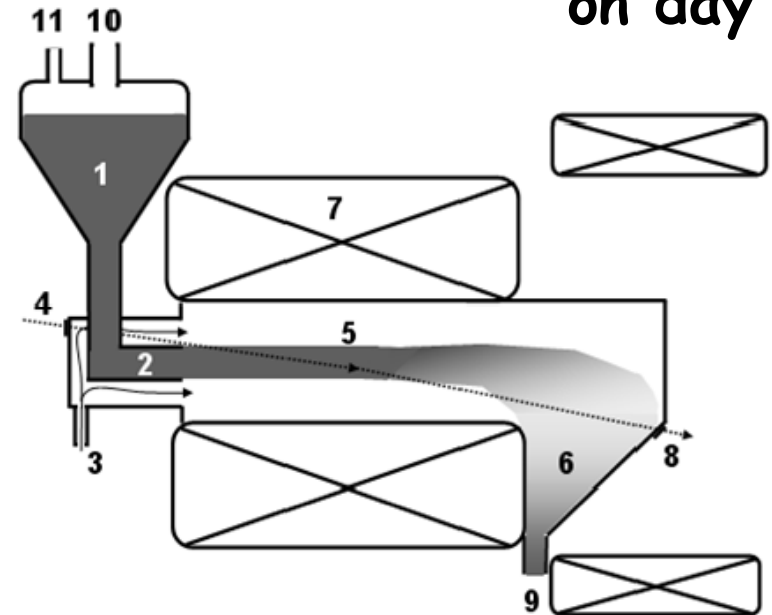

(1) pressurised powder hopper, (2) discharge nozzle, (3) recirculating helium to form coaxial flow around jet, (4) proton beam entry window, (5) open jet interaction region, (6) receiver, (7) pion capture solenoid, (8) beam exit window, (9) powder exit for recirculation, (10) return line for powder to hopper, (11) driver gas line

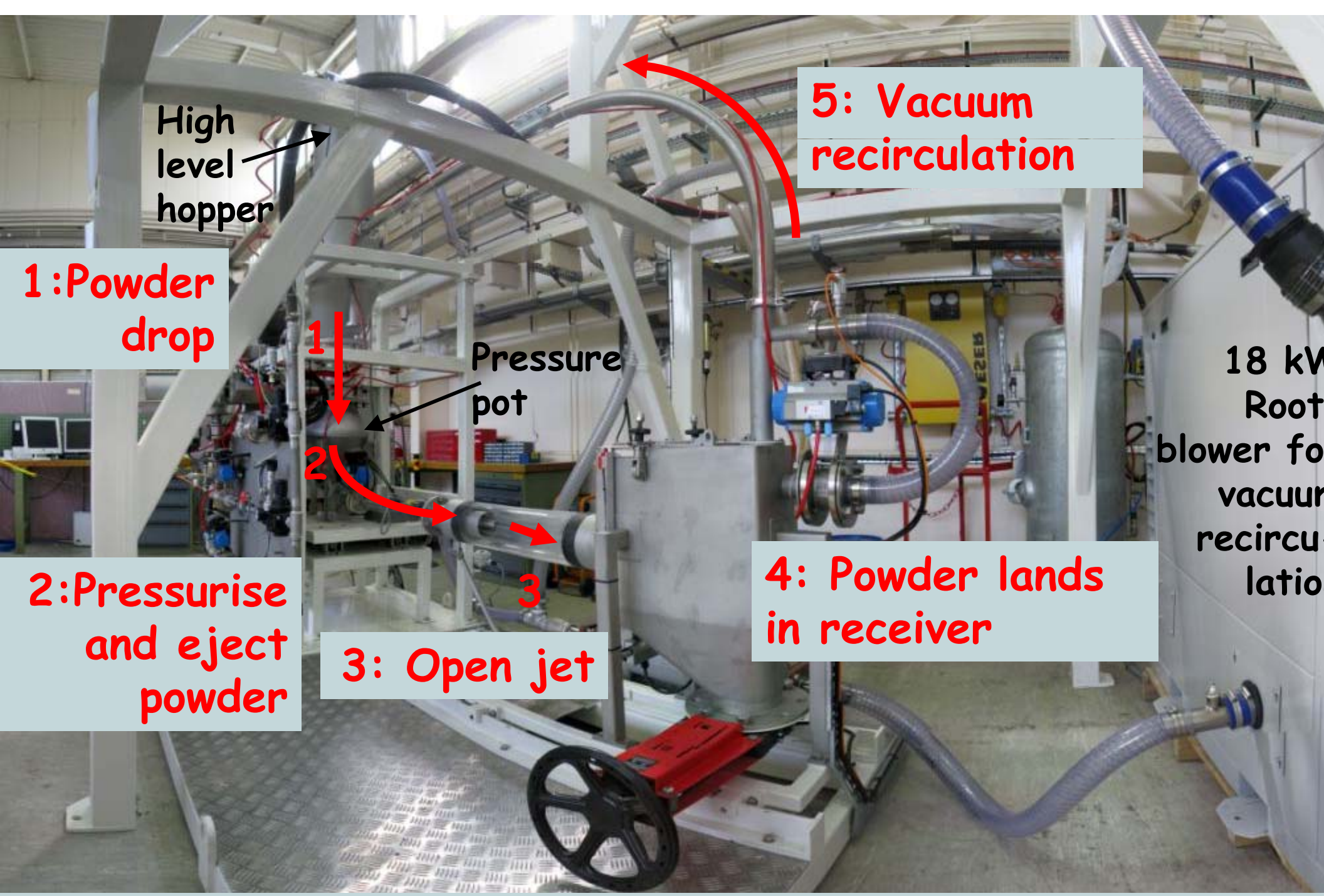

High level hopper

1: Powder drop

1  
2

Pressure pot

2: Pressurise and eject powder

3: Open jet

3

4: Powder lands in receiver

5: Vacuum recirculation

18 kW Root blower for vacuum recirculation

Powder test rig: open jet configuration

# Overview of Powder Test Rig operation

- Powder recirculated in "Batch" mode
  - Rig contains ~130 kg Tungsten Powder
  - Discharge pipe ~20 mm diameter x 1 m long
  - Particle size < 250 microns
- Fully automated control system
  - Valve open/close sequence
  - Blower on/off
  - Blower Frequency
  - Data Logging
  - Hard-wired safety interlocks

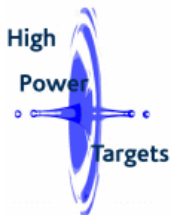

Chris Densham



Science & Technology Facilities Council  
Rutherford Appleton Laboratory

# GUI for Powder plant Control System

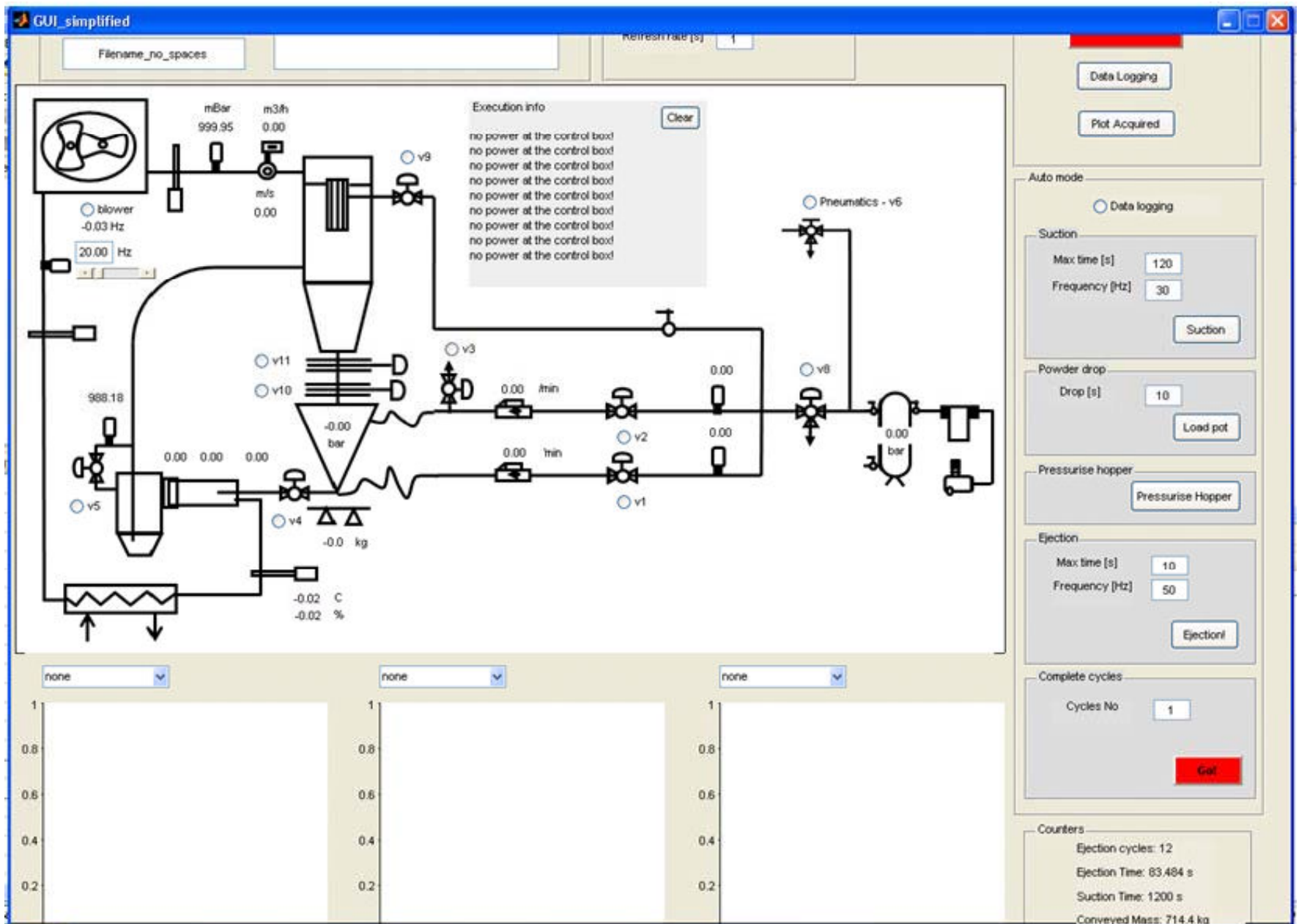

Chris Densham

# First data runs in March 2009

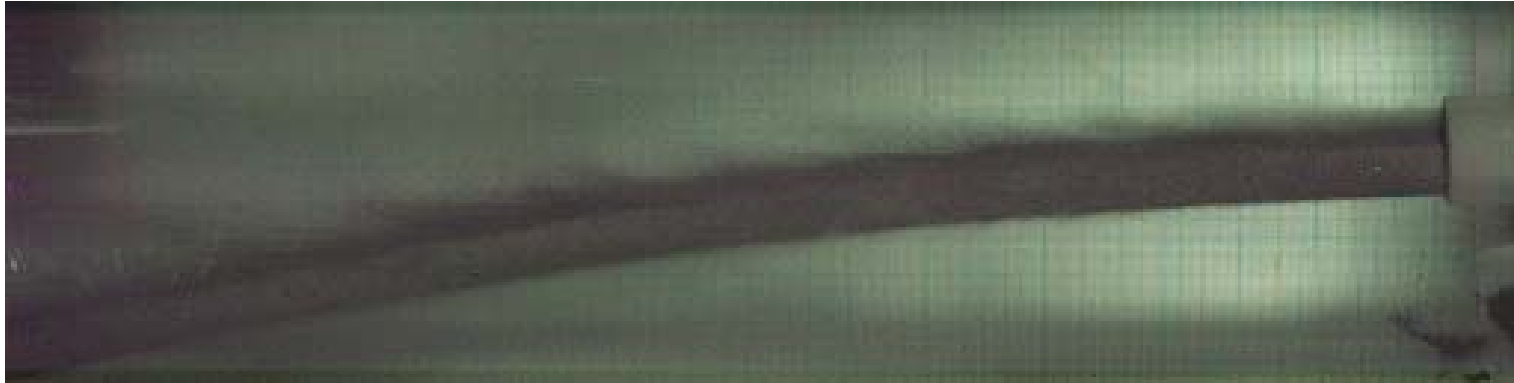

- 31 injection cycles - 3000 kg powder re-circulated
  - Driving pressure range 2 - 5 bar
- Best quality jet obtained for 2 bar driving pressure
  - Jet Velocity = 3.7 m/s
  - Stable Jet
    - Constant pressure in hopper throughout ejection
    - Constant velocity (top/bottom and over time)
    - Constant dimensions (with distance from nozzle and time)
- Jet material fraction = 42% ± 5% ~ bulk powder density at rest

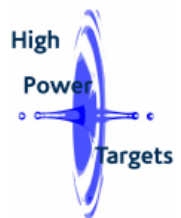
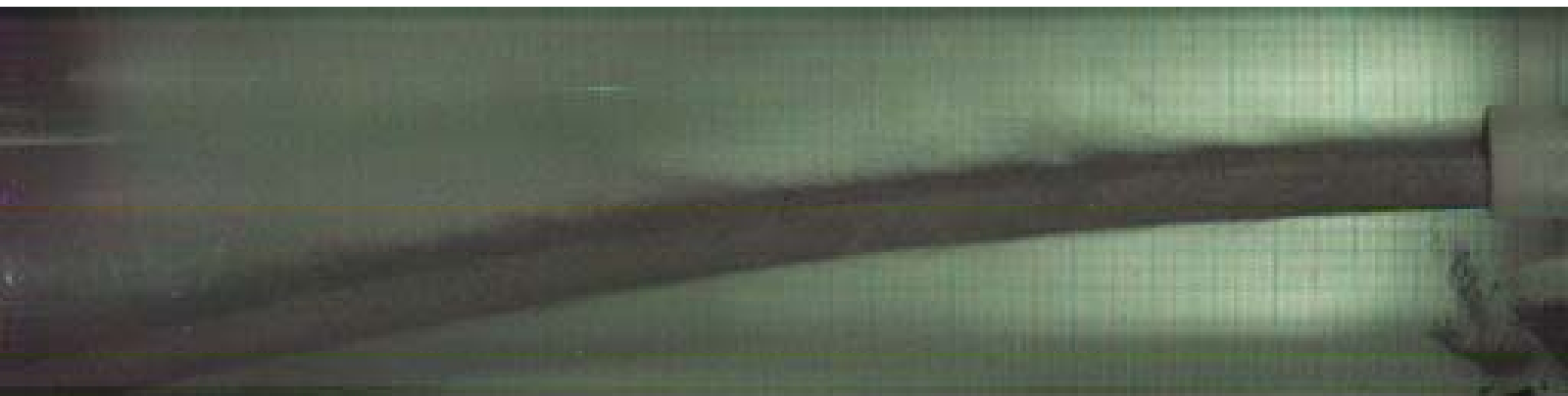

Chris Densham



Science & Technology Facilities Council  
Rutherford Appleton Laboratory

# CW operation: schematic circuit outline

- (1) powder discharge nozzle
- (2) gas return line forming coaxial flow
- (3) target jet,
- (4) receiver hopper
- (5) suction nozzle for gas lift
- (6) gas lift receiver vessel with filter
- (7) powder heat exchanger
- (8) and (9) pressurised powder hoppers
- (10) Roots blower
- (11) gas heat exchanger
- (12) compressor
- (13) gas reservoir

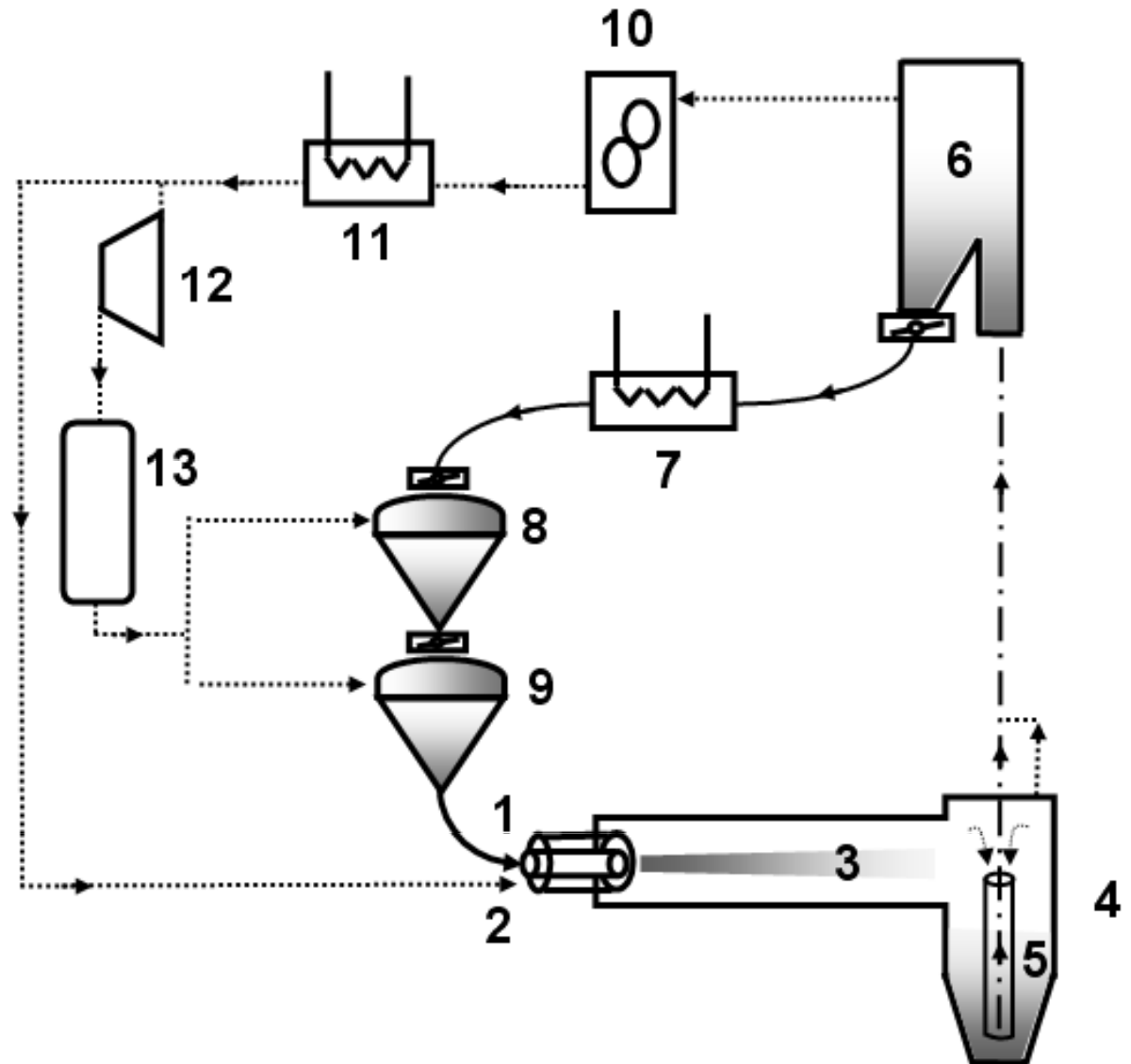



# Flowing powder target: future work

- Optimise gas lift system
- Carry out long term erosion tests and study mitigation
- Investigate low-flow limit
- Study heat transfer between pipe wall and powder
- Demonstrate shock waves are not a problem
  - Possibility to use test facility for shock wave experiment on a powder sample in helium environment?
- Demonstrate magnetic fields/eddy currents are not a problem
  - Use of high field solenoid?
- Investigate active powder handling issues (cf mercury?)



# Flowing powder target: interim conclusions

- Flowability of tungsten powder
  - Excellent flow characteristics within pipes
  - Can form coherent, stable, dense open jet
  - Density fraction of  $42\% \pm 5\%$  achieved  $\sim$  static bulk powder density
- Recirculation
  - Gas lift works for tungsten powder (though so far 10 x slower than discharge rate)
- Both contained and open powder jets are feasible



Chris Densham



Science & Technology Facilities Council  
Rutherford Appleton Laboratory