

# A Neutrino Factory

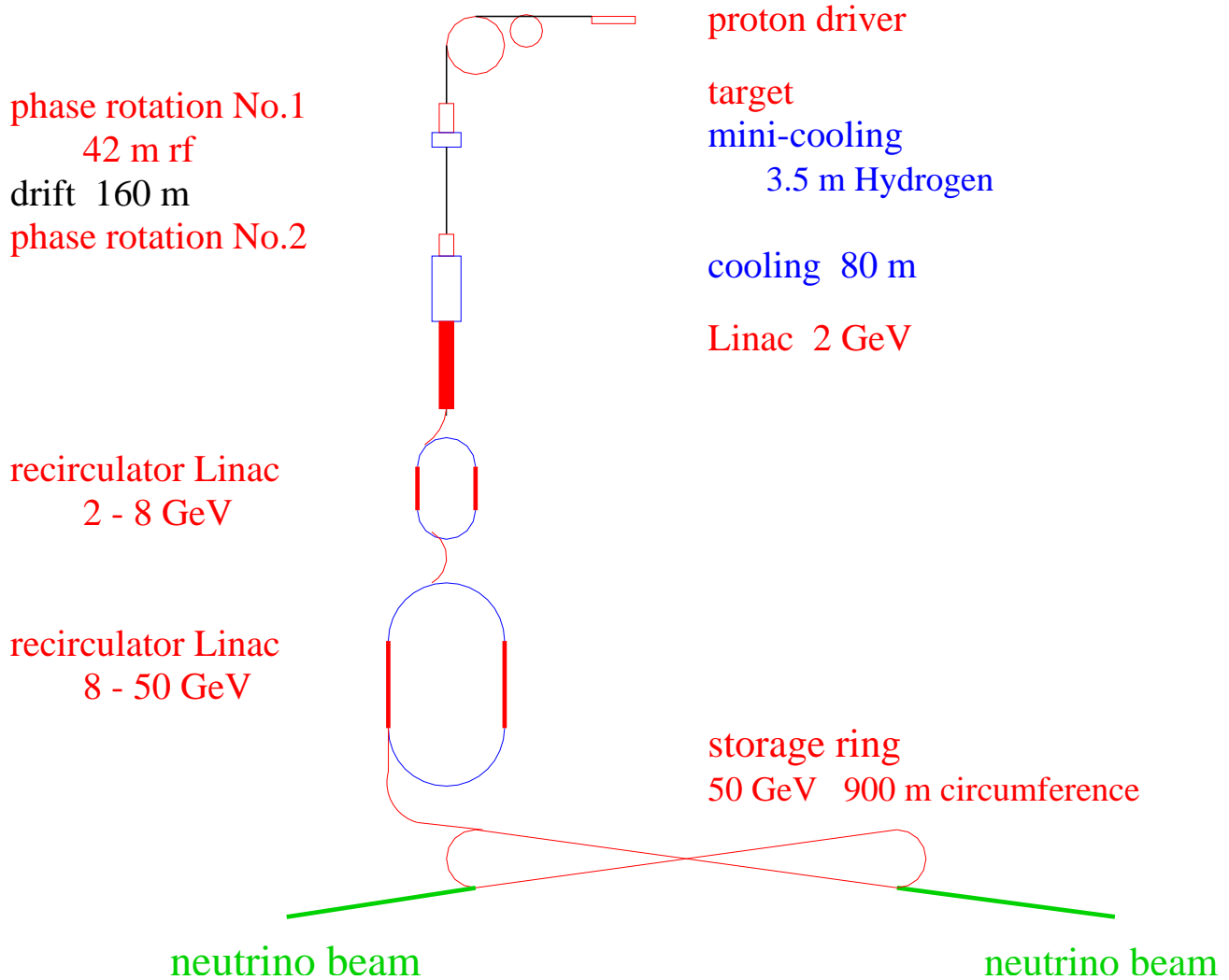

Kirk T. McDonald

*Princeton U.*

[mcdonald@puphep.princeton.edu](mailto:mcdonald@puphep.princeton.edu)

*Physics Colloquium at New York University*

February 24, 2000

<http://puhep1.princeton.edu/~mcdonald/nufact/>

## *Neutrinos*, by John Updike

Neutrinos: they are very small  
They have no charge; they have no mass;  
They do not interact at all.  
The Earth is just a silly ball  
To them, through which they simply pass  
Like dustmaids down a drafty hall  
Or photons through a sheet of glass.  
They snub the most exquisite gas,  
Ignore the most substantial wall,  
Cold shoulder steel and sounding brass,  
Insult the stallion in his stall,  
And, scorning barriers of class,  
Infiltrate you and me. Like tall  
And painless guillotines they fall  
Down through our heads into the grass.  
At night, they enter at Nepal  
And pierce the lover and his lass  
From underneath the bed. You call  
It wonderful; I call it crass.

## A Century of Neutrinos

- 1896 – Bequerel discovers radioactivity of uranium salts.
- 1899 – Rutherford identifies  $\alpha$  and  $\beta$  radioactivity.
- 1914-1927 – Chadwick: the  $\beta$  energy spectrum is continuous.
- 1933 – Pauli:  $\beta$  decay involves a neutrino,  $n \rightarrow p + e + \bar{\nu}_e$ .
- 1934 – Fermi: theory of  $\beta$  decay with very light neutrinos.
- 1956 – Cowan and Reines detect the  $\bar{\nu}_e$  via  $\bar{\nu}_e + p \rightarrow e^+ + n$ .
- 1957 – Pontecorvo:  $\nu_e$  could oscillate into  $\nu_\mu$ .
- 1962 – Lederman, Schwartz and Steinberger detect the  $\nu_\mu$ .
- 1968 – Davis reports the first solar neutrino ( $\nu_e$ ) “deficit”.
- 1976 – Perl *et al.* discover the  $\tau$  lepton;  $\nu_\tau$  is presumed to exist.
- 1990 –  $\Gamma_{Z^0}$  measured at LEP,  $\Rightarrow$  only 3 light, SM neutrinos.
- 1998 – Superkamiokande:  $\nu_\mu$ 's disappear over Earth distances.
- 1998 onwards – Proposals for a neutrino factory.

# Oscillations of Massive Neutrinos

Neutrinos could have a small mass (Pauli, Fermi, Majorana, 1930's).

Massive neutrinos can mix (Pontecorvo, 1957).

In the example of only two massive neutrinos (that don't decay), with mass eigenstates  $\nu_1$  and  $\nu_2$  with mass difference  $\Delta m$  and mixing angle  $\theta$ , the flavor eigenstates  $\nu_a$  and  $\nu_b$  are related by

$$\begin{pmatrix} \nu_a \\ \nu_b \end{pmatrix} = \begin{pmatrix} \cos \theta & \sin \theta \\ -\sin \theta & \cos \theta \end{pmatrix} \begin{pmatrix} \nu_1 \\ \nu_2 \end{pmatrix}.$$

The probability that a neutrino of flavor  $\nu_a$  and energy  $E$  appears as flavor  $\nu_b$  after traversing distance  $L$  in vacuum is

$$P(\nu_a \rightarrow \nu_b) = \sin^2 2\theta \sin^2 \left( \frac{1.27 \Delta m^2 [\text{eV}^2] L [\text{km}]}{E [\text{GeV}]} \right).$$

The probability that  $\nu_a$  does not disappear is

$$P(\nu_a \rightarrow \nu_a) = \cos^2 2\theta \sin^2 \left( \frac{1.27 \Delta m^2 [\text{eV}^2] L [\text{km}]}{E [\text{GeV}]} \right).$$

## A Sketch of Current Data

- The **Atmospheric Neutrino “Anomaly”** suggests that GeV  $\nu_\mu$ 's (from  $p+N_2 \rightarrow \pi \rightarrow \mu\nu_\mu$ ) disappear while traversing the Earth's diameter,  $\Rightarrow \Delta m^2 \approx 10^{-3} \text{ (eV)}^2$  for  $\sin^2 2\theta \approx 1$ . (Kamiokande, IMB, Soudan-2, MACRO, Super-Kamiokande)

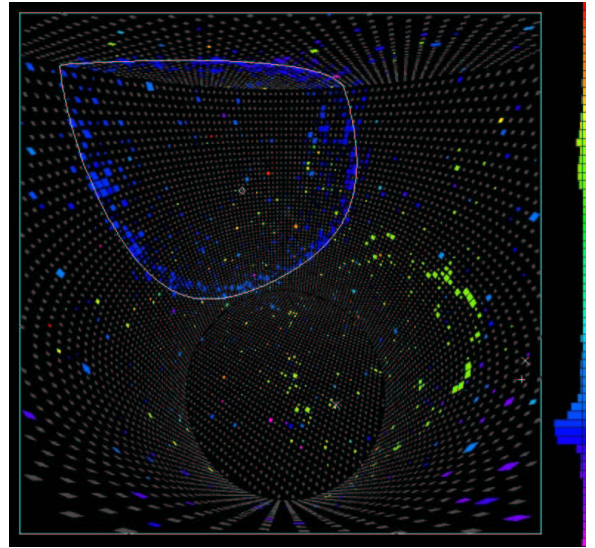
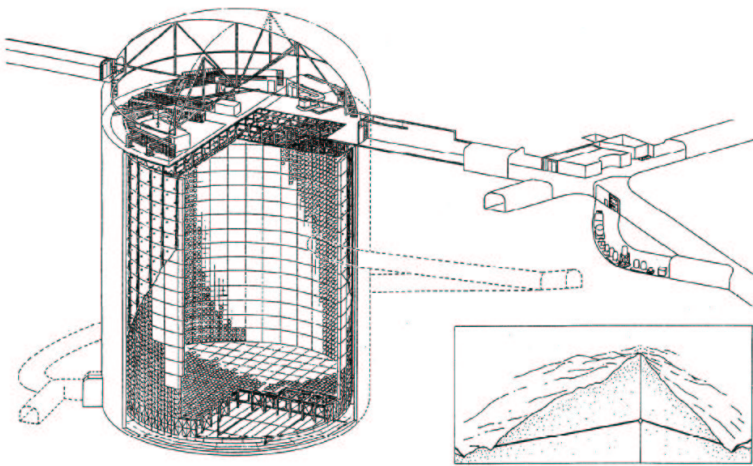

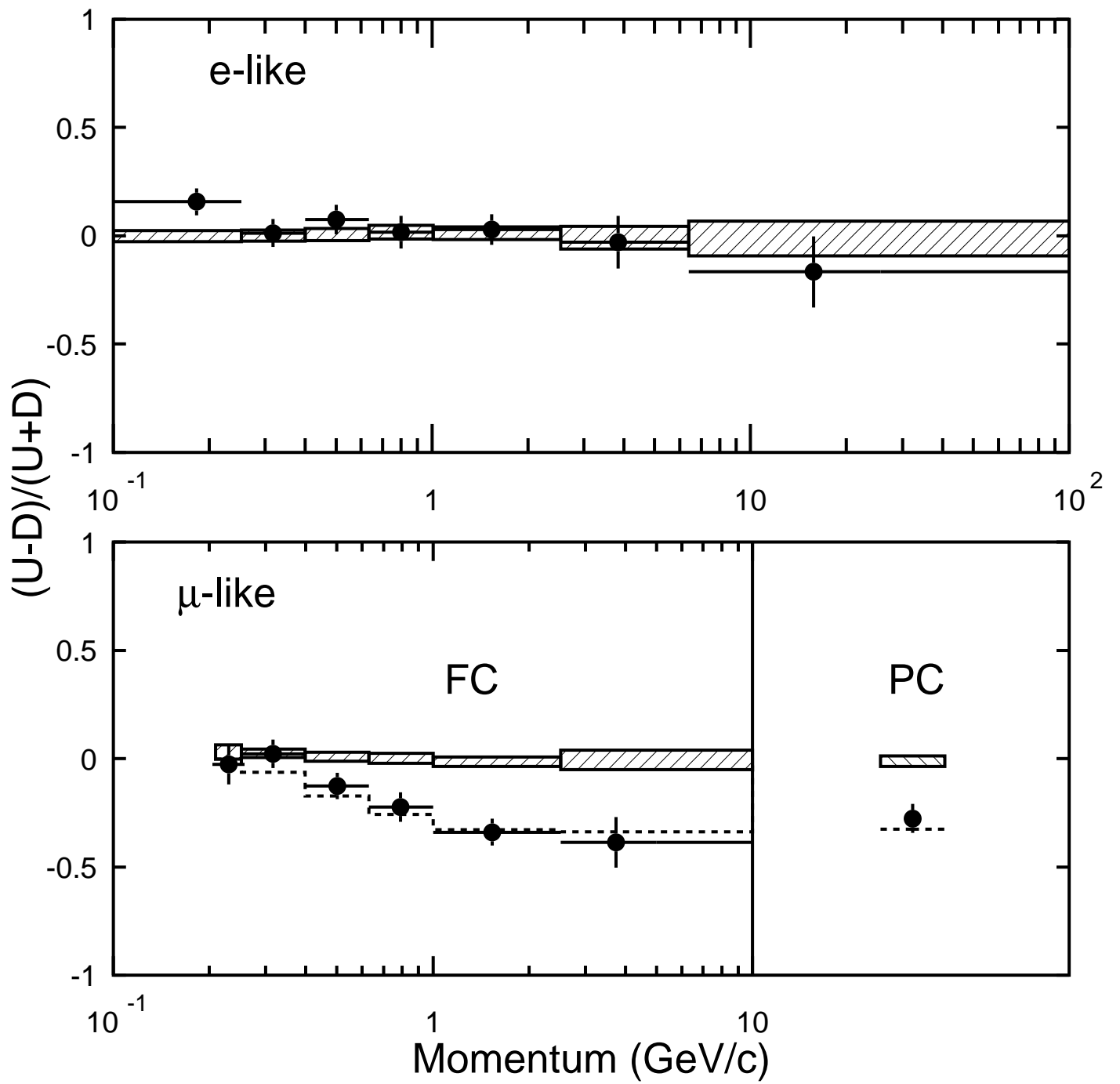

- The **Solar Neutrino “Deficit”** suggests that MeV  $\nu_e$ 's disappear between the center of the Sun and the Earth.  
 $\Rightarrow \Delta m^2 \approx 10^{-10} \text{ (eV)}^2$  for  $\sin^2 2\theta \approx 1$ , if vacuum oscillations.  
 (Homestake, Super-Kamiokande, GALLEX, SAGE)

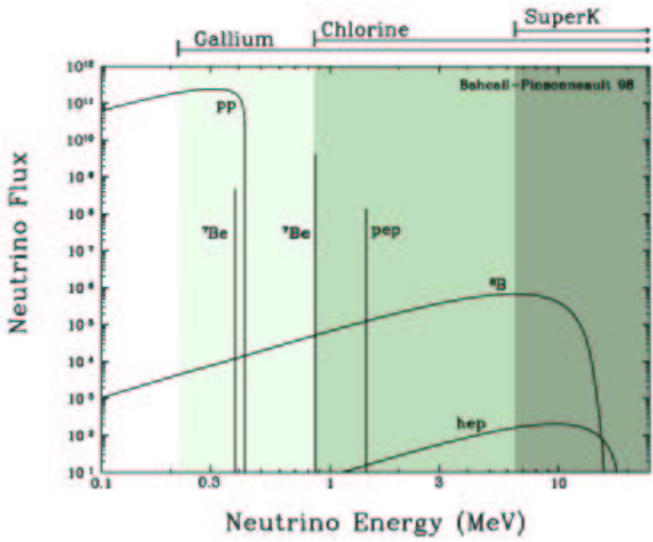

Total Rates: Standard Model vs. Experiment  
Bahcall-Pinsonneault 98

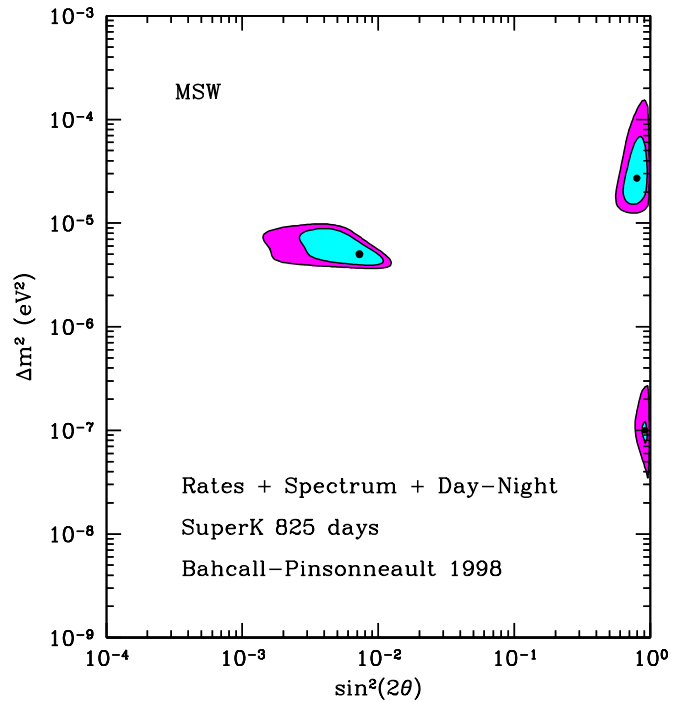
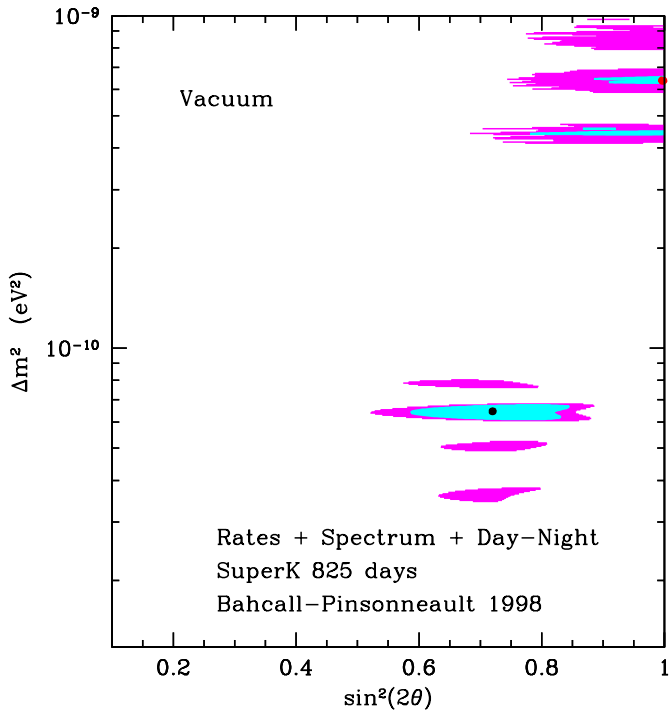
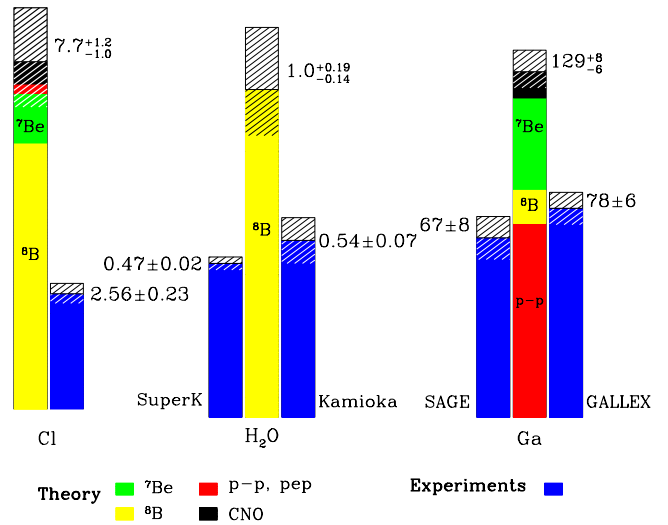

- The **LSND Experiment** suggests that 30-MeV  $\bar{\nu}_\mu$ 's (from  $p + \text{H}_2\text{O} \rightarrow \pi^- \rightarrow \mu^- \bar{\nu}_\mu$ ) appear as  $\bar{\nu}_e$ 's after 30 m.  $\Rightarrow \Delta m^2 \approx 1 \text{ (eV)}^2$ , but reactor data requires  $\sin^2 2\theta \lesssim 0.03$ .

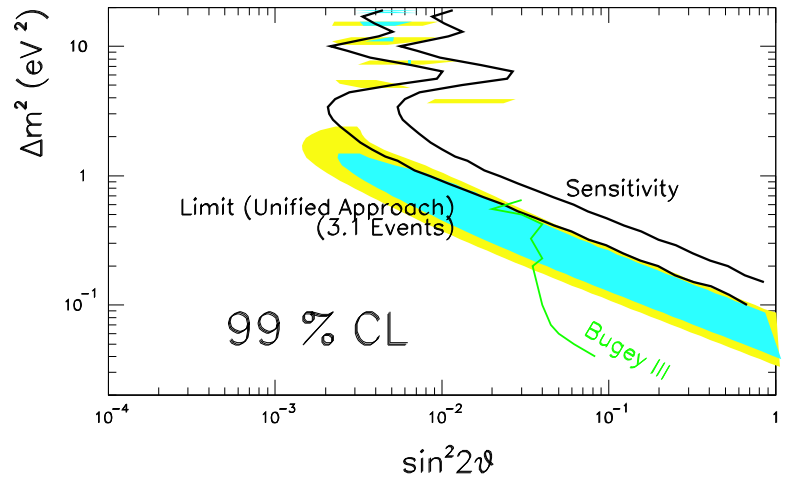
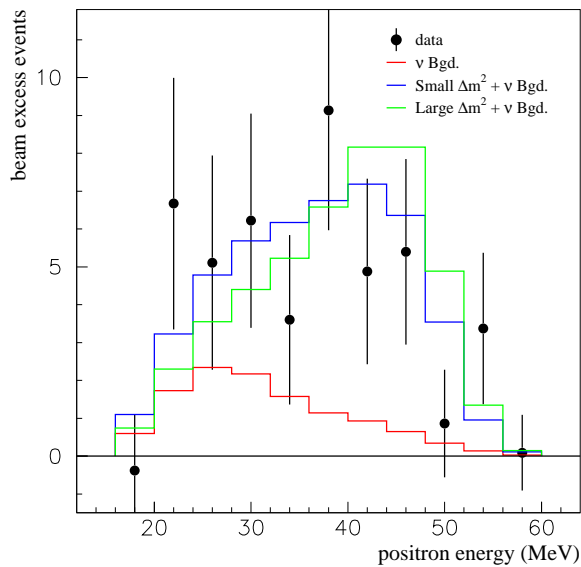
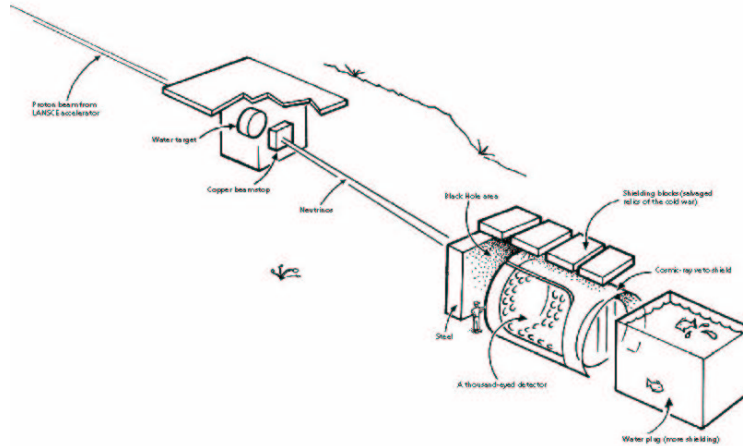

The atmospheric neutrino anomaly + the solar neutrino deficit (if both correct) require at least 3 massive neutrinos.

If LSND is correct as well, need at least 4 massive neutrinos.

The measured width of the  $Z^0$  boson (LEP)  $\Rightarrow$  only 3 Standard Model neutrinos. A 4th massive neutrino must be “sterile”.



## The Supersymmetric Seesaw

A provocative conjecture is that neutrino mass  $m_\nu$  is coupled to two other mass scales,  $m_I$  (intermediate) and  $m_H$  (heavy), according to

$$m_\nu = \frac{M_I^2}{M_H}.$$

(Gell-Mann, Ramond, Slansky, 1979)

A particularly suggestive variant takes  $m_I = \langle \phi_{\text{Higgs}} \rangle = 250 \text{ GeV}$ ;  
Then

$$m_\nu \approx \sqrt{\Delta m^2(\text{atmospheric})} \approx 0.06 \text{ eV} \Rightarrow m_H \approx 5 \times 10^{15} \text{ GeV}.$$

This is perhaps the best experimental evidence for a grand unification scale, such as that underlying supersymmetric SO(10) models.

[Others interpret the need for a mass scale beyond the electroweak scale ( $\approx 1 \text{ TeV}$ ) as suggesting there exist large extra dimensions.]

## Mixing of Three Neutrinos

$$\begin{pmatrix} \nu_e \\ \nu_\mu \\ \nu_\tau \end{pmatrix} = \begin{pmatrix} c_{12}c_{13} & s_{12}c_{13} & s_{13}e^{-i\delta} \\ -s_{12}c_{23} - c_{12}s_{13}s_{23}e^{i\delta} & c_{12}c_{23} - s_{12}s_{13}s_{23}e^{i\delta} & c_{13}s_{23} \\ s_{12}s_{23} - c_{12}s_{13}c_{23}e^{i\delta} & -c_{12}s_{23} - s_{12}s_{13}c_{23}e^{i\delta} & c_{13}c_{23} \end{pmatrix} \begin{pmatrix} \nu_1 \\ \nu_2 \\ \nu_3 \end{pmatrix}$$

where  $c_{12} = \cos \theta_{12}$ , *etc.* (Maki, Nakagawa, Sakata, 1962).

Three massive neutrinos  $\Rightarrow$  six independent parameters:

- Three mixing angles:  $\theta_{12}$ ,  $\theta_{13}$ ,  $\theta_{23}$ ,
- A phase  $\delta$  related to CP violation,
- Two differences of the squares of the neutrino masses.  
Ex:  $\Delta m_{12}^2 = \Delta m^2(\text{solar})$  and  $\Delta m_{23}^2 = \Delta m^2(\text{atmospheric})$ .
- [ $J_{CP} = s_{12}s_{23}s_{31}c_{12}c_{23}c_{31}^2s_\delta = \text{Jarlskog invariant}$ .]

Measurement of these parameters is a primary goal of experimental neutrino physics.

If four massive neutrinos, then 6 mixing angles, 3 phases,  
3 independent squares of mass differences.

[The MNS neutrino mixing matrix is more provocative than the CKM quark matrix; if 2 of 3 mixing angles are near  $45^\circ$  ( $\Rightarrow$  “bimaximal” mixing), there is likely an associated symmetry.]

## Matter Effects

$\nu_e$ 's can interact with electrons via both  $W$  and  $Z^0$  exchanges, but other neutrinos can only interact with  $e$ 's via  $Z^0$  exchange.

$$\Rightarrow \sin^2 2\theta_{\text{matter}} = \frac{\sin^2 2\theta_{\text{vac}}}{\sin^2 2\theta_{\text{vac}} + (\cos 2\theta_{\text{vac}} - A)^2},$$

where  $A = 2\sqrt{2}G_F N_e E / \Delta m^2$  depends on sign of  $\Delta m^2$ .

At the “resonance”,  $\cos 2\theta_{\text{vac}} = A$ ,  $\sin^2 2\theta_{\text{matter}} = 1$  even if  $\sin^2 2\theta_{\text{vac}}$  is small (Wolfenstein, 1978, Mikheyev, Smirnov, 1986).

$\Rightarrow$  3 MSW solutions to the solar neutrino problem:

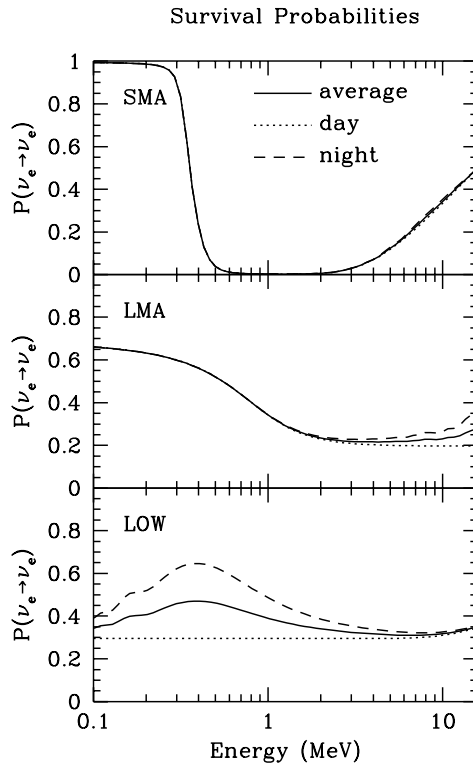

In any of these MSW solutions,  $\Delta m^2_{\text{solar}} > 0$ .

## Too Many Solutions

There are 8 scenarios suggested by present data:

- Either 3 or 4 massive neutrinos.
- Four solutions to the solar neutrino problem:
  1. Vacuum oscillation (VO, or “Just So”) solution;  
 $\Delta m_{12}^2 \approx (0.5 - 5.0) \times 10^{-10} \text{ eV}^2$ ,  $\sin^2 2\theta_{12} \approx (0.7 - 1.0)$ .
  2. Low MSW solution;  
 $\Delta m_{12}^2 \approx (0.5 - 2.0) \times 10^{-7} \text{ eV}^2$ ,  $\sin^2 2\theta_{12} \approx (0.9 - 1.0)$ .
  3. Small mixing angle (SMA) MSW solution;  
 $\Delta m_{12}^2 \approx (4.0 - 9.0) \times 10^{-6} \text{ eV}^2$ ,  $\sin^2 2\theta_{12} \approx (0.001 - 0.01)$ .
  4. Large mixing angle (LMA) MSW solution;  
 $\Delta m_{12}^2 \approx (0.2 - 2.0) \times 10^{-4} \text{ eV}^2$ ,  $\sin^2 \theta_{12} \approx (0.65 - 0.96)$ .
- Atmospheric neutrino data  $\Rightarrow \Delta m_{23}^2 \approx (3 - 5) \times 10^{-4} \text{ eV}^2$ ,  $\sin^2 \theta_{12} > 0.8$ .
- $\theta_{13}$  very poorly known;  $\delta$  completely unknown.

# Neutrino Oscillations

## Objective Reality or Social Construct?

Other than in the study of atmospheric neutrinos, experiments report a single data point, and conclude that disagreement between data and expectations are due to “oscillations”.

For more understanding, we need more data!

## The Next Generation of Neutrino Experiments

- Short baseline accelerator experiments (miniBoone, ORLAND, CERN) will likely clarify the LSND result.
- Super-Kamiokande + new long baseline accelerator experiments (K2K, Minos, NGS) will firm up measurements of  $\theta_{23}$  and  $\Delta m_{23}^2$ , but will provide little information on  $\theta_{13}$  and  $\delta$ .
- New solar neutrino experiments (BOREXino, SNO, HELLAZ, HERON, ....) will explore different portions of the energy spectrum, and clarify possible pathlength-dependent effects. SNO should provide independent confirmation of neutrino oscillations via comparison of reactions  $\nu + {}^2\text{H} \rightarrow p + p + e$  and  $\nu + {}^2\text{H} \rightarrow p + n + \nu$ .
- Each of these experiments studies oscillations of only a single pair of neutrinos.
- The continued search for the neutrinoless double-beta decay  ${}^{78}\text{Ge} \rightarrow {}^{78}\text{Se} + 2e^-$  will improve the mass limits on Majorana neutrinos to perhaps as low as 0.01 eV (hep-ex/9907040).

# The Opportunity for a Neutrino Factory

- Many of the neutrino oscillation solutions permit study of the couplings between 2, 3, and 4 neutrinos in accelerator based experiments.
- More neutrinos are needed!
- Present neutrino beams come from  $\pi, K \rightarrow \mu\nu_\mu$  with small admixtures of  $\bar{\nu}_\mu$  and  $\nu_e$  from  $\mu$  and  $K \rightarrow 3\pi$  decays.

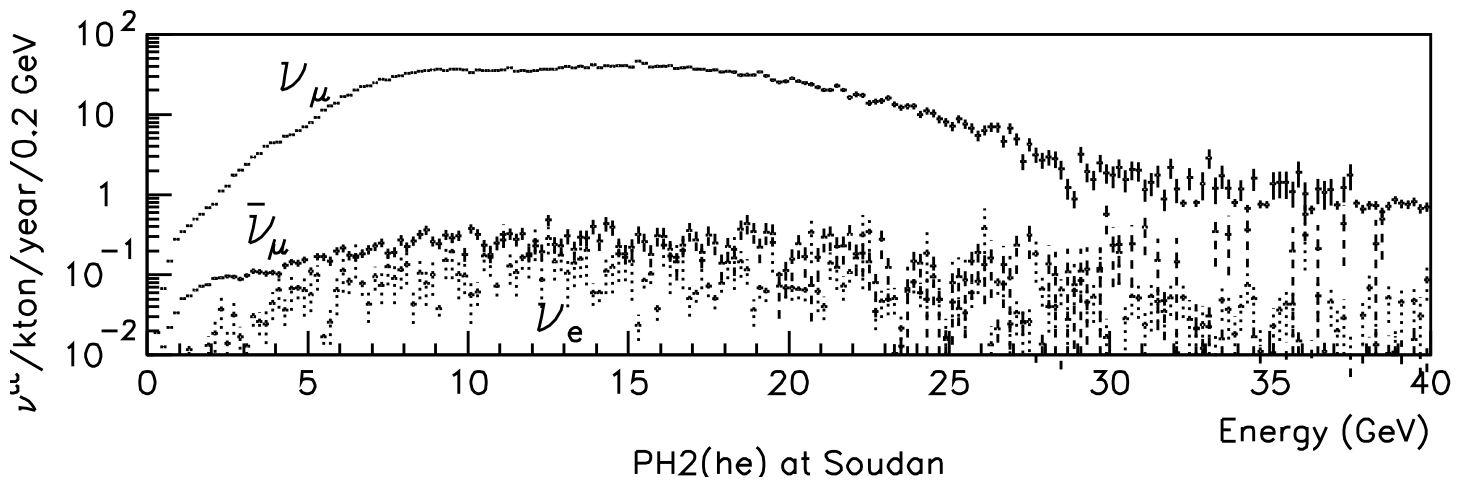
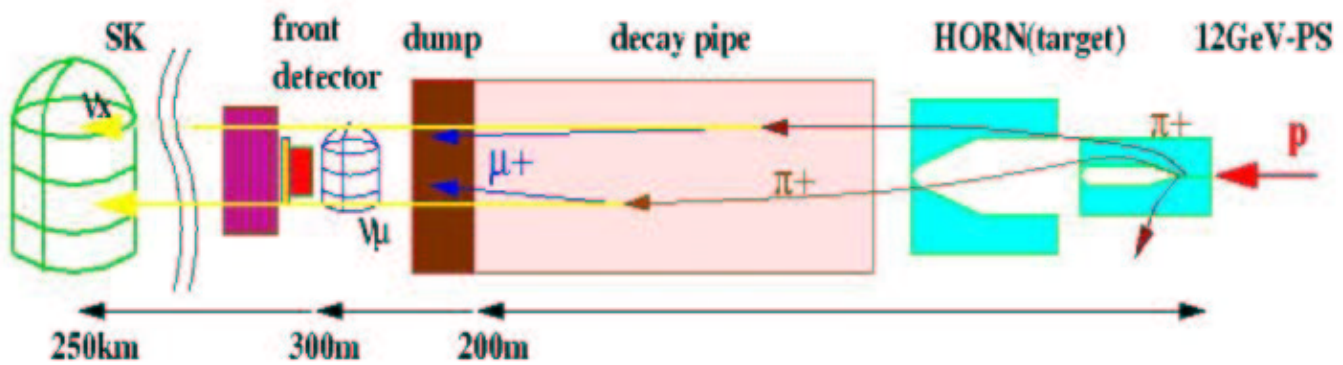

- Cleaner spectra and comparable fluxes of  $\nu_e$  and  $\nu_\mu$  desirable.

# A Neutrino Factory based on a Muon Storage Ring

- Higher (per proton beam power) and better characterized, neutrino fluxes are obtained from  $\mu$  decay.
- Collect low-energy  $\mu$ 's from  $\pi$  decay,  
Cool the muon bunch,  
Accelerate the  $\mu$ 's to the desired energy,  
Store them in a ring while they decay via  $\mu^- \rightarrow e^- \nu_\mu \bar{\nu}_e$ .  
[Of course, can use  $\mu^+$  also.]

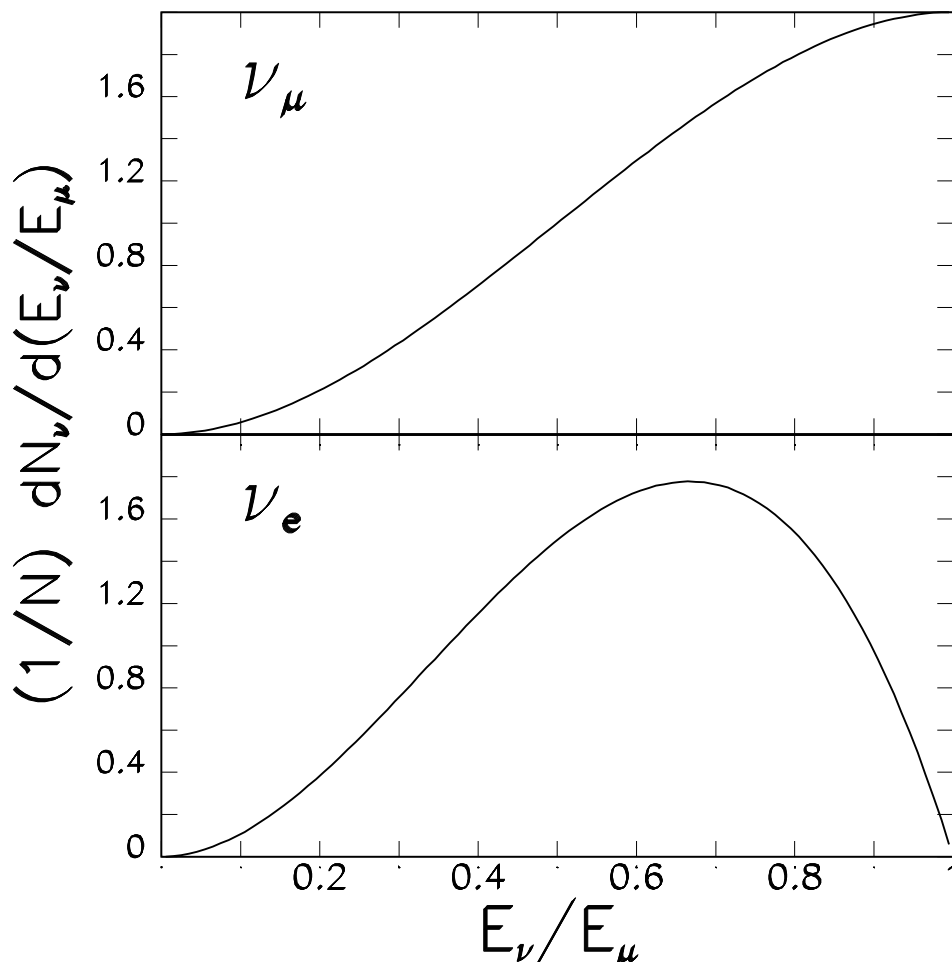



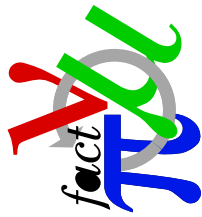

A Neutrino Factory  
based on a  
Muon Storage Ring

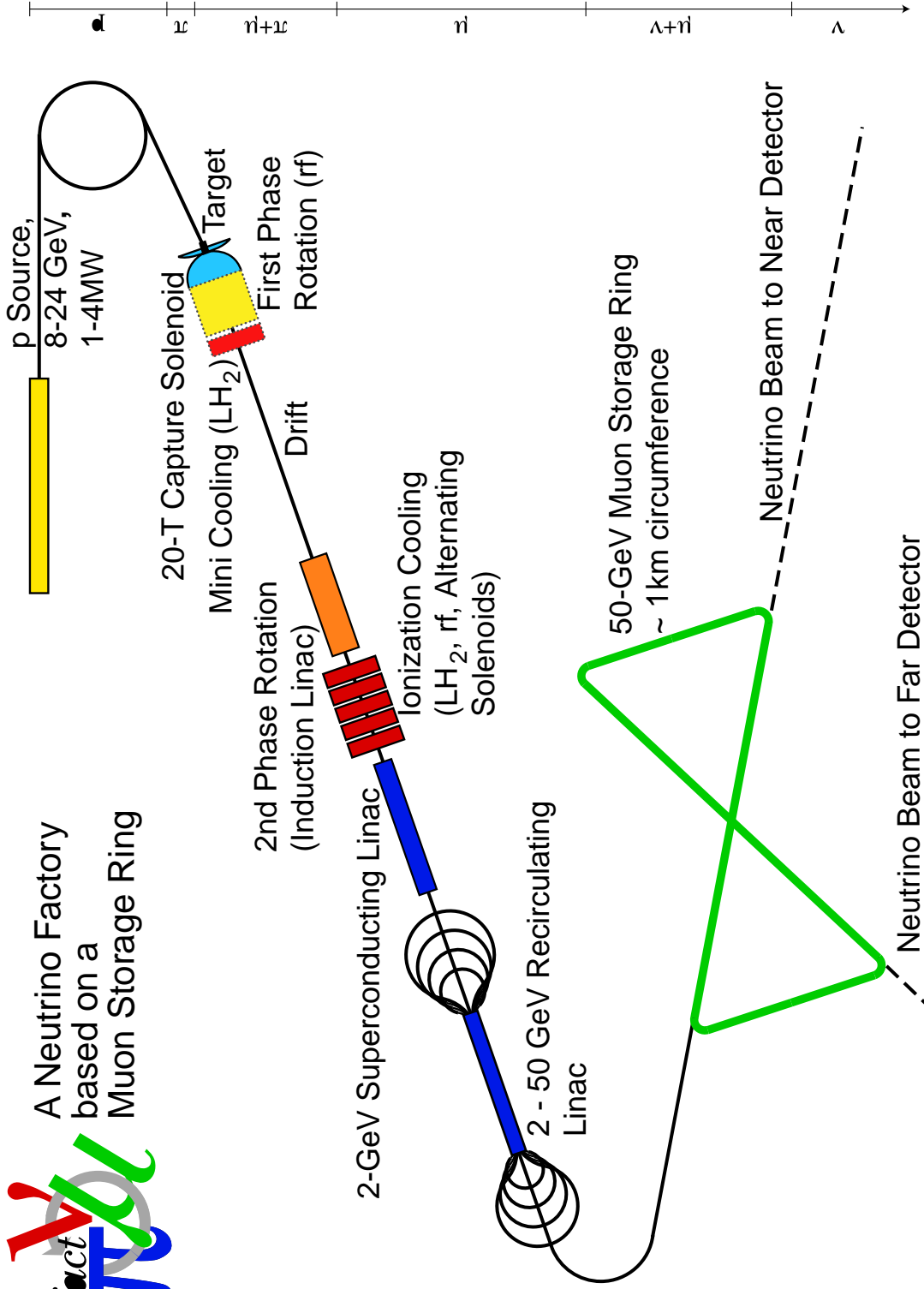

99 12 10 • Peter Gruber, CERN PS

## 6 Classes of Experiments at a Neutrino Factory

$$\nu_\mu \rightarrow \nu_e \rightarrow e^- \quad (\text{appearance}), \quad (1)$$

$$\nu_\mu \rightarrow \nu_\mu \rightarrow \mu^- \quad (\text{disappearance}), \quad (2)$$

$$\nu_\mu \rightarrow \nu_\tau \rightarrow \tau^- \quad (\text{appearance}), \quad (3)$$

$$\bar{\nu}_e \rightarrow \bar{\nu}_e \rightarrow e^+ \quad (\text{disappearance}), \quad (4)$$

$$\bar{\nu}_e \rightarrow \bar{\nu}_\mu \rightarrow \mu^+ \quad (\text{appearance}), \quad (5)$$

$$\bar{\nu}_e \rightarrow \bar{\nu}_\tau \rightarrow \tau^+ \quad (\text{appearance}). \quad (6)$$

[Plus 6 corresponding processes for  $\bar{\nu}_\mu$  from  $\mu^+$  decay.]

Processes (2) and (5) are easiest to detect, via the final state  $\mu$ .

Process (5) is noteworthy for having a “wrong-sign”  $\mu$ .

Processes (3) and (6) with a final state  $\tau$  require  $\mu$ 's of 10's of GeV.

Processes (1) and (4) with a final state electron are difficult to distinguish.

Magnetic detectors of 10's of kilotons will be required, with fine segmentation if  $\tau$ 's are to be measured.

# Scaling Laws for Rates at a Neutrino Factory

$\sigma_\nu \propto E$ ;  $I_\nu \propto 1/(\theta)^2 \propto (E/L)^2$ :  $\text{Rate} \propto I_\nu \sigma_\nu \propto E^3/L^2$ .  
 $\Rightarrow \text{Rate} \propto E^3$  at fixed  $L$ ,  $\text{Rate} \propto 1/L^2$  at fixed  $E$ .

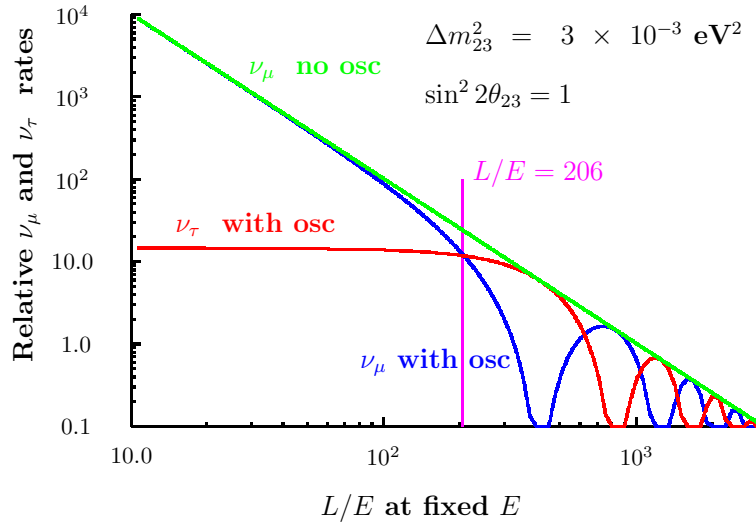

Neutrino oscillation probability varies with  $L/E$ ,  
 $\Rightarrow \text{Rate} \propto E$  for fixed  $L/E$ .

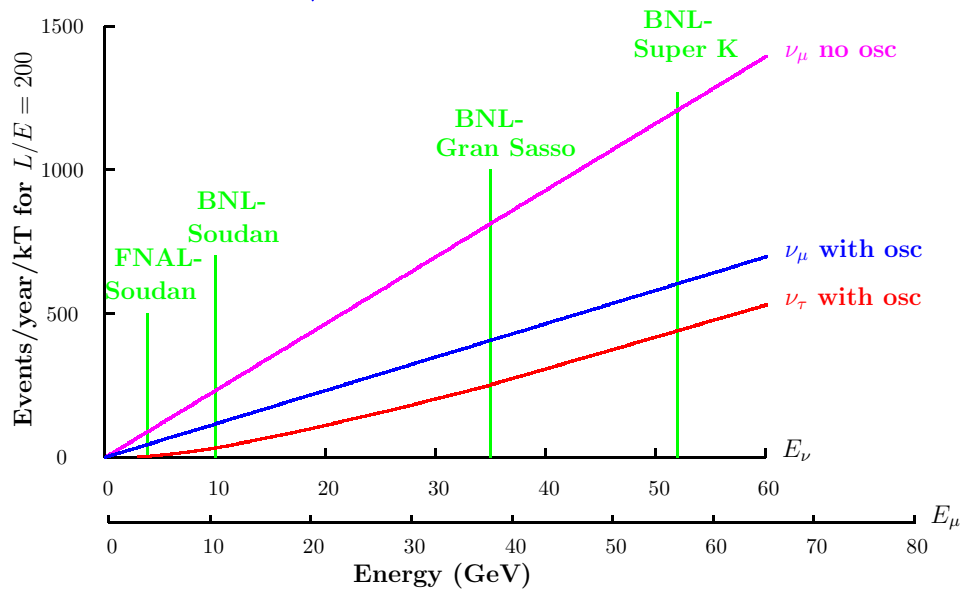

$\tau$  appearance suppressed at low energy. Larger  $E \Rightarrow$  larger  $L$ .

## The Rates are High at a Neutrino Factory

Charged current event rates per kton-yr.

$(L = 732 \text{ km})$	$\nu_\mu$	$\bar{\nu}_e$
Neutrino Factory	$(2 \times 10^{20} \nu_\mu/\text{yr})$	
10 GeV	2200	1300
20 GeV	18,000	11,000
50 GeV	$2.9 \times 10^5$	$1.8 \times 10^5$
250 GeV	$3.6 \times 10^7$	$2.3 \times 10^7$
MINOS (WBB)		
Low energy	460	1.3
Medium energy	1440	0.9
High energy	3200	0.9

Even a low-energy neutrino factory has high rates of electron neutrino interactions.

A neutrino factory with  $E_\mu \gtrsim 20 \text{ GeV}$  is competitive for muon neutrino interactions.

## $\nu_\mu \rightarrow \nu_\mu \rightarrow \mu^-$ Disappearance

$E_\mu = 30$  GeV,  
 $2 \times 10^{20}$   $\mu$  decays,  
 $L = 7000$  km,  
 $\sin^2 2\theta_{23} = 1$ .  
 (hep-ph/9906487)

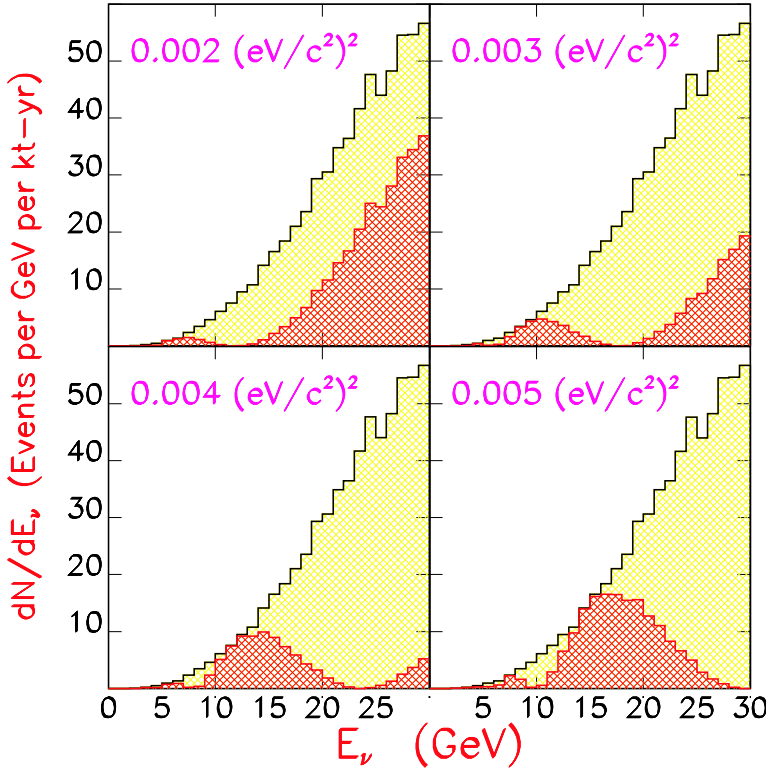

$\Delta m_{23}^2$ (eV <sup>2</sup> )	Events (per 10 kt-yr)
0.002	2800
0.003	1200
0.004	900
0.005	1700
No Osc.	6200

## $\nu_\mu \rightarrow \nu_\tau \rightarrow \tau^-$ Appearance

$\Delta m_{23}^2$ (eV <sup>2</sup> )	Events (per 10 kton-yr)
0.002	1200
0.003	1900
0.004	2000
0.005	1800

For conditions as above.

## Measuring $\theta_{13}$

Many ways:

$$P(\bar{\nu}_e \rightarrow \bar{\nu}_\mu) = \sin^2 2\theta_{13} \sin^2 \theta_{23} \sin^2 \frac{1.27 \Delta m_{23}^2 L}{E_\nu},$$

$$P(\bar{\nu}_e \rightarrow \bar{\nu}_\tau) = \sin^2 2\theta_{13} \cos^2 \theta_{23} \sin^2 \frac{1.27 \Delta m_{23}^2 L}{E_\nu},$$

$$P(\nu_\mu \rightarrow \nu_\tau) = \cos^4 \theta_{13} \sin^2 2\theta_{23} \sin^2 \frac{1.27 \Delta m_{23}^2 L}{E_\nu}.$$

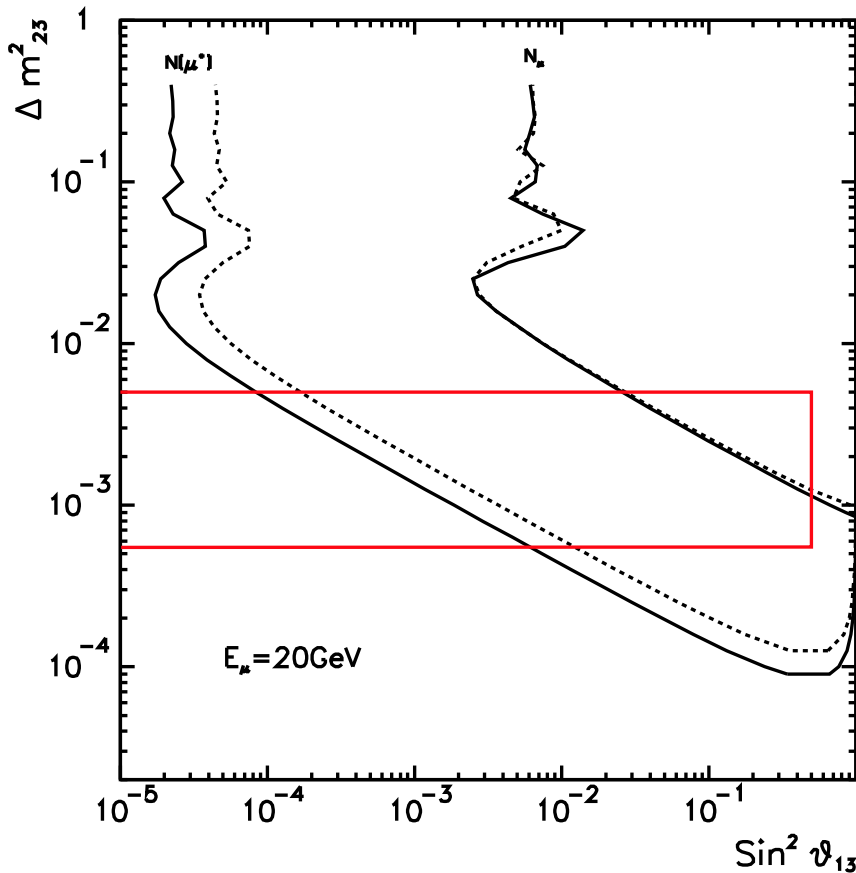

10 kton detector,

$E_\mu = 20$  GeV,

$2 \times 10^{20}$   $\mu$  decays,

$L = 732$  km,

$\sin^2 2\theta_{23} = 1$ ,

Left:  $\bar{\nu}_e \rightarrow \bar{\nu}_\mu \rightarrow \mu^+$ ,

Right:  $\nu_\mu \rightarrow \nu_\mu \rightarrow \mu^-$ ,

Box = presently allowed.

(hep-ph/9811390).

# Measuring the Sign of $\Delta m_{23}^2$ via Matter Effects

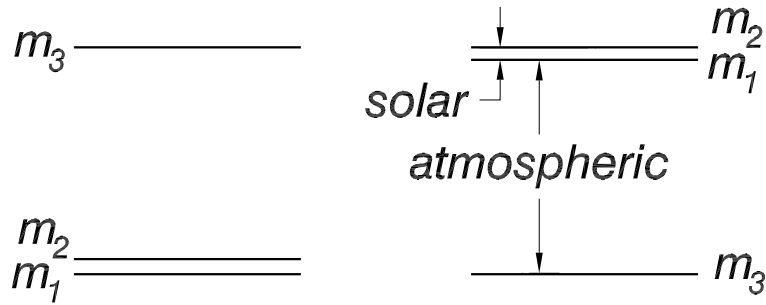

The matter effect resonance depends on the sign of  $\Delta m^2$  (p. 10).

Large effect of  $\Delta m_{23}^2$  in  $\nu_\mu$  (disappearance) if  $\sin^2 2\theta_{13} \approx 0.1$ .

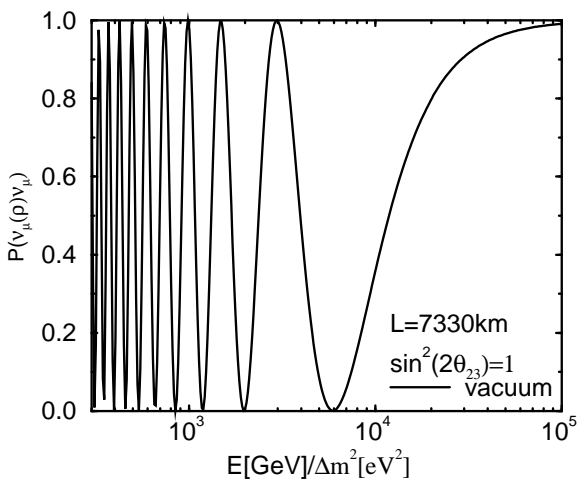

(hep-ph/  
9910554)

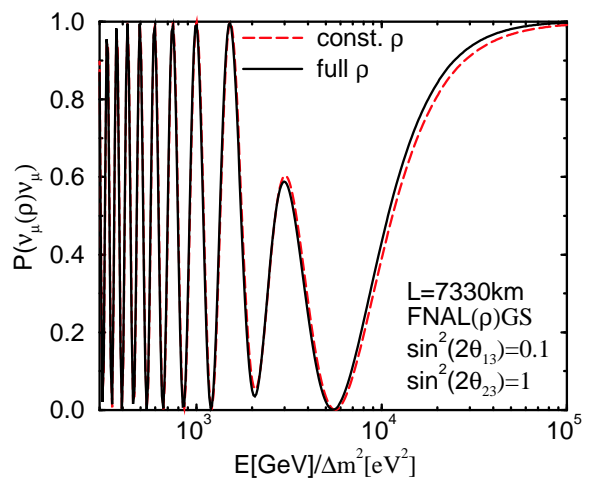

For smaller  $\sin^2 2\theta_{13}$ , may be better to use  $\bar{\nu}_e \rightarrow \bar{\nu}_\mu$  (appearance).

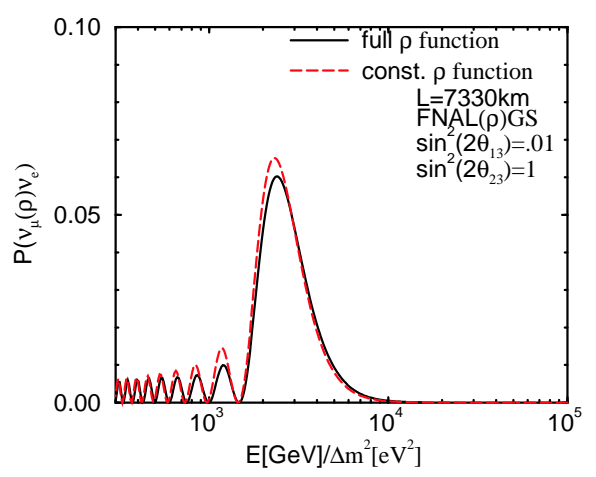
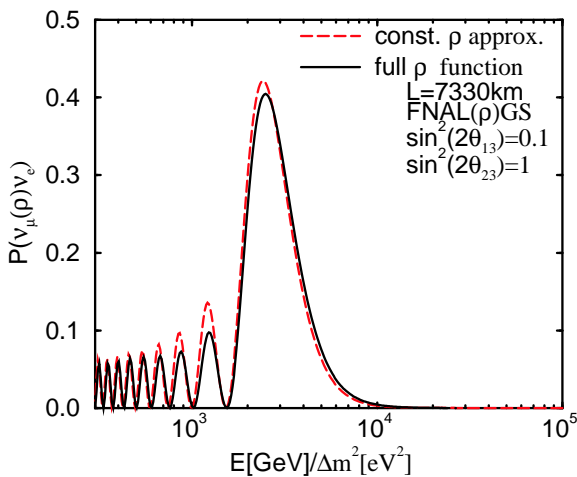

## Measuring $\delta$ via CP Violation

The phase  $\delta$  is accessible to terrestrial experiment in the large mixing angle (LMA) solution to the solar neutrino problem (or if there are 4 massive neutrinos).

CP violation:

$$A_{\text{CP}} = \frac{P(\nu_e \rightarrow \nu_\mu) - P(\bar{\nu}_e \rightarrow \bar{\nu}_\mu)}{P(\nu_e \rightarrow \nu_\mu) + P(\bar{\nu}_e \rightarrow \bar{\nu}_\mu)} \approx \left| \frac{2 \sin \delta}{\sin 2\theta_{13}} \sin \frac{1.27 \Delta m_{12}^2 L}{E} \right|,$$

assuming  $\sin^2 2\theta_{12} \approx \sin^2 2\theta_{23} \approx 1$  (LMA).

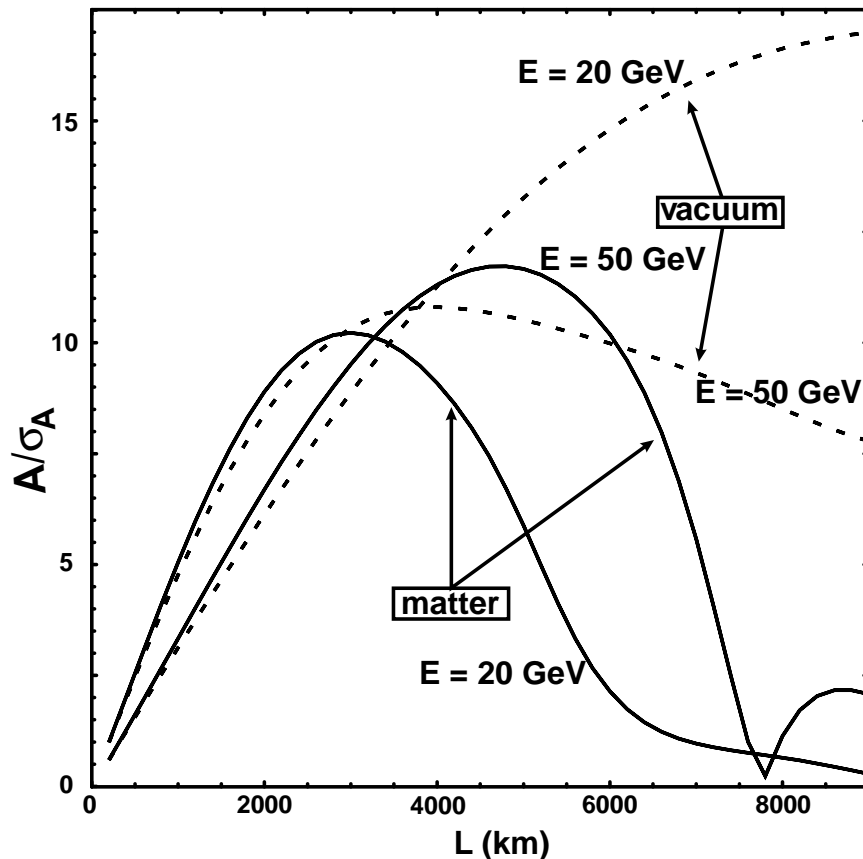

10 kton detector,  
 $2 \times 10^{21}$  muon decays,  
 Large angle MSW:  
 $\Delta m_{12}^2 = 10^{-4} \text{ eV}^2$ ,  
 $\Delta m_{23}^2 = 2.8 \times 10^{-3} \text{ eV}^2$ ,  
 $\theta_{12} = 22.5^\circ$ ,  
 $\theta_{13} = 13^\circ$ ,  
 $\theta_{23} = 45^\circ$ ,  
 $\delta = -90^\circ$ .  
 (hep-ph/9909254)

Matter effects dominate the asymmetry for  $L > 1000$  km.



## Measuring $\delta$ via T Violation

If the small mixing angle (SMA) solutions holds, may still be able to measure  $\delta$  via T violation:

$$P(\nu_e \rightarrow \nu_\mu) - P(\nu_\mu \rightarrow \nu_e) = 4J_{\text{CP}} \sin \frac{1.27\Delta m_{12}^2 L}{E} \sin \frac{1.27\Delta m_{13}^2 L}{E} \sin \frac{1.27\Delta m_{23}^2 L}{E},$$

$$8J_{\text{CP}} = \cos \theta_{13} \sin 2\theta_{13} \sin 2\theta_{12} \sin 2\theta_{23} \sin \delta = \text{Jarlskog invariant.}$$

Matter effects could make  $\sin 2\theta_{12}$  resonate for  $E \approx 100$  MeV and  $L \approx 10,000$  km (hep-ph/9911258).

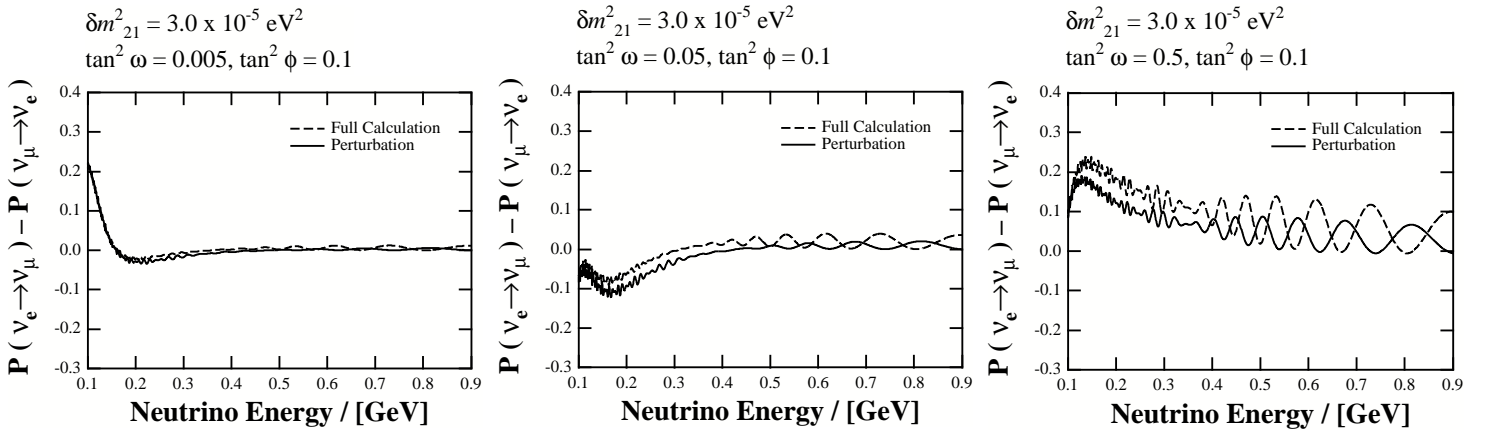

However, not easy to measure  $\nu_\mu \rightarrow \nu_e \rightarrow e^-$  (appearance) against background of  $\bar{\nu}_e \rightarrow \bar{\nu}_e \rightarrow e^+$  in a large, massive detector in which the electrons shower immediately. [Rates low also.]

# Controlling the $\nu_e$ Flux via Muon Polarization

For  $\mu^-$  decay in flight,

$$\frac{dN_{\nu_\mu}(\theta_{\nu_\mu} = 0)}{dx} = 2Nx^2[(3 - 2x) + P(1 - 2x)],$$

$$\frac{dN_{\bar{\nu}_e}(\theta_{\bar{\nu}_e} = 0)}{dx} = 12Nx^2(1 - x)(1 + P),$$

where  $x = 2E_\nu/m_\mu$ , and  $P$  is the muon polarization.

[ $\theta_\nu = 0 \Rightarrow$  collinear decay; at  $P = -1$ , all collinear decays forbidden for  $\theta_{\nu_e} = 0$ , but one is allowed for  $\theta_{\nu_\mu} = 0$ .]

Modulate the muon polarization to modulate the relative rates of  $\nu_\mu \rightarrow \nu_e \rightarrow e^-$  and  $\bar{\nu}_e \rightarrow \bar{\nu}_e \rightarrow e^+$ .

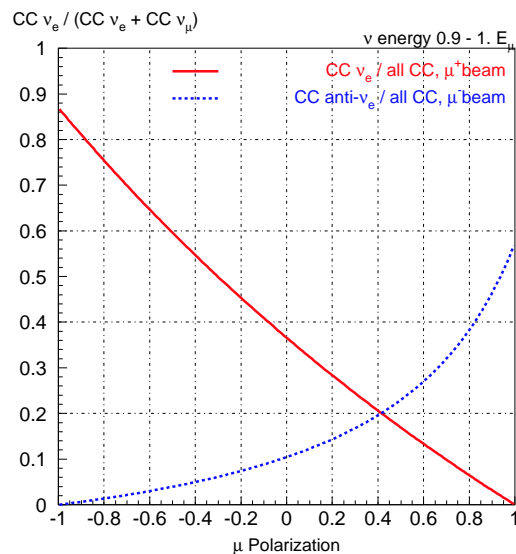
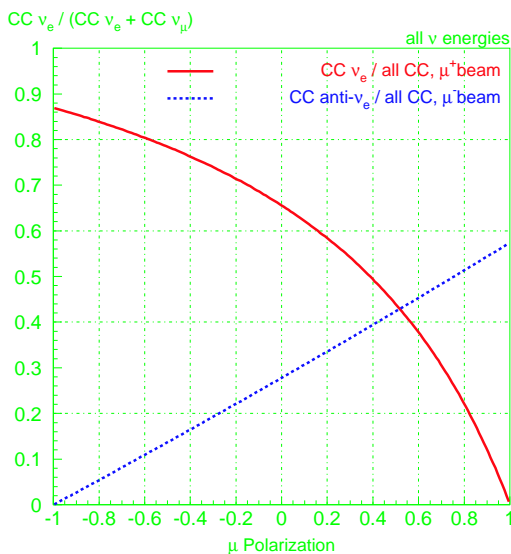

[Geer, P.R. D **67**, 6989 (1998).]

## Many Technical Challenges

- 16-24-GeV proton driver, 15 Hz, 1-4-MW beam power, 1-3-ns bunch length.
- Targetry and capture of  $\approx 10^{14}\pi$  mesons/sec.
- Phase rotation = initial energy compression of the pion cloud.
- **Cooling** = reduction of phase volume of the muon bunch.
- Acceleration.
- **Storage rings.**
- **Neutrino detectors.**

## Cooling, Cooling, Cooling!

O'Neill (1956) noted that “cooling” = reduction of phase volume of particle beams is a key to practical storage rings.

Cooling violates Liouville's theorem (Wigner, 1956), and so must involve a dissipative force.

O'Neill first proposed **ionization cooling**, in which particles lose both longitudinal and transverse momentum in a material, and only longitudinal momentum is replaced by rf fields.

Ionization cooling is only practical for muons, which have very small nuclear interaction rates.

Electrons cool spontaneously via synchrotron radiation; protons can be cooled by stochastic cooling (van der Meer) or by “electron cooling” (Spitzer, Budker). These techniques are too slow for muons

Muons decay ( $\tau = 1 \mu\text{s}$ )! Electron cooling and stochastic cooling are too slow.

# Ionization Cooling

- Ionization: takes momentum away.
- RF acceleration: puts momentum back along  $z$  axis.
- $\Rightarrow$  Transverse “cooling”.

Particles are slowed along their path ( $dE/dx$ )

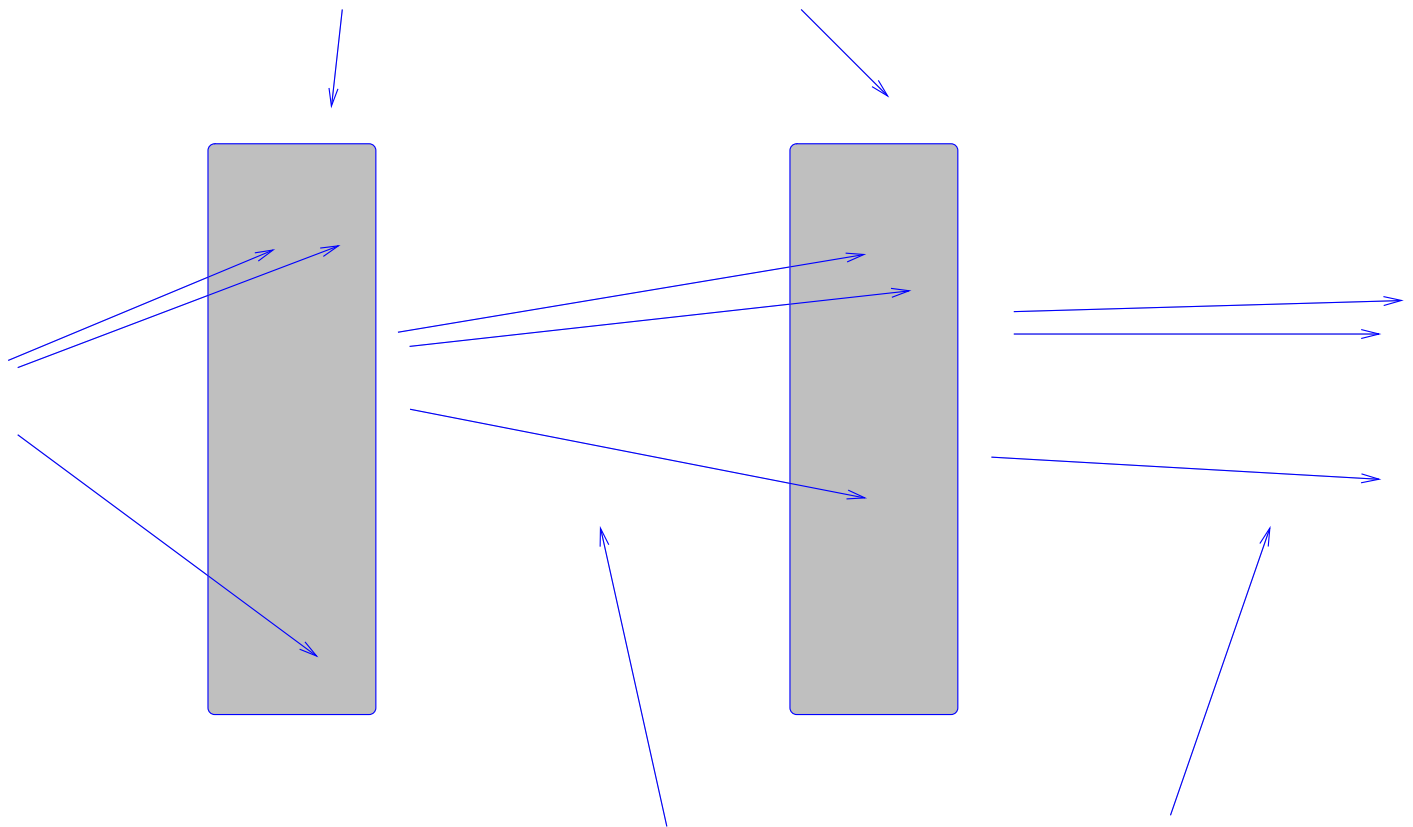

Particles are accelerated longitudinally

- However, multiple Coulomb scattering “heats” the beam.

# Ionization Cooling Theory

Transverse cooling by ionization, heating by multiple scattering:

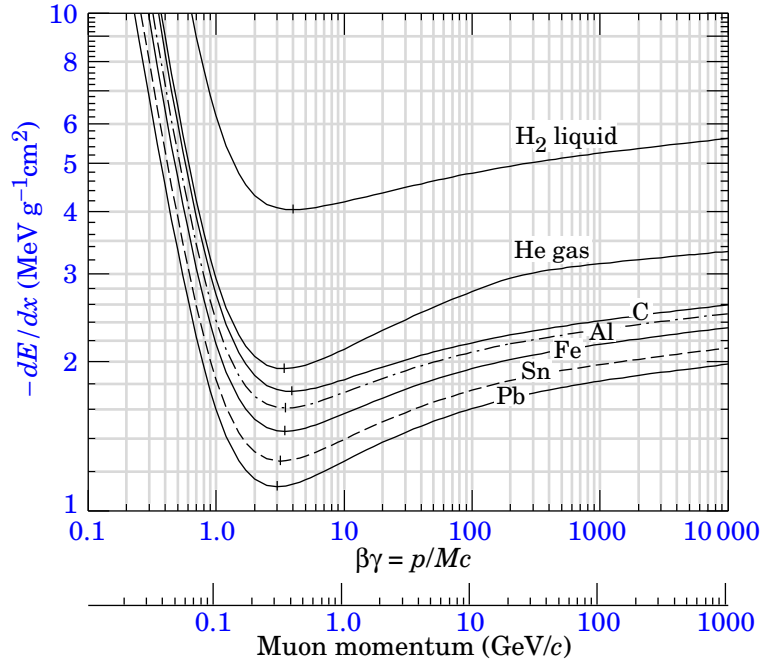

$$\frac{d\epsilon_{N,\perp}}{ds} = -\frac{1}{\bar{\beta}^2} \left| \frac{dE_\mu}{dz} \right| \frac{\epsilon_{N,\perp}}{E_\mu} + \frac{\beta_\perp^* (14 \text{ MeV}/c)^2}{2\bar{\beta}^3 E_\mu m_\mu L_R},$$

$\epsilon_{N,\perp} = \sigma_x \sigma_{P_x} / m_\mu c$  = normalized transverse emittance,

$$\bar{\beta} = \bar{v}/c, \quad \bar{\gamma} = 1/\sqrt{1 - \bar{\beta}^2}$$

$\beta_\perp^* = \sigma_x / \sigma_{x'}$  = Betatron function at the absorber,

$$\epsilon_\perp = \frac{\epsilon_{N,\perp}}{\bar{\gamma}\bar{\beta}}, \quad \sigma_x = \sqrt{\epsilon_\perp \beta_\perp}, \quad \sigma_{x'} = \frac{\sigma_{P_x}}{P} = \sqrt{\frac{\epsilon_\perp}{\beta_\perp}},$$

$L_R$  = Radiation length of absorber.

$$\Rightarrow \text{Minimum } \epsilon_{N,\perp} \propto \frac{\beta_\perp^*}{\bar{\beta} L_R |dE_\mu/dz|}.$$

# Ionization Cooling Optimization

$$\text{Minimum } \epsilon_{N,\perp} \propto \frac{\beta_{\perp}^*}{\bar{\beta} L_R |dE_{\mu}/dz|}.$$

$\Rightarrow$  Low- $Z$  absorber (liquid hydrogen is best),

$\Rightarrow$  Put absorber at low- $\beta_{\perp}^*$  (beam-waist) where angles are large, so multiple scattering hurts less.

Use solenoid magnets to contain large emittance beams.

$\beta_{\perp,\text{solenoid}}^* = 2cP_{\mu}/eB_z$ , so low  $\beta_{\perp}^* \Rightarrow$  high  $B$  solenoids.

Economics favor  $\bar{\beta} < 1$ ,  $\bar{\gamma} \approx 1$ , since must restore the beam energy ( $\propto \bar{\gamma} - 1$ ) many times.

However,  $\beta |dE_{\mu}/dz| \propto \beta^{-2/3}$  for low  $\beta$ , so cooling is less effective at smaller  $\beta$ .

Present scenario: Cool at  $\bar{\beta} = 0.86$ ,  $P_{\mu} = 180 \text{ MeV}/c$ ,  
KE = 100 MeV.

## The Angular Momentum Problem

The **canonical momentum**,  $\Pi = \mathbf{P} + e\mathbf{A}/c$ , of a charged particle is conserved.

A solenoid with field  $B_z$  has vector potential  $A_\phi = rB_z/2$ .

The **canonical angular momentum**  $L$  is also conserved:

$$\mathbf{L} = \mathbf{r} \times \Pi = \mathbf{r} \times (\mathbf{P} + e\mathbf{A}/c).$$

$$\Rightarrow L_z = r\Pi_\phi = rP_\phi + er^2B_z/2c.$$

So, if the mechanical transverse momentum,  $P_\phi$ , has been “cooled” to zero inside the solenoid, the charge will emerge with

$$L_{z,\text{out}} = L_{z,\text{in}} = er^2B_{z,\text{in}}/2c.$$

$\Leftrightarrow$  The fringe field of the solenoid imparts an undesirable kick.



## Solution: Alternating Solenoids

Suppose after leaving field  $B_z$ , the beam enters field  $-B_z$ . Then,

$$er^2 B_{z,\text{in}}/2c = L_{z,1} = L_{z,2} = rP_{\phi,2} - er^2 B_z/2c,$$

$$\Rightarrow P_{\phi,2} = erB_z/c.$$

Now, if cool in region 2 until  $P_{\phi,2} = erB_z/2c$ , and exit, the particle will end up with  $P_{\phi} = 0$ .

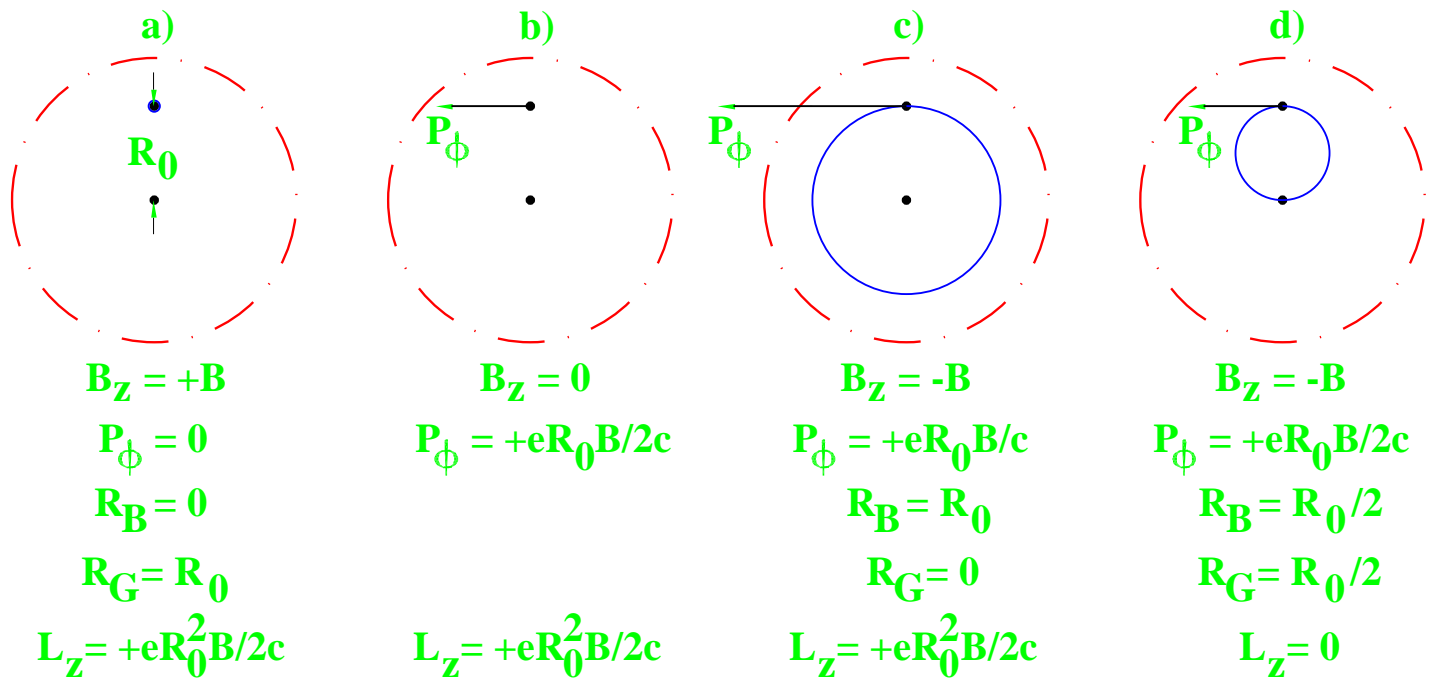

In practice, alternate the fields many times, keeping the canonical momentum always near zero, while the mechanical momentum undergoes damped oscillations.

## The Energy Spread Rises due to “Straggling”

$$\frac{d(\Delta E_\mu)^2}{dz} = -2 \frac{d\left|\frac{dE_\mu}{dz}\right|}{dE_\mu} (\Delta E_\mu)^2 + \frac{d(\Delta E_\mu)_{\text{straggling}}^2}{dz}.$$

- Both terms are positive if  $E_\mu$  is below the minimum of  $dE_\mu/dz$  curve.
- $\Rightarrow$  Must exchange longitudinal and transverse emittance frequently to avoid beam loss due to bunch spreading.
- Can reduce energy spread by a wedge absorber at a momentum dispersion point:

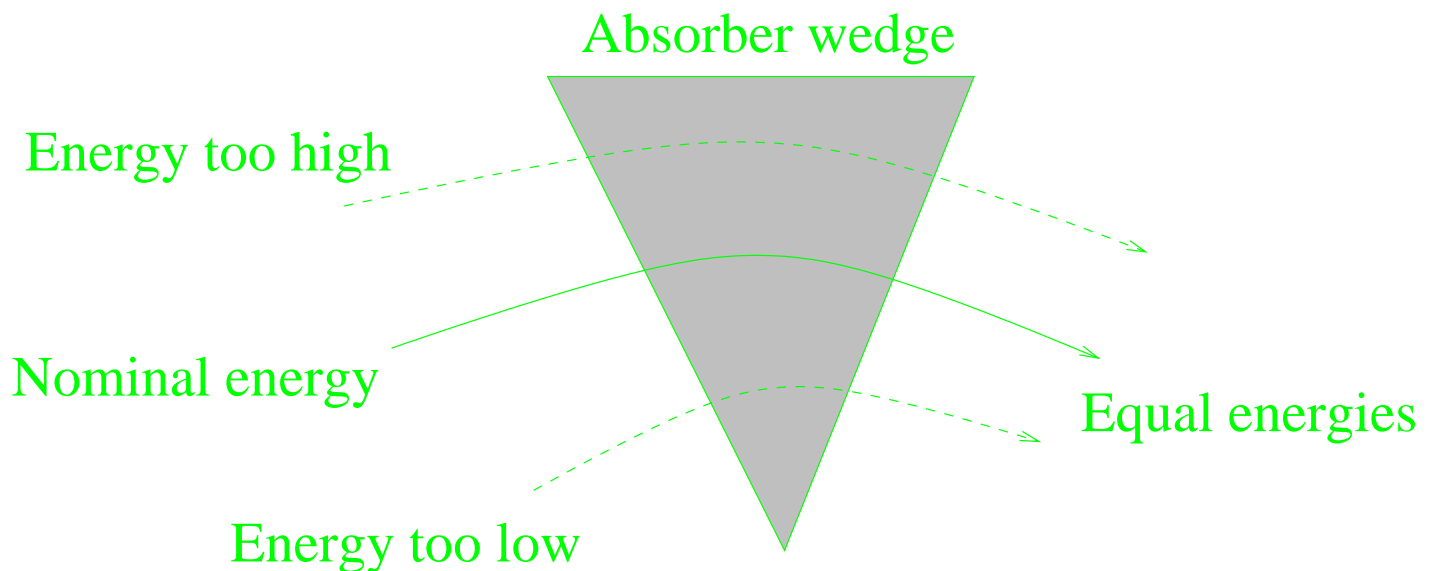

[6-D emittance constant (at best) in this process.]

## Emittance Exchange Via Wedges + Bent Solenoids

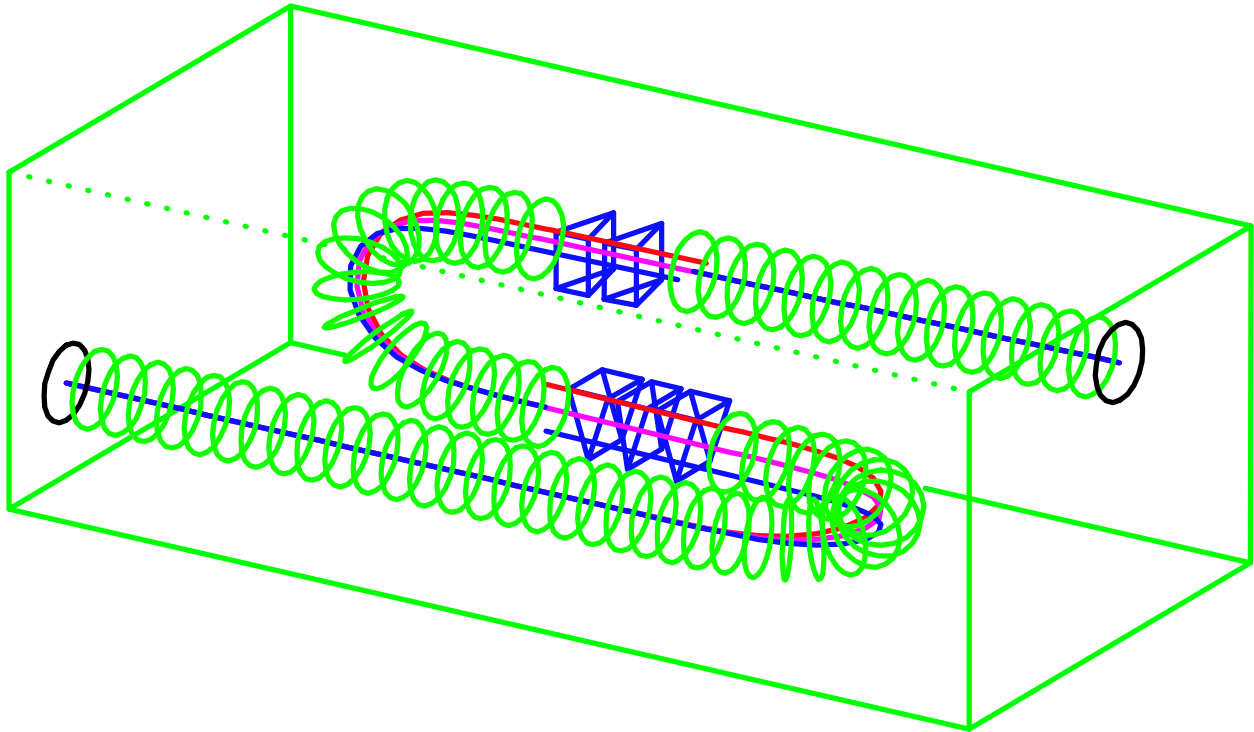

- Difficulty: “Matching” of the different correlations in phase space needed for optimal ionization cooling and emittance exchange.
- $\Rightarrow$  More work needed to master ionization cooling.

## A Neutrino Factory is a Global Facility

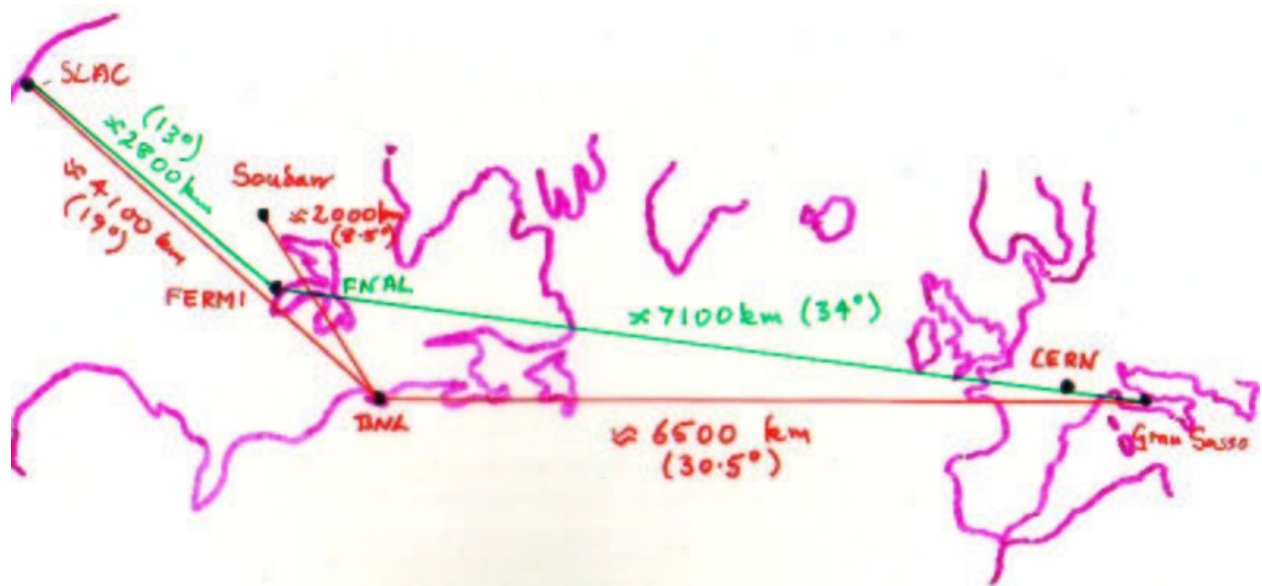

- A host lab contains the muon storage ring and a small, near detector.
- Could have two larger detectors located elsewhere, possibly one on the same, and the second on another continent.
- For this, the muon storage ring needs 3 straight sections, and would not lie in a horizontal plane.

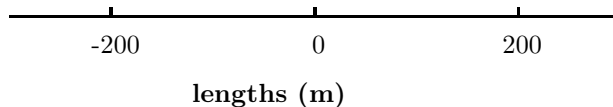
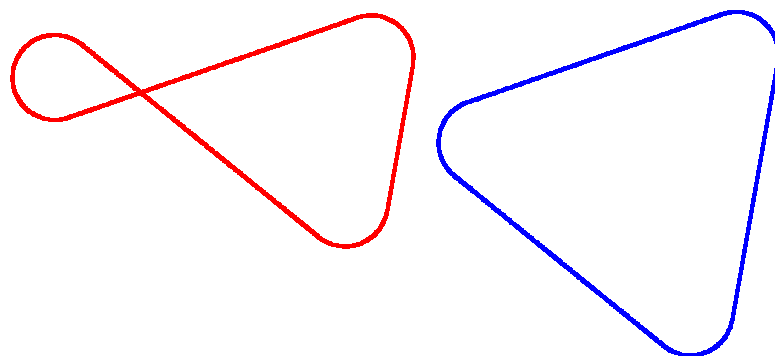

# Large Underground Detectors

K2K:

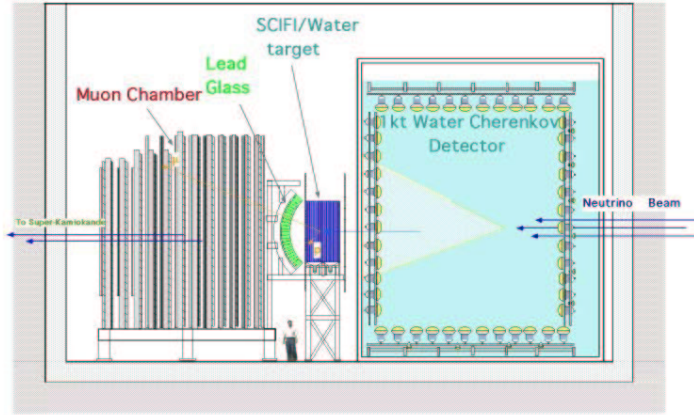

ICANOE:

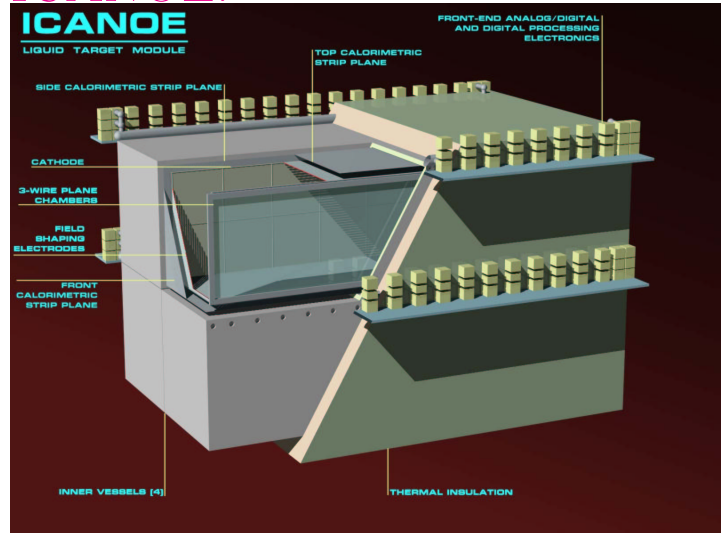

Gran Sasso in Italy:



DOE nuclear waste facility in New Mexico:

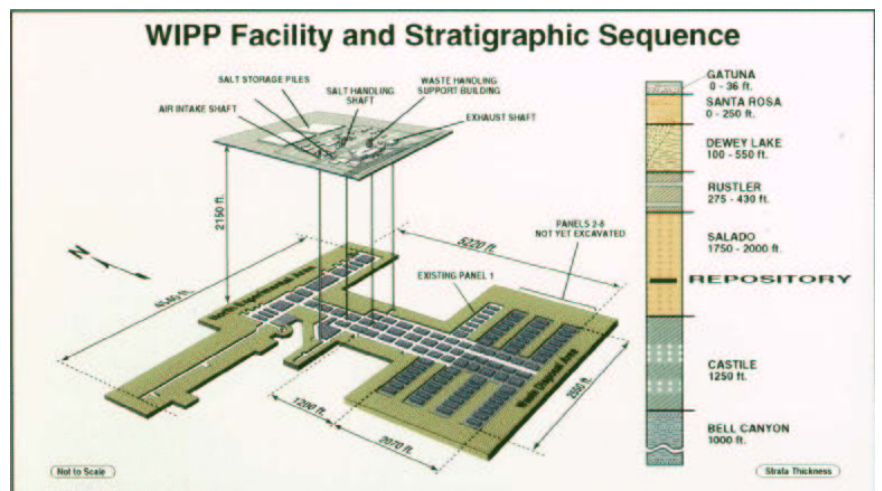

# A Neutrino Factory is a Step to a Muon Collider

- A collider needs more cooling and a different storage ring.
- More affordable than an  $e^+e^-$  collider at the TeV (LHC) scale.
- More affordable than either a hadron or an  $e^+e^-$  collider for (effective) energies beyond the LHC.
- Precision initial state superior even to  $e^+e^-$ .

Muon polarization  $\approx 25\%$ ,

$\Rightarrow$  Can determine  $E_{\text{beam}}$  to  $10^{-5}$  via  $g-2$  spin precession.

$t\bar{t}$  threshold:

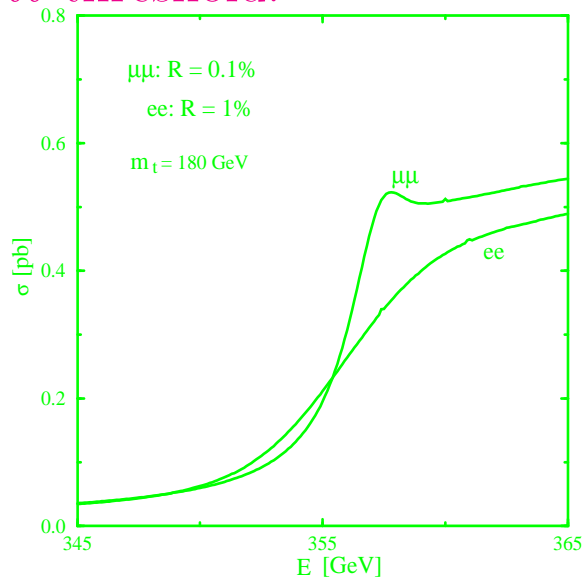

Nearly degenerate  $A^0$  and  $H^0$ :

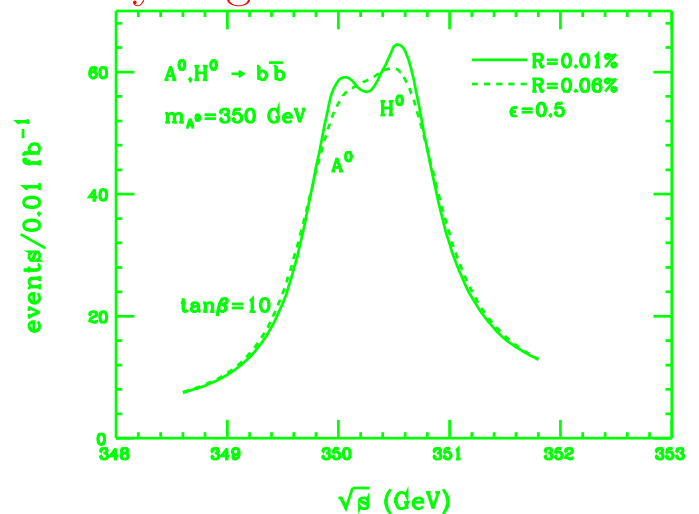

- Initial machine could produce light Higgs via  $s$ -channel:

Higgs coupling to  $\mu$  is  $(m_\mu/m_e)^2 \approx 40,000\times$  that to  $e$ .

Beam energy resolution at a muon collider  $< 10^{-5}$ ,

$\Rightarrow$  Measure Higgs width.

Add rings to 3 TeV later.

# Muon Collider Footprints

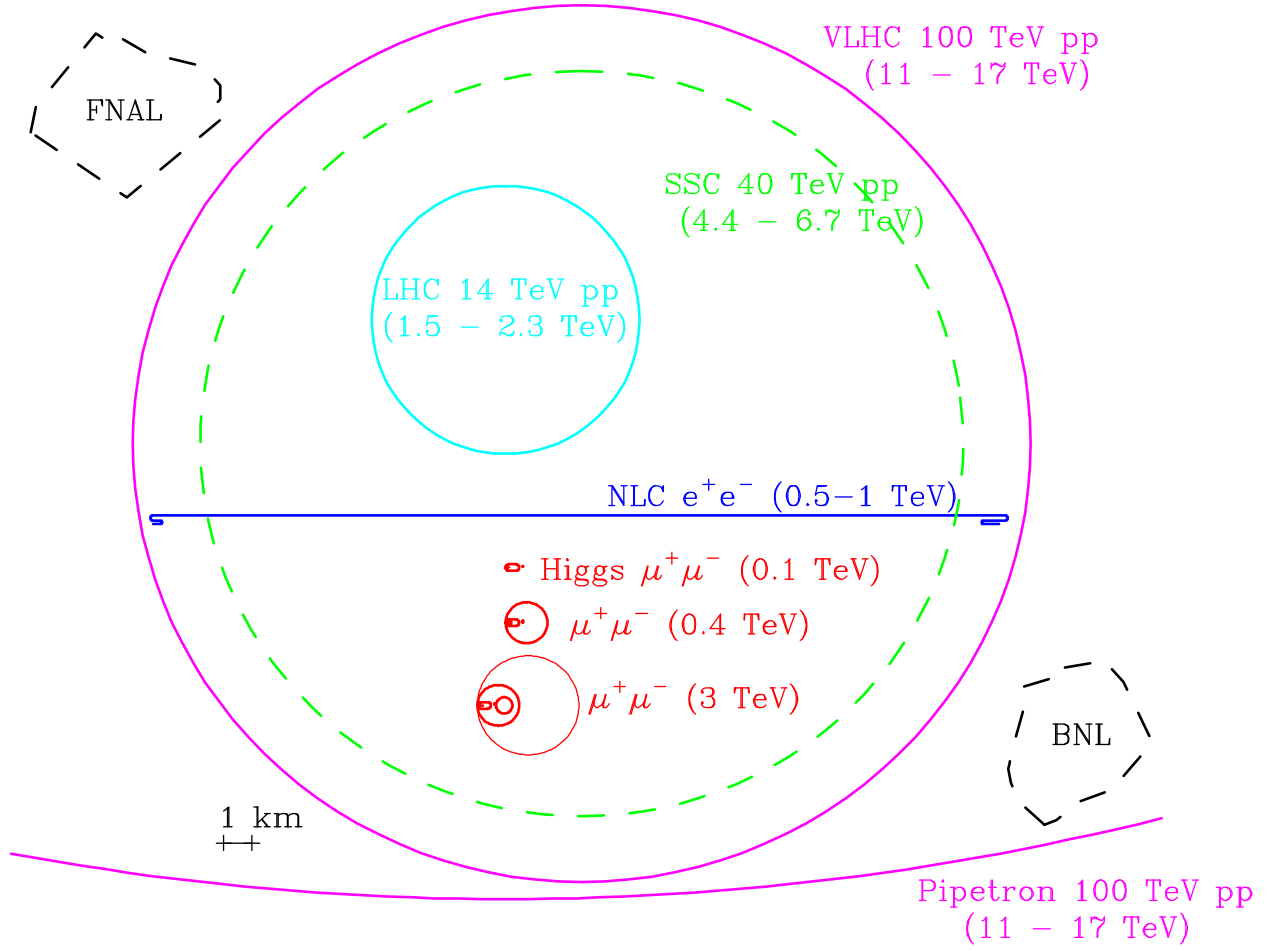

A First Muon Collider to study light-Higgs production:

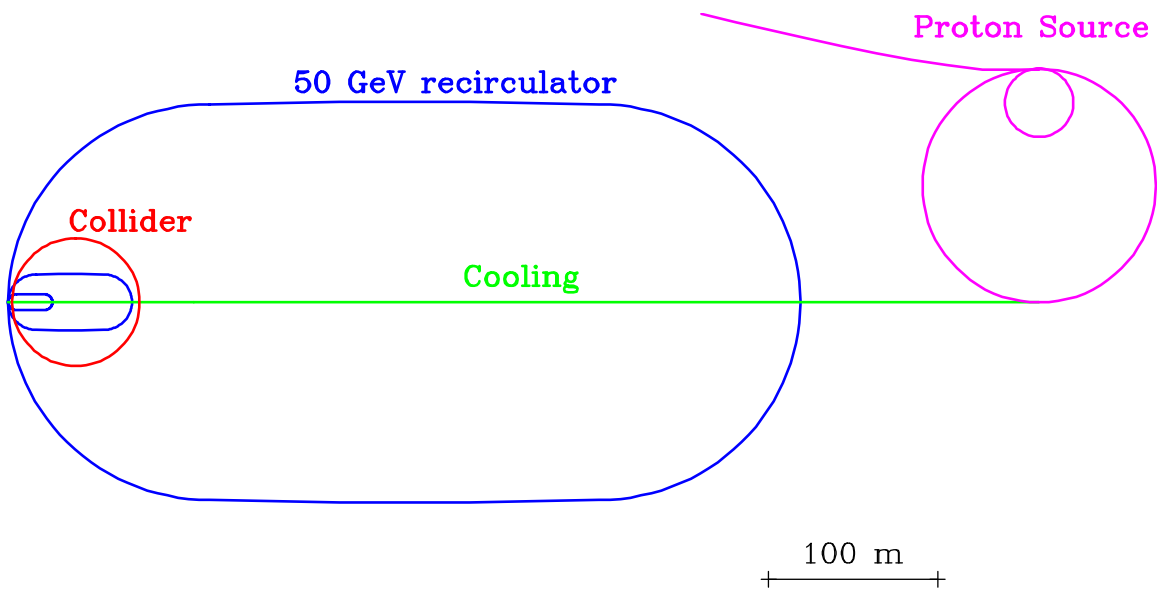

## Summary

- The physics program of a neutrino factory/muon collider is extremely diverse, and of scope to justify an international laboratory.
- The first step is a **neutrino factory** capable of systematic exploration of neutrino oscillations.
  - With  $\gtrsim 10^{20}$   $\nu$ 's/year can go well beyond other existing or planned accelerator experiments.
  - Beams with  $E_{\nu_e} \lesssim 1$  GeV are already very interesting.
  - Higher energy is favored: Rate  $\propto E$  at fixed  $L/E$ ;  $\nu_\tau$  appearance practical only for  $E \gtrsim 30$  GeV.
  - Detectors at multiple distances needed for broad coverage of parameter space  $\Rightarrow$  triangle or “bowtie” storage rings.
  - CP and T violation accessible with  $\gtrsim 10^{21}$   $\nu$ 's/year.
  - Control of muon polarization extremely useful when studying  $\nu_e \rightarrow e$  modes.



